

ICOM

INSTRUCTION MANUAL

DUAL BAND FM TRANSCEIVER
IC-2350H



Icom Inc.

IMPORTANT

READ ALL INSTRUCTIONS carefully and completely before using the transceiver.

SAVE THIS INSTRUCTION MANUAL — This instruction manual contains important operating instructions for the IC-2350H.

EXPLICIT DEFINITIONS

The following explicit definitions apply to this manual.

WORD	DEFINITION
⚠ WARNING	Personal injury, fire hazard or electric shock may occur.
CAUTION	Equipment damage may occur.
NOTE	If disregarded, inconvenience only. No risk of personal injury, fire or electric shock.

CAUTIONS

⚠ WARNING! NEVER connect the transceiver to an AC outlet. This may pose a fire hazard or result in an electric shock.

NEVER connect the transceiver to a power source of more than 16 V DC. This connection will ruin the transceiver.

NEVER cut the DC power cable between the DC plug and fuse holder. If an incorrect connection is made after cutting, the transceiver might be damaged.

NEVER place the transceiver where normal operation of the vehicle may be hindered or where it could cause bodily injury.

NEVER let objects touch the cooling fan on the rear panel.

NEVER allow children to touch the transceiver.

NEVER expose the transceiver to rain, snow or any liquids.

USE Icom microphones only (supplied or optional). Other manufacturers' microphones have different pin assignments and may damage the transceiver.

DO NOT connect the transceiver to a power source using reverse polarity. This connection will not only blow fuses but also damage the transceiver.

DO NOT use or place the transceiver in areas with temperatures below -10°C ($+14^{\circ}\text{F}$) or above $+60^{\circ}\text{C}$ ($+140^{\circ}\text{F}$) or, in areas subject to direct sunlight, such as the dashboard.

AVOID placing the transceiver against walls. This will obstruct heat dissipation.

AVOID the use of chemical agents such as benzine or alcohol when cleaning, as they damage the transceiver surfaces.

BE CAREFUL! The transceiver will become hot when operating continuously for long periods.

UNPACKING

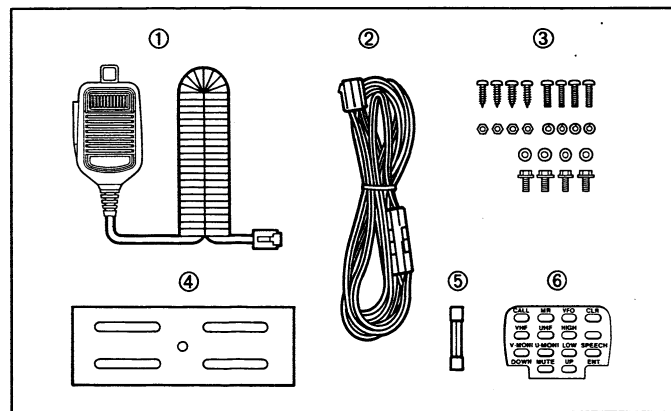

Accessories included with the transceiver:	Qty.
① Microphone*	1
② DC power cable (OPC-346)	1
③ Mounting screws, nuts and washers	1 set
④ Mobile mounting bracket	1
⑤ Fuse (20 A)	1
⑥ Microphone sheet (U.S.A. version only)	1

* U.S.A. version : HM-95 DTMF MICROPHONE
 Europe and Italy versions : HM-97 HAND MICROPHONE
 (with 1750 Hz tone)
 Asia version : HM-96 HAND MICROPHONE

TABLE OF CONTENTS

IMPORTANT	i
EXPLICIT DEFINITIONS	i
CAUTIONS	i-ii
UNPACKING	ii
TABLE OF CONTENTS	iii-iv
1 PANEL DESCRIPTION	1-6
■ Front panel	1
■ Function display	3
■ Rear panel	5
■ Microphone	6
2 INSTALLATION	7-10
■ Location	7
■ Mounting	7
■ Battery connection	8
■ DC power supply connection	8
■ Antenna installation	9
■ Optional unit installation	10
3 FREQUENCY SETTING	11-13
■ Pre-operation	11
■ Using the tuning dials	12
■ Using [UP]/[DN] switches	12
■ Frequency lock function	13
■ Tuning step selection	13
4 BASIC OPERATION	14-15
■ Receiving	14
■ Transmitting	15
5 REPEATER OPERATION	16-18
■ Accessing	16
■ Tone frequency	17
■ Offset frequency	17
■ Auto repeater	18
■ Tone scan	18
6 MEMORY AND CALL CHANNELS	19-23
■ General description	19
■ Memory channel selection	19
■ Programming without checking the overwriting channel	20
■ Programming after selecting a memory or call channel	21
■ Transferring memory contents into the VFO	21
■ Transferring memory or call channel contents	22
■ Auto channel advance	23
■ Calling up a call channel	23
7 SCRATCH PAD MEMORY	24
■ What is a scratch pad memory	24
■ Calling up a scratch pad memory	24

8 SCAN OPERATION	25–30	14 OPTIONAL DTMF REMOTE	40–43
■ Scan types	25	■ General description	40
■ Full scan and programmed scan	26	■ Mic DTMF remote operation	40
■ Programming scan edges	27	■ External DTMF remote presetting	41
■ Scan type selection	28	■ External DTMF remote operation	41
■ Memory scan	28	■ Remote function table	42
■ Skip channel setting	29	■ Remote operation examples	43
■ Scan resume condition	30	15 OTHER FUNCTIONS	44–46
9 PRIORITY WATCH	31–32	■ Display dimmer setting	44
■ Priority watch types	31	■ Beep tones	44
■ Priority watch operation	32	■ Time-out timer	45
10 SUB BAND FUNCTIONS	33	■ Auto power-off	45
■ Sub band access	33	■ Cooling fan setting	46
■ Sub band mute/sub band busy beep	33	■ Mono band operation	46
11 UP/DN SWITCH REMOTE	34	■ Demonstration display	46
■ Assigning a function to the [UP] or [DN] switch	34	16 MODE ARRANGEMENT CHART	47–48
12 PAGER AND CODE SQUELCH	35–38	17 MAINTENANCE	49–51
■ General description	35	■ Troubleshooting	49
■ Code programming	36	■ Fuse replacement	50
■ Pager operation	37	■ Partial resetting	51
■ Code squelch operation	38	■ Total resetting	51
13 POCKET BEEP AND TONE SQUELCH	39	18 SPECIFICATIONS	52
■ Pocket beep operation	39	19 OPTIONS	53–54
■ Tone squelch operation	39	■ Options	53

1

PANEL DESCRIPTION

■ Front panel

Most switches have primary and secondary functions. When pushed momentarily, the primary function is selected. When pushed for 2 sec., the secondary function is selected.

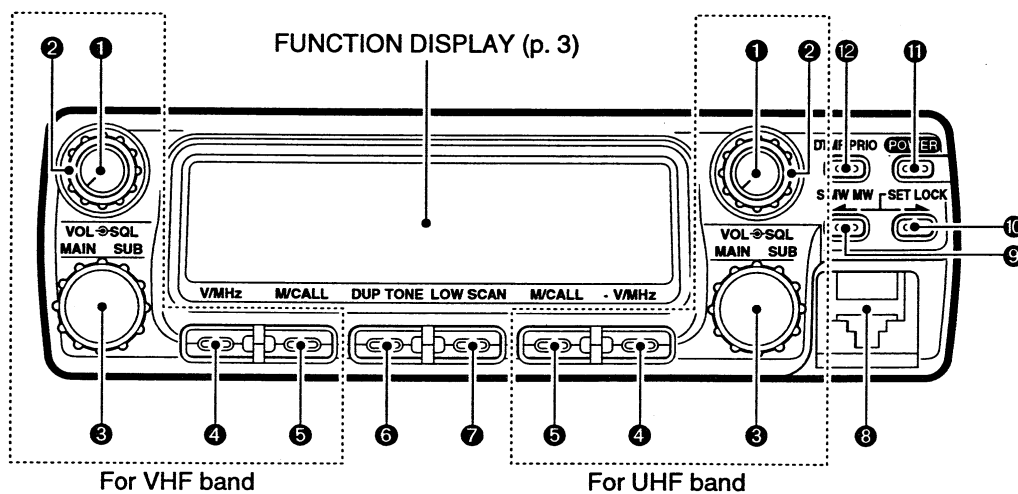

① VOLUME CONTROLS [VOL]

- Adjust the audio level. (p. 14)
- Open the squelch and monitor the transmit frequency when pushed and held. (pgs. 14, 16)

② SQUELCH CONTROLS [SQL]

- Adjust the squelch threshold level.
- Activate the RF attenuator (10 dB max.) when rotated further than 12 o'clock. (p. 14).

③ TUNING DIALS [MAIN•SUB]

- Select an operating frequency or memory channel. (pgs. 12, 19)
- Select a scratch pad memory when a call channel is selected. (p. 24)
- Assign the main band when pushed. (p. 11)
- Activate and cancel the sub band access function when pushed for 2 sec. (p. 33)

④ VFO/MHz SWITCHES [V/MHz]

- Select VFO mode when a memory channel, call channel or scratch pad memory is selected. (p. 11)
- Select the 1 MHz tuning step while in VFO mode is selected. For some versions, select the 10 MHz tuning step and 1 MHz tuning step. (p. 12)

⑤ MEMORY/CALL CHANNEL SWITCHES [M/CALL]

Select memory mode or a call channel. (pgs. 19, 23)

⑥ DUPLEX/TONE SWITCH [DUP•TONE]

- Selects simplex, "DUP-" or "DUP." (p. 16)
- Activates the subaudible tone encoder when pushed for 2 sec. (p. 16)
- After installing an optional UT-89, alternately selects the subaudible tone encoder, pocket beep and tone squelch function when pushed for 2 sec. (pgs. 16, 39)

⑦ LOW POWER/SCAN SWITCH [LOW•SCAN]

When pushed momentarily		Alternately selects low power 1, 2 and high power. (p.15)
When pushed and held	While in VFO mode	Starts full scan or programmed scan. (p. 26)
	While in memory mode	Starts memory scan. (p. 28)
	While the optional tone squelch is in use	Starts the tone scan function. (p. 18)

⑧ MICROPHONE CONNECTOR (See p. 6 for details.)

⑨ SELECT MEMORY WRITE/MEMORY WRITE SWITCH [S.MW•MW]

- Selects the desired memory channel number to be programmed when pushed momentarily. (p. 20)
- Programs a memory channel or call channel when pushed for 2 sec. while in VFO mode. (pgs. 20, 21)
- Transfers a memory channel, call channel or scratch pad memory contents into the VFO when pushed for 2 sec. (pgs. 21, 22)

⑩ SET/LOCK SWITCH [SET•LOCK]

- Selects SET mode. (p. 48)
- Selects full or programmed scan while scanning in VFO mode. (p. 26)
- Activates and cancels the frequency lock function when pushed for 2 sec. (p. 13)

⑪ POWER SWITCH [POWER]

- Turns the power ON and OFF when pushed for 2 sec. (p. 11)
- Some settings can be performed at power ON when other switches are pushed simultaneously. (pgs. 18, 44-46)

⑫ DTMF/PRIORITY WATCH SWITCH [DTMF•PRIO]

- Activates and cancels the optional pager, code squelch function or remote standby condition. (pgs. 37, 38, 40)
- Activates the priority watch function when pushed for 2 sec. (p. 32)
- Cancels the priority watch function. (p. 32)

1 PANEL DESCRIPTION

■ Function display

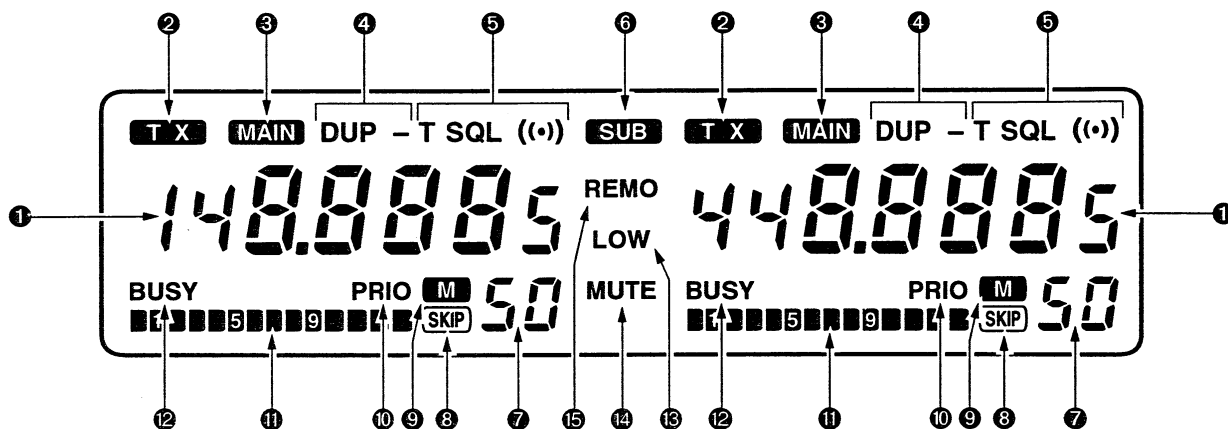

❶ FREQUENCY READOUTS

Show the operating frequency, set mode contents, etc.

- The decimal point of the frequency flashes while scanning. (pgs. 26; 28)
- "P" or "C" appears in place of the 100 MHz digit while the optional pager or code squelch function is in use, respectively. (pgs. 37, 38)

❷ TRANSMIT INDICATORS (p. 15)

Appear while transmitting.

❸ MAIN BAND INDICATORS (p. 11)

Appear above a frequency readout to show the main band for transmitting and function control.

❹ DUPLEX INDICATORS (p. 16)

"DUP-" or "DUP" appear during semi-duplex operation (repeater operation).

⑤ TONE INDICATORS

- “T” appear while the subaudible tone encoder is in use. (p. 16)
- “T SQL” appear while the optional tone squelch function is in use. (p. 39)
- “T SQL (•)” appear while the optional pocket beep function is in use. (p. 39)

⑥ SUB BAND ACCESS INDICATOR

- Appears when the sub band access function is in use. (p. 33)
- Flashes while optional external DTMF remote is in use. (p. 41)

⑦ MEMORY CHANNEL READOUTS

- Show the selected memory channel numbers. (p. 19)
- Only 2 large “L” ’s appear while the frequency lock function is in use. (p. 13)
 - A large “C” appears while on a call channel. (p. 23)
 - “r1” appears while a duplex scratch pad memory is selected. (p. 24)
 - “L1” appears while a simplex scratch pad memory is selected. (p. 24)
 - A small “c” appears when VFO mode is selected from the call channel or a scratch pad memory. (pgs. 23, 24)
 - Flashes while in select memory write mode. (p. 20)

⑧ SKIP INDICATORS (p. 29)

Appear when the displayed memory channel is specified as a skip channel while in memory mode.

⑨ MEMORY INDICATORS (p. 19)

Appear when memory mode is selected.

⑩ PRIORITY WATCH INDICATORS (p. 32)

Appear while the priority watch is activated; flash while the watch is paused.

⑪ S/R/F INDICATORS

- Show the relative signal strength while receiving. (p. 14)
- Show the output power selection while transmitting. (p. 15)

⑫ BUSY INDICATORS (p. 14)

Appear while a signal is being received or the squelch is open.

⑬ LOW POWER INDICATOR (p. 15)

Appears while low output power 1 or 2 is selected for the main band.

⑭ AUDIO MUTE INDICATOR (p. 42)

Appears while the audio mute function is activated in the optional DTMF remote.

- The optional UT-101 and a DTMF microphone (HM-95, HM-77, etc.) is required to use the DTMF remote.

⑮ REMOTE INDICATOR (p. 40)

Appears while mic DTMF remote is in standby. Flashes while the function is activated.

1 PANEL DESCRIPTION

■ Rear panel

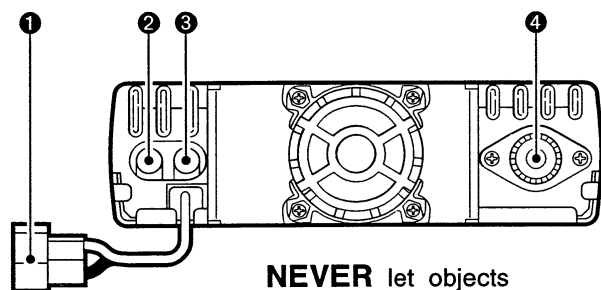

NEVER let objects touch the cooling fan.

❶ DC POWER RECEPTACLE [DC13.8V] (p. 8)

Accepts 13.8 V DC with the supplied DC power cable.
- 12 A or more current capacity is necessary.

NOTE: DO NOT use a cigarette lighter socket as a power source when mounting in a vehicle. The plug may cause voltage drops and ignition noise may be superimposed onto transmit or receive audio.

❷ 430 (440) MHz SPEAKER JACK [430MHz (440MHz) SP]

Connects 4–8 Ω speaker, if required.

❸ 140 MHz SPEAKER JACK [144MHz SP]

Connects 4–8 Ω speaker, if required.

❹ ANTENNA CONNECTOR (p. 9)

Accepts a 50 Ω dual band antenna with a PL-259 connector.

ANTENNA INFORMATION

For radio communications, the antenna is of critical importance, along with output power and sensitivity. The transceiver accepts a 50 Ω antenna and less than 1.5:1 of Voltage Standing Wave Ratio (VSWR). High SWR values not only may damage the transceiver but also lead to TVI or BCI problems.

◇ Speaker jack information

Connected speaker	VHF band audio	UHF band audio
With no external speakers	Internal speaker (mixed audio)	
[144MHz SP] only	External speaker	Internal speaker
[430(440) MHz SP] only	External speaker (mixed audio)	
2 external speakers	External speaker via [144MHz SP]	External speaker via [430(440) MHz SP]

Microphone

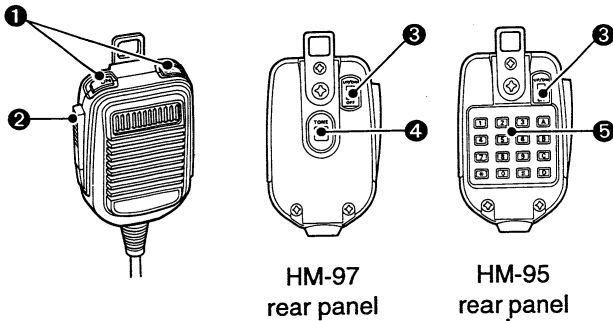

HM-97
rear panel

HM-95
rear panel

① UP/DOWN SWITCHES [UP]/[DN]

- Change the frequency or memory channel in VFO or memory mode, respectively. (pgs. 12, 19)
- Select scratch pad memory when selecting the call channel. (p. 24)
 - [UP] for duplex and [DN] for simplex.
- Start and stop the scan function when pushed for 2 sec.
- When the "[UP]/[DN] switch remote" is assigned, [UP] or [DN] activates the programmed function. (p. 34)
- When the "DTMF remote" is in standby,* [UP] activates the remote control function. (HM-95 or optional DTMF microphone is necessary for control.)
 - *An optional UT-101 DTMF UNIT is necessary.

② PTT SWITCH (p. 15)

Push and hold to transmit; release to receive.

③ UP/DOWN OFF SWITCH [UP/DN OFF] (p. 12)

Deactivates the [UP]/[DN] switch function to prevent accidental frequency change.

④ TONE CALL SWITCH [TONE] (HM-97 only, p. 16)

Push and hold to transmit a 1750 Hz tone burst signal for repeater access.

⑤ DTMF KEYPAD (HM-95 only, pgs. 16, 40)

Sends a DTMF code while pushing the PTT switch.

◇ Microphone connector information

(front panel view)

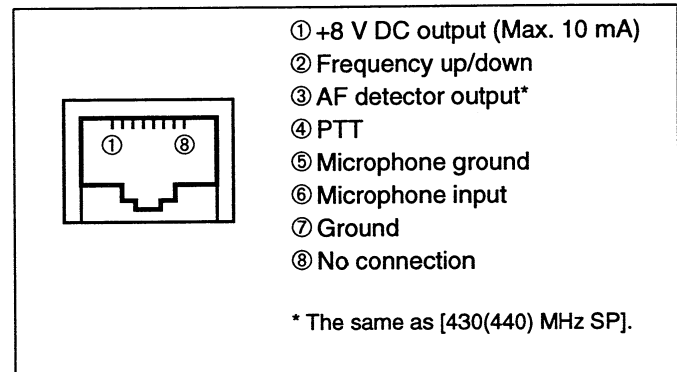

2

INSTALLATION

■ Location

Select a location which can support the weight of the transceiver and does not interfere with driving in any way. We recommend the locations shown in the diagram below.

- ⚠ **NEVER** place the transceiver where normal operation of the vehicle may be hindered or where it could cause bodily injury.
- ⚠ **NEVER** place the transceiver where air bag operation may be obstructed.
- DO NOT** place the transceiver where hot or cold air blows directly onto it.
- AVOID** placing the transceiver in direct sunlight.

• EXAMPLE INSTALLATION LOCATIONS

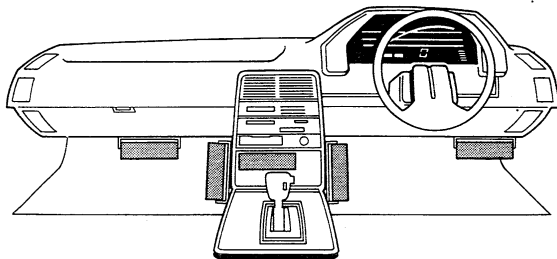

■ Mounting

- ① Drill 4 holes where the mounting bracket is to be installed.
 - When using nuts: 5.5–6 mm; 7/32–1/4 in
 - When using self-tapping screws: 2–3 mm; 3/32–1/8 in
- ② Insert the supplied screws, nuts and washers through the mounting bracket and tighten.
- ③ Adjust the angle for the clearest view of the function display.

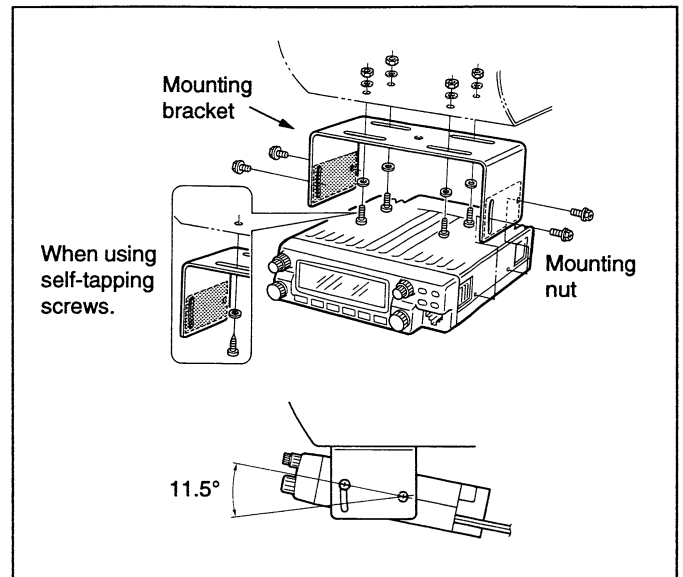

■ Battery connection

- ⚠ **NEVER** connect the transceiver directly to a 24 V battery.
- ⚠ **NEVER** use the cigarette lighter socket for power connections.
- Attach a rubber grommet when passing the DC power cable through a metal plate to prevent short circuits.

■ DC power supply connection

Use a 13.8 V DC power supply with more than 12 A capability. An optional IC-PS30 DC POWER SUPPLY is available for using the transceiver with a DC power supply in your home.

Make sure the ground terminal of the DC power supply is grounded.

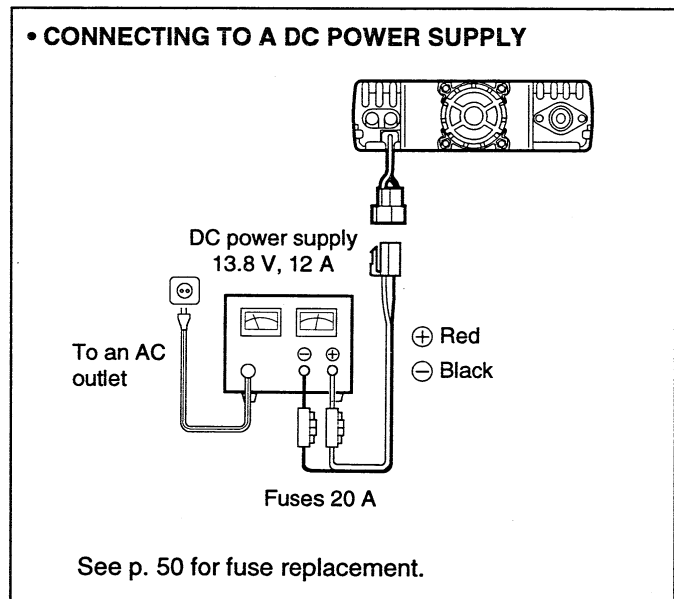
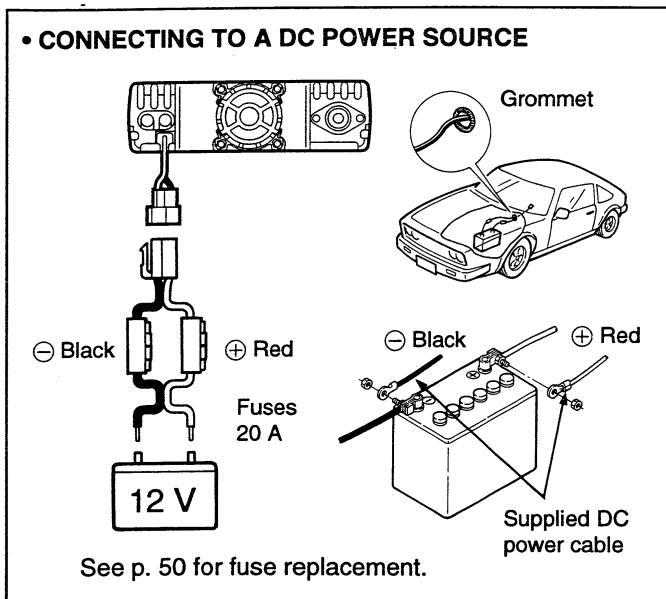

2 INSTALLATION

■ Antenna installation

◇ Antenna location

You can use a dual band antenna because the IC-2350H has a built-in duplexer.

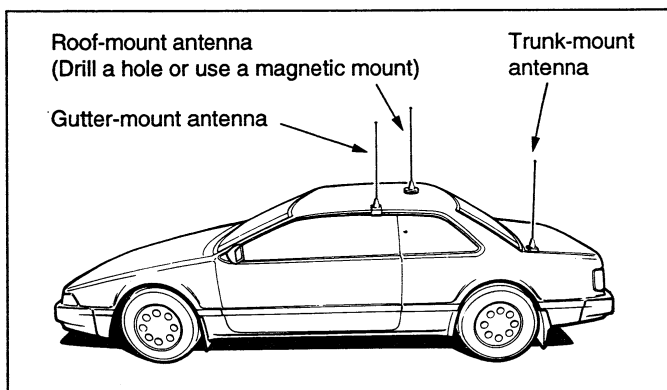

◇ Mono band antenna connection

An external duplexer must be connected when using a separate antenna for each band.

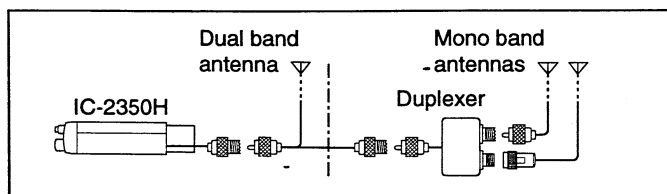

◇ Antenna connector

The antenna connector uses a PL-259 connector.

- ① Slide the coupling ring over the coaxial cable.

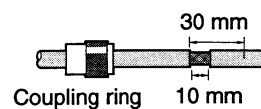

- ② Strip the cable, and soft solder the center conductor.

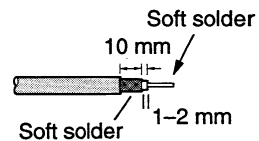

- ③ Slide the connector body onto the cable and solder.

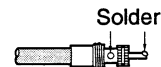

- ④ Screw the coupling ring onto the connector body.



30 mm \approx 9/8 in
10 mm \approx 3/8 in
1-2 mm \approx 1/16 in

■ Optional unit installation

There are 2 types of optional internal units available.

- **UT-89 TONE SQUELCH UNIT** (pgs. 18, 39)
Provides pocket beep, tone squelch and tone scan functions.
- **UT-101 DTMF ENCODER/DECODER UNIT**
(pgs. 37, 38, 40)
Provides pager and code squelch functions. Also “DTMF remote” for controlling the transceiver via a DTMF microphone.

For installation, proceed as follows:

⚠ **WARNING!** Wear working gloves when removing the bottom cover to protect your hands. **BE CAREFUL!** The bottom cover may be tight and the edges are sharp.

- ① Turn power OFF, then disconnect the DC power cable.
- ② Unscrew the 1 screw, then remove the bottom cover as shown in the diagram at right. (Fig. 1)
- Use an appropriate tool as a lever.
- ③ Install the optional unit as shown in the diagram at right. (Fig. 2)
- ④ Replace the bottom cover and screw, then the DC power cable.

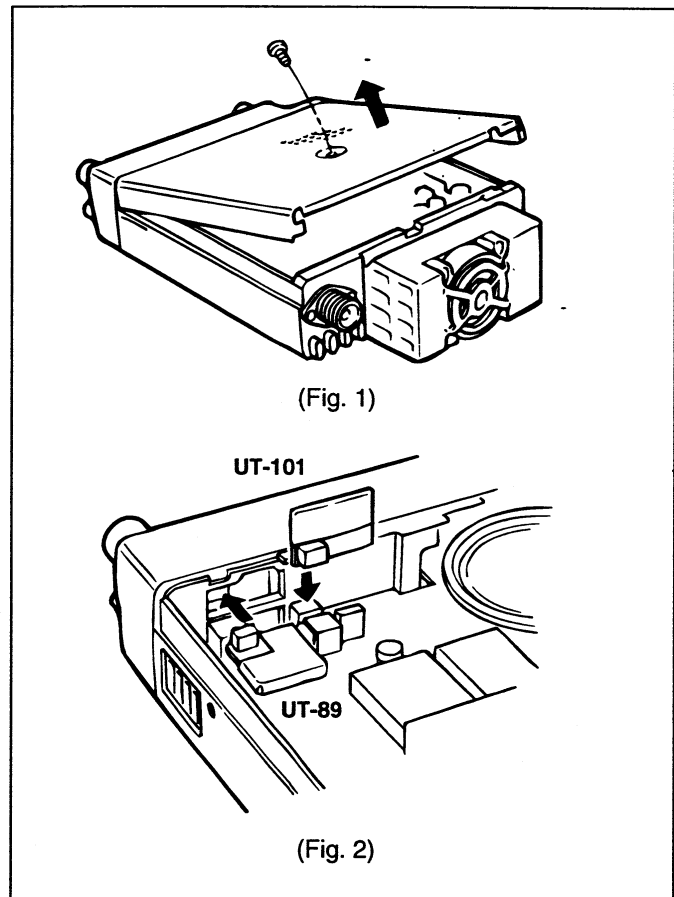

3

FREQUENCY SETTING

■ Pre-operation

◇ Turning power ON/OFF

Push and hold [POWER] for 2 sec. to turn power ON or OFF.

Push and hold [POWER] for 2 sec.

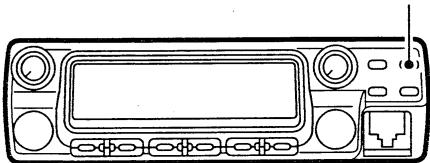

/// If auto power-off is in use, the transceiver automatically turns the power OFF after a selected period in which no switches or tuning dials are operated. (p. 45)

◇ Main band

The IC-2350H can receive 144 MHz and 430(440) MHz band signals simultaneously. To activate all functions or to change frequency via the microphone, you must designate one band as the main band. The transceiver can transmit a signal on the main band only.

Push the desired band's tuning dial to select the main band.
- "**MAIN**" indicator shows the selected band as the main band.

◇ VFO and memory modes

The transceiver has 2 normal operating modes: VFO mode and memory mode. You can select VFO mode or memory mode independently on each band.

Push the desired band's [V/MHz] to select VFO mode when the transceiver is not in VFO mode.

- If VFO mode is already selected, the digits below 100 kHz disappear. In this case, push [V/MHz] again.

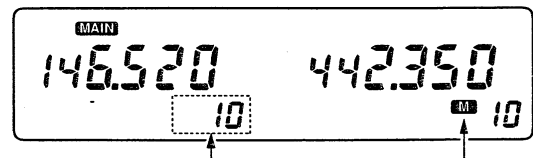

VFO mode is selected. Indicates memory mode.

■ Using the tuning dials

- ① Select VFO mode with the desired band's [V/MHz].
- ② Rotate the selected band's tuning dial.
 - Frequency changes according to the selected tuning steps. (p. 13)

◇ 1 MHz tuning step (Europe version)

Push the selected band's [V/MHz] to select 1 MHz tuning step. Push [V/MHz] again to return to the previous tuning step.

◇ 10 MHz and 1 MHz tuning steps

(non-Europe version)

Push the selected band's [V/MHz] once or twice to select 10 MHz or 1 MHz tuning step, respectively. Push [V/MHz] once or twice to return to the previous tuning step.

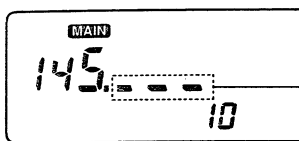

While 1 MHz tuning step is selected, the digits below 100 kHz disappear.

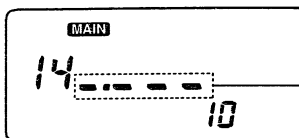

While 10 MHz tuning step is selected, the digits below 1 MHz disappear.

■ Using [UP]/[DN] switches

Push [UP] or [DN] on the microphone to set the main band's frequency according to the selected tuning steps.

- Be sure the up/down switch on the microphone is activated.
- Pushing [UP] or [DN] for more than 0.5 sec. will activate a scan.
- If a scan is started, push [UP] or [DN] again to stop it.



[UP/DN] position

NOTE:

[UP] and [DN] cannot be used for frequency setting while:

- [UP]/[DN] switch remote is in use. (p. 34)
- In remote standby condition. (p. 40)
- Mic DTMF remote or external DTMF remote is in use. (pgs. 40, 41)

3 FREQUENCY SETTING

■ Frequency lock function

To prevent accidental frequency changes and unnecessary function access, use the lock function. This function locks the tuning dials and switches electronically.

Push and hold [SET•LOCK] until "L" appears in the memory channel readout to activate the function.

- To cancel the function, push and hold [SET•LOCK] until "L" disappears.

- [PTT], [MONI] (pushing [VOL]) and band selection (pushing the tuning dial) can be used while the lock function is in use. DTMF tone can be transmitted from the HM-95.*

* Optional for non-U.S.A. versions.

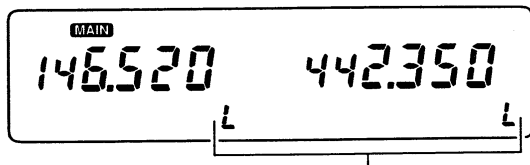

2 "L" 's appear while the frequency lock function is in use.

■ Tuning step selection SET mode

Tuning steps are the minimum frequency change increments when you rotate the tuning dial or push the [UP]/[DN] keys on the microphone. Separate tuning steps can be specified for both bands. The following tuning steps are available.

- 5 kHz
- 10 kHz
- 12.5 kHz
- 15 kHz
- 20 kHz
- 25 kHz
- 30 kHz
- 50 kHz

/// **NOTE:** For your convenience, select a tuning step that matches the frequency intervals of repeaters in your area.

- ① Push the desired band's tuning dial to assign the main band.
- ② Push the selected band's [V/MHz] to select VFO mode if another mode has been selected.
- ③ Push [SET] one or more times until "tS" appears as shown below.
 - Pushing [S.MW] reverses the selection order. (p. 48)
 - Cancel pager or code squelch in advance. (pgs. 37, 38)

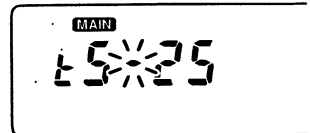

25 kHz tuning step

- ④ Rotate the selected band's tuning dial to select the tuning step.
- ⑤ Push the selected band's tuning dial to exit set mode.

Receiving

The IC-2350H can receive VHF and UHF band signals simultaneously. Perform steps ②–④ for each band.

- ① Push [POWER] for 2 sec. to turn the power ON.
- ② Set the desired band's squelch and audio levels.
 - Rotate [SQL] counterclockwise to open the squelch.
 - Rotate [VOL] to adjust the audio output level.
 - Rotate [SQL] clockwise until noise is just muted.
- ③ Select VFO mode with the desired band's [V/MHz].
- ④ Set the selected band's operating frequency. (p. 12)

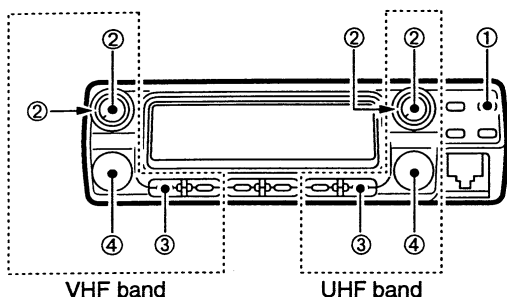

◇ When a signal is received

- The squelch opens and the speaker emits audio.
- "BUSY" appears.
- The S/RF indicator shows the relative signal strength.

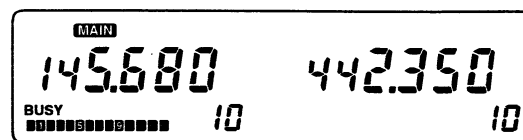

When receiving a signal on VHF.

◇ Monitor function

This function is used to listen to weak signals without disturbing the squelch level setting.

Push and hold the desired band's [VOL] to open the desired band's squelch.

◇ RF attenuator

The transceiver has an RF attenuator related to the [SQL] setting. The attenuator is automatically activated when [SQL] is rotated further than the 12 o'clock position. Approx. 10 dB attenuation is obtained at full rotation.

- Further rotation may prevent reception of weak signals. Use the monitor function before transmitting.

◇ Mute function

(optional UT-101 and a DTMF microphone is required.)

This function mutes both bands' audio signals quickly without disturbing the volume settings. (p. 42)

4 BASIC OPERATION

■ Transmitting

CAUTION: Transmitting without an antenna may damage the transceiver.

NOTE:

- To prevent interference, listen on the frequency before transmitting by pushing the main band's [VOL].
- To prevent howling and sensitivity reduction, **AVOID** setting the UHF band frequency near 3 times the VHF band frequency; e.g. setting for 145 MHz and 435 MHz.



- ① Push the desired band's tuning dial to assign the main band for transmitting.
- ② Set the operating frequency. (p. 12)
- ③ If "DUP" or "DUP-" appears, push [DUP] once or twice until "DUP" or "DUP-" disappears to select simplex.
- ④ Push and hold [PTT] to transmit.
 - "  " appears and the S/RF indicator shows the output power selection.
- ⑤ Speak into the microphone using your normal voice level.
 - **DO NOT** hold the transceiver too close to your mouth or speak too loudly. This may distort the signal.
- ⑥ Release [PTT] to return to receive.

◇ Output power selection

The transceiver has 3 output power levels to suit your operating requirements.

- ① Push the desired band's tuning dial to assign the main band.
- ② Push [LOW] one or more times to select the main band's output power.
 - The output power can be changed while transmitting.

◇ Selectable output power levels

Power selection	Low power indicator	S/RF indicator while transmitting	Output power	
			VHF	UHF
High	Disappears		50 W	35 W
Low 2 (LPo-2)	Appears		10 W	10 W
Low 1 (LPo-1)	Appears		5 W	5 W

◇ What are simplex and duplex?

Simplex	Used for normal communication. Simplex means transmitting and receiving on the same frequency.
Duplex	Used for communication via a repeater. Duplex means transmitting and receiving on different frequencies. (p. 16)

■ Accessing

A repeater receives signals and re-transmits them on a different frequency. Thus, longer communication distances are available. To access a repeater that requires a tone, refer to right.

- ① Push the desired band's tuning dial to assign the main band.
- ② Select VFO mode with the selected band's [V/MHz].
- ③ Set an offset frequency matched with the repeater, if required. (p. 17)
- ④ Set the repeater output frequency as your receive frequency.
- ⑤ Push [DUP] once or twice to select either "DUP" or "DUP -" offset direction.

Transmitting frequency shifts in lower direction

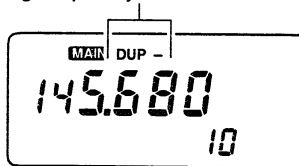

- ⑥ Push [PTT] to access the repeater.

◇ Monitor function during repeater operation

While pushing the main band's [VOL], the transceiver receives the repeater input frequency.

◇ Subaudible tone ON/OFF

The transceiver includes a subaudible tone encoder which has 50 kinds of tone frequencies. For setting the tone frequency, see the next page for details.

- ① Select a subaudible tone frequency. (p. 17)
- ② Push [DUP•TONE] for 2 sec.
- "T" appears.
- ③ To cancel, push [DUP•TONE] for 2 sec.
- When an optional UT-89 TONE SQUELCH UNIT is installed, push [DUP•TONE] for 2 sec. 3 times.

◇ DTMF code (U.S.A. version)

- For the HM-95, push desired keys on the DTMF keyboard while pushing [PTT].
- For the optional HM-77, push desired keys on the DTMF keyboard.

◇ 1750 Hz tone call (Europe and Italy versions)

- Push and hold [TONE] on the HM-96 HAND MICROPHONE for approx. 1-3 sec.
- To transmit a 1750 Hz tone using the optional HM-77 DTMF MICROPHONE, perform as follows:
 - ① Push [MR].
 - ② Push and hold [#] to transmit a continuous tone or push [*] to transmit a tone for approx. 0.5 sec.
 - ③ Push [MR] to return to microphone normal mode.

5 REPEATER OPERATION

■ Tone frequency

SET mode

Select a subaudible tone frequency that matches a repeater (or another station for optional tone squelch operation).

- ① Push the desired band's tuning dial.
- ② Select VFO mode, a memory channel, etc., if required.
 - A subaudible tone frequency is independently programmable into a VFO or each channel.
- ③ Push [SET] one or more times until "T" blinks.
 - Pushing [S.MW] reverses the order of selection. (p. 48)
 - Cancel pager or code squelch in advance. (pgs. 37, 38)
- ④ Rotate the selected band's tuning dial to set a subaudible tone frequency.
- ⑤ Push either band's tuning dial to exit SET mode.

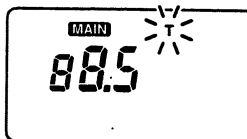

Initial setting

All versions,
VHF/UHF bands:
88.5 Hz

◇ Subaudible tone frequency list (Unit: Hz)

67.0	82.5	100.0	123.0	151.4	171.3	189.9	210.7	250.3
69.3	85.4	103.5	127.3	156.7	173.8	192.8	218.1	254.1
71.9	88.5	107.2	131.8	159.8	177.3	196.6	225.7	
74.4	91.5	110.9	136.5	162.2	179.9	199.5	229.1	
77.0	94.8	114.8	141.3	165.5	183.5	203.5	233.6	
79.7	97.4	118.8	146.2	167.9	186.2	206.5	241.8	

■ Offset frequency

SET mode

The difference between the repeater input and output frequencies is called the offset frequency. Select an offset frequency that matches a repeater for each band.

- ① Push the desired band's tuning dial.
- ② Select VFO mode, a memory channel, etc., if required.
 - An offset frequency is independently programmable into a VFO or each channel.
 - The tuning step of the offset frequency is the same as the tuning step for the selected band.
- ③ Push [SET] one or more times until "DUP" blinks.
 - Pushing [S.MW] reverses the order of selection. (p. 48)
 - Cancel pager or code squelch in advance. (pgs. 37, 38)
- ④ Rotate the selected band's tuning dial to set the offset frequency.
 - To select 1 MHz steps, push the selected band's [V/MHz].



600 kHz (0.6 MHz) offset frequency

Initial setting

Version	VHF	UHF
U.S.A. Asia	600 kHz	5 MHz
Europe Italy		7.6 MHz

- ⑤ Push either band's tuning dial to exit SET mode.

Auto repeater

INITIAL SET mode

U.S.A. version only

The U.S.A. version automatically activates the repeater settings (DUP or DUP- and tone encoder ON/OFF) when the operating frequency falls within the general repeater output frequency range and deactivates them when outside of the range.

- ① Turn the power OFF.
- ② While pushing [SET], turn the power ON to enter INITIAL SET mode.
- ③ Push [SET] one or more times until "rPt" appears.
- ④ Rotate the VHF tuning dial to activate the auto repeater function ("rPt-r1" or "rPt-r2") or cancel ("rPt-oF").
- "rPt-r1" and "rPt-r2" automatically set the duplex setting and duplex/tone encoder settings, respectively.
- ⑤ Push [POWER] for 2 sec. to turn the power OFF to exit INITIAL SET mode.

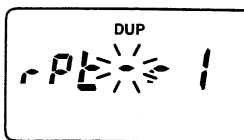

Duplex setting: Automatic
Tone encoder: Manual

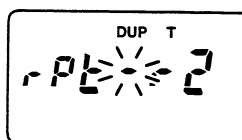

Automatic
Automatic

◇ Frequency range and offset direction

VHF	145.200–145.495 MHz	"DUP –" appears.
	146.610–146.995 MHz	"DUP" appears.
	147.000–147.395 MHz	"DUP" appears.
UHF	442.000–444.995 MHz	"DUP" appears.
	447.000–449.995 MHz	"DUP –" appears.

■ Tone scan

UT-89 is required.

By monitoring a signal that is being transmitted on a repeater input frequency, you can determine the tone frequency necessary to open a repeater.

- ① Select the desired band, then set the desired frequency to be checked for a tone frequency.
- ② Push [DUP•TONE] for 2 sec., one or more times until "T SQL" appears on the function display.
- ③ Push [LOW•SCAN] for 2 sec. to start the tone scan.
- To change the scanning direction, rotate the tuning dial.
- ④ When the tone frequency is matched, the squelch opens and the tone frequency is programmed into the selected mode such as VFO, memory or call channel.
- ⑤ Push the selected band's [V/MHz] to stop the scan.
- ⑥ Push [DUP•TONE] for 2 sec. twice to activate the tone encoder with the detected tone frequency.

6

MEMORY AND CALL CHANNELS

General description

The transceiver has 1 call channel and 50 regular memory channels plus 1 pair of scan edge memory channels on each band; each of these can be individually programmed with the following data. The transceiver has 2 programming procedures: (1) without checking the overwriting channel and (2) after selecting the channel to be programmed.

- Operating frequency (p. 12)
- Duplex direction (DUP or DUP -) (p. 16)
- Offset frequency (p. 17)
- Subaudible tone frequency (p. 17)
- Subaudible tone encoder ON/OFF (p. 16)
- Tone squelch ON/OFF*¹ (p. 39)
- Skip information*² (p. 29)

*¹ An optional UT-89 TONE SQUELCH UNIT is necessary.

*² Except for the call and scan edge memory channels.

Memory channel notes

- Memory channels cannot be erased or masked (undisplayed).
- All memory channels are set as skip channels initially. However, the skip information is erased automatically when a new frequency is programmed.

Memory channel selection

- ① Push the desired band's tuning dial.
- ② Push the selected band's [M/CALL] once or twice to select memory mode.
- "M" appears.
- ③ Select the desired memory channel.

Using the tuning dial:

Rotate the selected band's tuning dial to select the desired memory channel.

Using the [UP]/[DN] switches:

Push [UP] or [DN] to change the memory channel.

- Pushing [UP] or [DN] for more than 0.5 sec. will activate memory scan. If scan starts, push [UP] or [DN] again to stop the scan.

- ④ To return to VFO mode, push the selected band's [V/MHz].

"M" appears to indicate memory mode is selected.

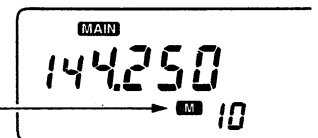

Using the optional Mic DTMF remote function (UT-101 DTMF UNIT is required), the memory channel can be directly selected from a DTMF microphone, e.g. an optional HM-77, HM-95,* etc. See p. 40 for details.

* The HM-95 is supplied with the U.S.A. version.

■ Programming without checking the overwriting channel

The select memory write mode is useful to program without checking the overwriting channel when first applying power or after resetting. The memory or call channel contents to be overwritten cannot be checked in this case.

① Select the desired frequency in VFO mode:

- Push the desired band's tuning dial.
- Push the selected band's [V/MHz] to select VFO mode.
- Set the frequency using the selected band's tuning dial.
- Set other data (e.g. offset frequency, duplex direction, sub-audible tone encoder ON/OFF and its frequency), if required.

② Push [S.MW] to enter select memory write mode.

- The memory channel readout starts flashing.

③ Rotate the selected band's tuning dial to select the memory or call channel ("C") to be programmed.

④ Push [S.MW•MW] again for 1 sec. to program.

- 3 beeps may sound and the VFO contents (including the sub-audible tone frequency, etc.) are programmed.
- Memory channel number advances when continuously pushing [S.MW•MW] for 1 sec. after programming. (p. 23)

⑤ Repeat ①–④ to program another channel.

- Repeat ① and ④ when next memory channel is selected at ④.

[EXAMPLE]: Programming 145.875 MHz into memory channel 20.

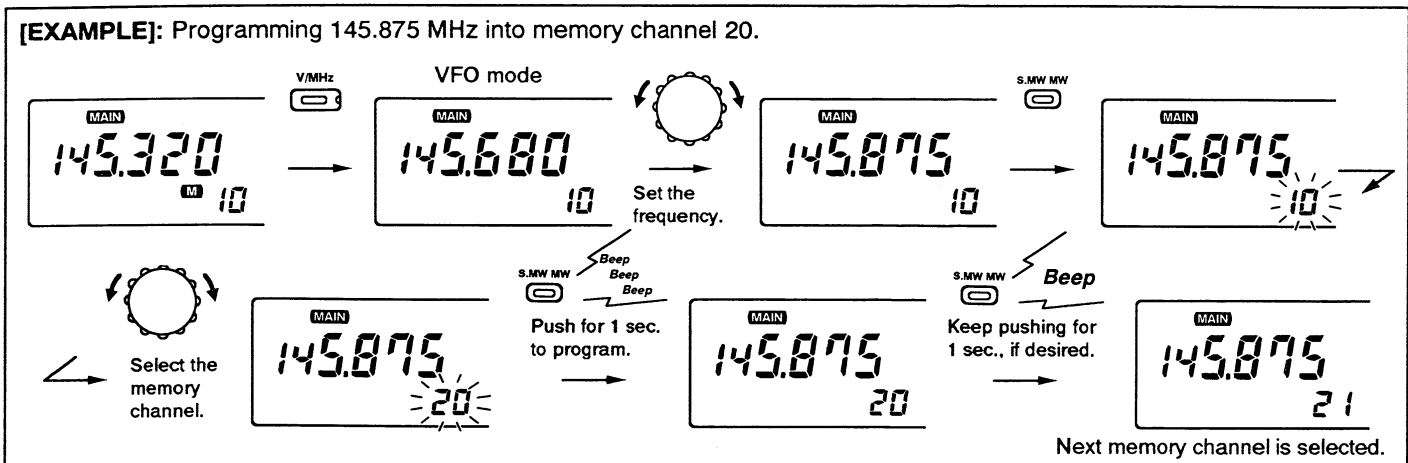

6 MEMORY AND CALL CHANNELS

■ Programming after selecting a memory or call channel

To program the memory or call channel after checking the selected memory or call channel contents to be overwritten, perform as follows.

- ① Select the memory or call channel to be programmed:
 - Push the desired band's tuning dial.
 - Select memory mode or call channel by pushing the selected band's [M/CALL] once or twice. ("M" or "C" appears.)
 - For the memory channel, rotate the selected band's tuning dial to select the memory channel.
- ② Set the desired frequency in VFO mode:
 - Push the selected band's [V/MHz] to select VFO mode.
 - Set the frequency using the selected band's tuning dial.
 - Set other data (e.g. offset frequency, duplex direction, subaudible tone encoder ON/OFF and its frequency), if required.
- ③ Push [S.MW•MW] for 1 sec. to program.
 - 3 beeps may sound and the VFO contents (including the subaudible tone frequency, etc.) are programmed.
 - Memory channel number advances when continuously pushing [S.MW•MW] for 1 sec. after programming. (p. 23)

■ Transferring memory contents into the VFO

This function transfers a memory, scratch pad memory (p. 24) or call channel's contents into the VFO. This is useful when searching for signals around a memory or call channel's frequency and for recalling the offset frequency, subaudible tone frequency, etc.

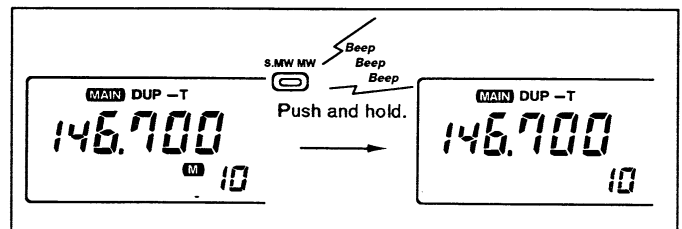

- ① Select the memory or call channel to be transferred:
 - Push the desired band's tuning dial.
 - Select memory mode or call channel by pushing the selected band's [M/CALL] once or twice. ("M" or "C" appears.)
 - For the memory channel, rotate the selected band's tuning dial to select the memory channel.
- ② Push [S.MW•MW] for 1 sec. to transfer.
 - "M" disappears or "C" changes to "c" as VFO mode is automatically selected.
 - 3 beeps may sound and the memory contents (including the subaudible tone frequency, etc.) are transferred.

■ Transferring memory or call channel contents

This function transfers a memory or call channel's contents into another memory, call or scan edge channel; or makes a copy of memory information. This is useful for editing or copying the memory contents.

① Select the memory or call channel to be transferred:

- Push the desired band's tuning dial.
- Select memory mode or call channel by pushing the selected band's [M/CALL] once or twice. ("M" or "C" appears.)
- For the memory channel, rotate the selected band's tuning dial to select the memory channel.

② Push [S.MW] to enter select memory write mode.

- The memory channel readout changes to "--" and starts flashing.

③ Rotate the selected band's tuning dial to select the memory channel number to be transferred.

- "--" indicates VFO mode.

④ Push [S.MW·MW] again for 2 sec. to transfer.

- 3 beeps may sound and the memory contents (including the subaudible tone frequency, etc.) are transferred and programmed.
- When "--" is displayed, the contents are transferred to VFO.
- When "C" is displayed, the contents are transferred and programmed to the call channel.

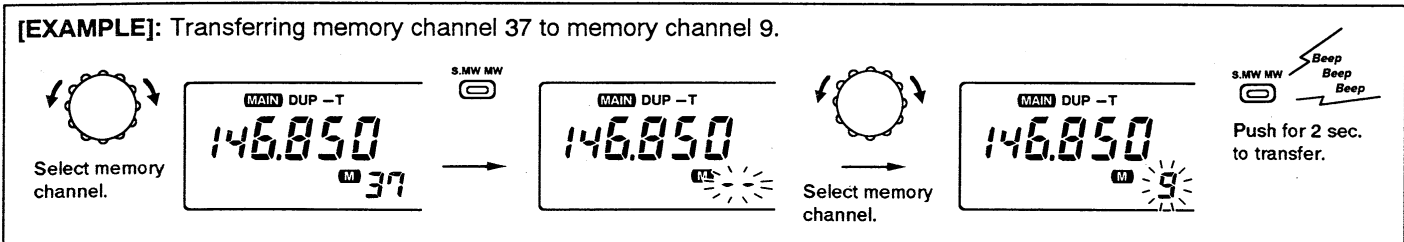

6 MEMORY AND CALL CHANNELS

■ Auto channel advance

The selected memory channel number in VFO mode automatically advances when programming a memory channel. This is useful when programming 2 or more memory channels at once.

Push [S.MW·MW] for 2 sec. to program the VFO contents into the selected memory channel and advance the memory channel number.

- 3 beeps and a longer beep may sound.
- When you do not want to advance the memory channel number, release [S.MW·MW] after 3 beeps sound. (Memory channel programming is completed in approx. 1 sec.)

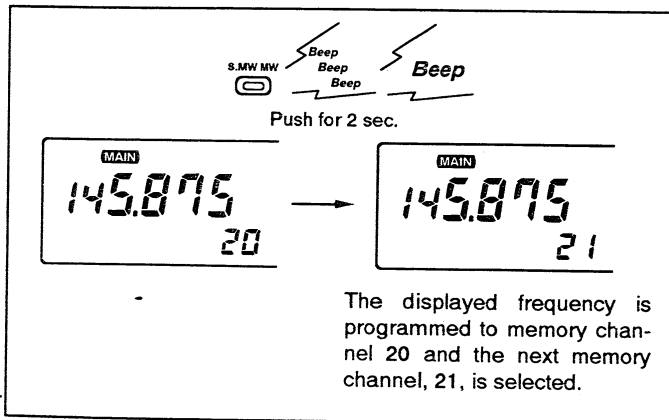

■ Calling up a call channel

The transceiver has a call channel on each band for quick access to a most-often-used frequency.

- ① Push the desired band's tuning dial.
- ② Push the selected band's [M/CALL] once or twice to select the call channel.
 - A large "C" appears.
- ③ To return to VFO or memory mode, push the selected band's [V/MHz] or [M/CALL], respectively.
 - The large "C" changes to a small "c" when VFO mode is selected.

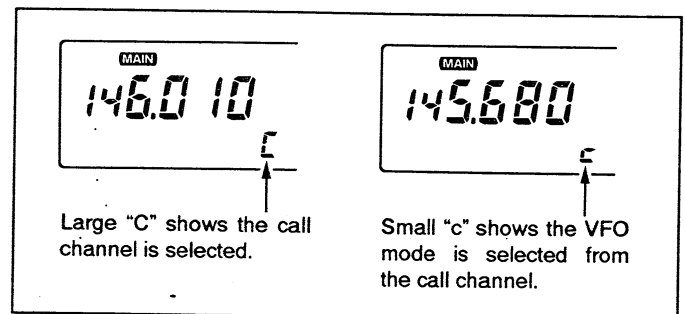



■ What is a scratch pad memory

The transceiver automatically memorizes operating frequency information, separate from regular memory channels, when transmitting.

When transmitting in simplex (normal communication use), the operating frequency is stored into a simplex scratch pad memory. When transmitting with a duplex setting (for repeater use), the operating frequency is stored into a duplex scratch pad memory.

Each band has 1 simplex and 1 duplex scratch pad memory.

◇ Transferring a scratch pad memory

Transferring scratch pad memories can be done in a similar manner to transferring regular memory or call channel contents as described on p. 21.

Transferring in select memory write mode is not available.

■ Calling up a scratch pad memory

- ① Push the desired band's tuning dial.
- ② Push the selected band's [M/CALL] once or twice to select the call channel.
 - A large "C" appears.
- ③ Rotate the tuning dial clockwise or push [UP] to select a duplex scratch pad memory; rotate the tuning dial counterclockwise or push [DN] to select a simplex scratch pad memory.
 - Previously transmitted frequency and "L1" or "r1" appears.
 - When first applying power or after CPU resetting, scratch pad memories contain no data and therefore cannot be accessed.
- ④ Push the selected band's [V/MHZ] to return to VFO mode or push the selected band's [M/CALL] to select memory mode.

/// The previous simplex or duplex scratch pad memory will be cleared (overwritten) when transmitting on a new frequency or with new repeater settings, etc.

8

SCAN OPERATION

Scan types

Scanning searches for transmitted signals automatically and makes it easier to locate new stations for contact or listening purposes.

Each band has 3 scan types and 5 resume conditions to suit your needs.

FULL SCAN (p. 26)

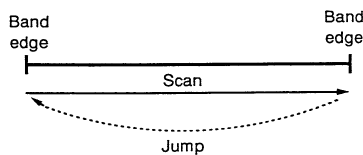

Repeatedly scans all frequencies over the entire selected band. Used as a simple default scan.

PROGRAMMED SCAN (p. 26)

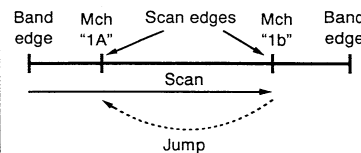

Repeatedly scans between two user-programmed frequencies. Used for checking for frequencies within a specified range such as repeater output frequencies, etc.

MEMORY SCAN (p. 28)

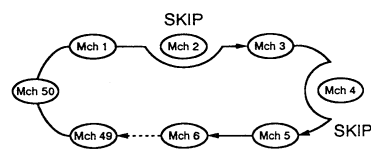

Repeatedly scans memory channels within the range of the set memory area except skip channels. Used for checking often-called channels and bypassing normally busy channels such as repeater frequencies.

SCAN RESUME CONDITION (p. 30)

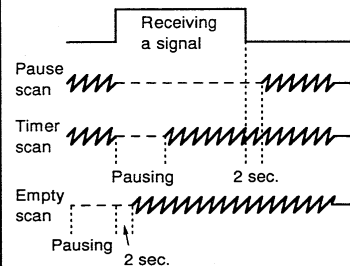

5 resume conditions are available.

- Pause scan: When receiving a signal, pauses until the signal disappears.
- 3 timer scans: When receiving a signal, pauses for 5, 10 or 15 sec.
- Empty scan: Pauses until a signal appears.

■ Full scan and programmed scan

The procedure for full scan and programmed scan is the same. Previously used scan or a scan preset in set mode is activated.

- ① Push the desired band's tuning dial.
- ② Select VFO mode with the selected band's [V/MHz] switch.
- ③ Set the selected band's [SQL] to the point where noise is muted.
- ④ Push [UP]/[DN] on the microphone for 2 sec. or [LOW•SCAN] for 2 sec. to start the scan.
 - When the optional tone squelch is in use, [LOW•SCAN] starts the tone scan. (p. 18) Use [UP]/[DN] in this case.
 - To change the scanning direction, rotate the scanning band's tuning dial.
 - Memory channel readout shows the selected scan types as follows:
 - "AL" : Full scan is selected.
 - "P1" : Programmed scan is selected.
- ⑤ Push [SET] to alternate between full scan and programmed scan, if desired.
- ⑥ To stop the scan, push [UP]/[DN] or [LOW•SCAN].

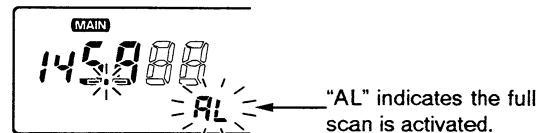
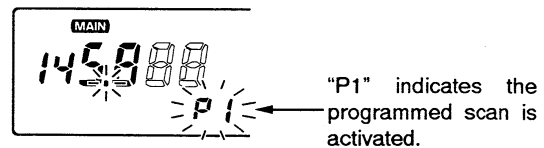

◇ Scan resume condition:

- When receiving a signal, scan resumes in one of the following ways:
 - after pausing 15 sec.
 - after pausing 10 sec.
 - after pausing 5 sec.
 - after the signal disappears or appears.
- The scan resume condition can be selected in set mode. (p. 30)
- While scanning, rotating the tuning dial changes the scanning direction or skips a paused frequency.

8 SCAN OPERATION

■ Programming scan edges

Scan edges can be programmed in the same way as memory channels. (pgs. 20, 21) Memory channels "1A" and "1b" are available for programming scan edges.

- ① Push the desired band's tuning dial.
- ② Select scan edge memory channel "1A":
 - Select memory mode by pushing the selected band's [M/CALL] once or twice.
 - Rotate the selected band's tuning dial to select memory channel "1A."

- ③ Push the selected band's [V/MHz] to select VFO mode.
- ④ Rotate the selected band's tuning dial to set the desired frequency.
- ⑤ Push [S.MW•MW] for 2 sec. to program and advance the memory channel number.
 - 3 beeps and a longer beep may sound, the VFO contents are programmed and the other scan edge memory channel, "1b," is selected.
- ⑥ To program a frequency for the other scan edge memory channel, "1b," repeat steps ④, ⑤.
 - If the same frequency is programmed into the scan edges, programmed scan will not function.

[EXAMPLE]: Programming 145.30 MHz and 145.80 MHz for the VHF scan edges, "1A" and "1b."

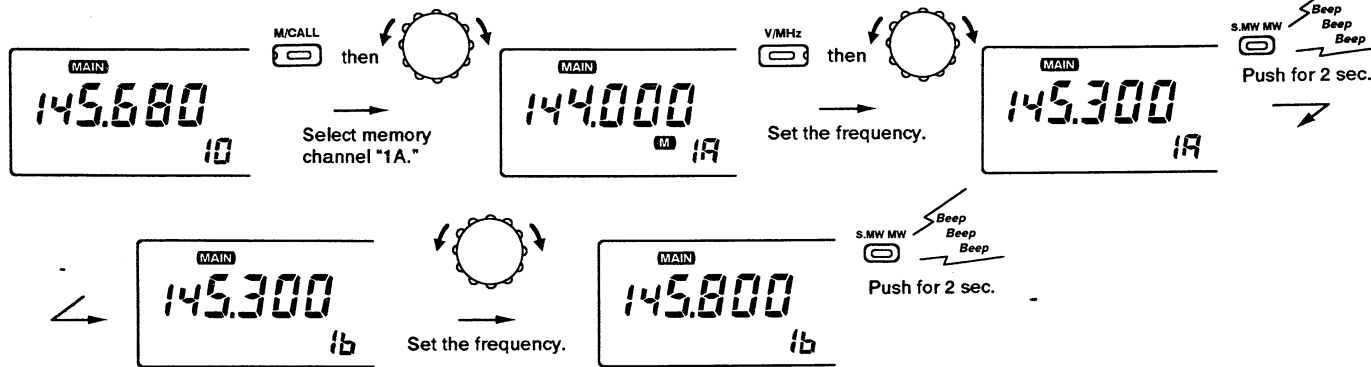

Memory channel "1b" is selected in VFO mode.

■ Scan type selection SET mode

Each band has a pair of scan edges. They are programmable and are used for scanning within a range such as repeater output frequencies, regulated simplex frequencies, etc. The other scan edges are the band edges for full scan and cannot be changed.

Pushing [SET] during scan selects full or programmed scan alternately and also changes this set mode setting.

- ① Push the desired band's tuning dial.
- ② Push [SET] one or more times until "PSC" appears as shown below.
 - Pushing [S.MW] reverses the order of selection. (p. 48)
 - Cancel pager or code squelch in advance. (pgs. 37, 38)

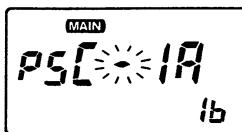

Programmed scan is selected for the VHF band.

- ③ Rotate the selected band's tuning dial to select full scan or programmed scan.
 - "PSC-AL" : Scan operates as full scan.
 - "PSC-1A 1b" : Scan operates as programmed scan.
- ④ Push the tuning dial to exit set mode.

■ Memory scan

Memory scan repeatedly scans memory channels except skip channels (p. 29).

- ① Push the desired band's tuning dial.
- ② Select memory mode by pushing the selected band's [M/CALL] once or twice.
- ③ Set [SQL] to the point where noise is muted.
- ④ Push [UP]/[DN] on the microphone for 2 sec. or [LOW•SCAN] for 2 sec. to start the scan.
 - When the optional tone squelch is in use, [LOW•SCAN] starts the tone scan. (p. 18)
 - To change the scanning direction, rotate the scanning band's tuning dial.
 - The scan resume condition is the same as for programmed scan. See pgs. 26, 30 for details.
- ⑤ To stop the scan, push [UP]/[DN] or [LOW•SCAN].

NOTE: All memory channels are set as skip channels by default. Program more than two memory channels (pgs. 20, 21) or cancel the skip function for more than two memory channels (p. 29) in advance.

8 SCAN OPERATION

■ Skip channel setting SET mode

The memory skip function speeds up the scan interval, checking only desired memory channels. When first applying power or after resetting the CPU, all memory channels are specified as skip channels. Programming a memory channel automatically cancels its skip setting. Set memory channels to be skipped or scanned as follows.

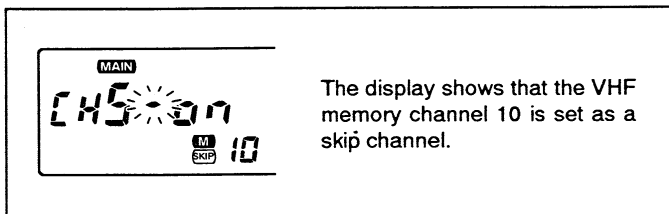

- ① Push the desired band's tuning dial.
- ② Select the desired memory channel:
 - Select memory mode by pushing the selected band's [M/CALL] once or twice.
 - Rotate the selected band's tuning dial to select the memory channel.
- ③ Push [SET] one or more times until "CHS" appears as shown above.
 - Pushing [S.MW] reverses the order of selection. (p. 48)
 - Cancel pager or code squelch in advance. (pgs. 37, 38)

- ④ Rotate the selected band's tuning dial to turn the skip function ON or OFF on the selected channel.
 - "~~SKIP~~" appears : The memory channel is skipped during (CHS-on) memory scan.
 - "~~SKIP~~" disappears: The memory channel is scanned during (CHS-oF) memory scan.
- ⑤ Push the tuning dial to exit set mode.

NOTE: The scan edge memory channels (1A, 1b) cannot be specified as skip channels, however, they are skipped during memory scan, regardless.

■ Scan resume condition

SET mode

The resume condition can be selected as a pause, empty or timer scan. Empty scan is useful for finding unused frequencies. The selected resume condition is valid for priority watch as well. (p. 32)

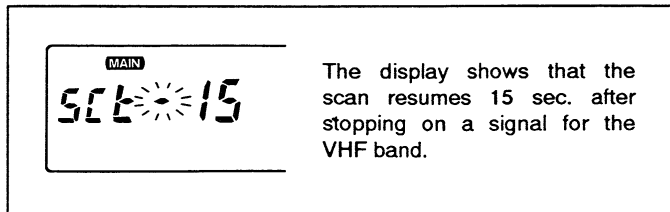

- ① Select the desired band's tuning dial.
- ② Push [SET] one or more times until "SCT" or "SCP" appears as shown above.
 - Pushing [S.MW] reverses the order of selection. (p. 48)
 - Cancel pager or code squelch in advance. (pgs. 37, 38)

- ③ Rotate the selected band's tuning dial to set the desired timer.
 - "Sct- 5" : Scan pauses 5 sec. while receiving a signal.
 - "Sct-10" : Scan pauses 10 sec. while receiving a signal.
 - "Sct-15" : Scan pauses 15 sec. while receiving a signal.
 - "SCP- 2" : Scan pauses on a signal until it disappears and then resumes 2 sec. thereafter.
 - "Sct-EP" : Scan pauses on a frequency that is not busy and resumes 2 sec. after a signal appears.
- ④ Push the tuning dial to exit set mode.

9

PRIORITY WATCH

Priority watch types

The priority watch checks for signals on a memory or call channel every 5 sec. while operating on a VFO frequency. The transceiver has 3 priority watch types to suit your needs. You can transmit on the VFO frequency while the priority watch operates.

The watch resumes according to the selected scan resume condition. See the previous page for settings.

NOTE:

- The priority watch cannot be started from a scratch pad memory.
- The optional pager and code squelch are turned OFF when priority watch starts.
- If the optional pocket beep function is activated, the transceiver automatically selects the tone squelch function when priority watch starts.
- When "SCt-EP" is selected for the scan resume condition, the priority watch pauses on a no-signal channel. (p. 30)

MEMORY CHANNEL WATCH (p. 32)

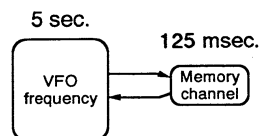

While operating on a VFO frequency, priority watch checks for a signal on the selected memory channel every 5 sec.
- A memory channel with skip information can be watched.

CALL CHANNEL WATCH (p. 32)

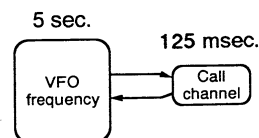

While operating on a VFO frequency, priority watch checks for a signal on the call channel every 5 sec.

MEMORY SCAN WATCH (p. 32)

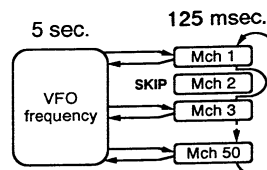

While operating on a VFO frequency, priority watch checks for signals on each memory channel in sequence.
- The memory skip function is useful to speedup the scan.

Priority watch operation

◆ Watching a memory or call channel

- ① Push the desired band's tuning dial.
- ② Select VFO mode; then, set an operating frequency.
- ③ Push the selected band's [M/CALL] once or twice to select a memory channel or call channel.
 - "M" or "C" appear.
- ④ Push [DTMF•PRIO] for 2 sec. to start the priority watch.
 - The transceiver checks a memory or call channel frequency every 5 sec.
 - The watch resumes according to the selected scan resume condition. (p. 30)
 - While the watch is pausing, pushing the watching band's [V/MHz] resumes the watch manually.
- ⑤ The VFO and the other band can be used for normal operation.
 - When a signal is received on the watching frequency, the VFO communication will be interrupted.
- ⑥ Push the watching band's [M/CALL] while the display shows the VFO frequency to stop the watch.

◆ Watching memory channels

- ① Push the desired band's tuning dial.
- ② Select VFO mode; then, set an operating frequency.
- ③ Push the selected band's [M/CALL] once or twice to select memory mode.
 - "M" appears.
- ④ Push [LOW•SCAN] for 2 sec. or [UP]/[DN] on the microphone for 2 sec. to start the memory scan.
- ⑤ Push [DTMF•PRIO] for 2 sec. to start the priority watch.
 - The transceiver checks memory channel frequencies every 5 sec., in sequence.
 - The watch resumes according to the selected scan resume condition. (p. 30)
 - While the watch is pausing, pushing the watching band's [V/MHz] resumes the watch manually.
- ⑥ The VFO and the other band can be used for normal operation.
 - When a signal is received on the watching frequency, the VFO communication will be interrupted.
- ⑦ Push the watching band's [M/CALL] while the display shows the VFO frequency to stop the watch.

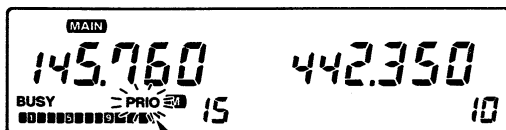

While pausing on the watching channel or frequency, "PRIO" flashes.

10 SUB BAND FUNCTIONS

Sub band access

This function allows you to access most of the sub band's functions and settings while retaining the main band as a transmitting band.

- Push and hold the sub band's tuning dial until "SUB" appears to access the sub band.

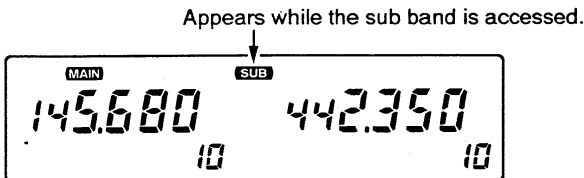

- Push the desired switch to control the sub band.
- Cancel sub band access in one of the following ways:
 - Push the main band's tuning dial.
 - Push and hold the sub band's tuning dial.
 - To select the current sub band as the new main band, push the sub band's tuning dial.
 - "SUB" disappears.

NOTE: Even while the sub band is accessed:

- Optional pager and code squelch functions operate for the main band.
- The main band still functions for receiving and transmitting.

Sub band mute/ sub band busy beep

SET mode

These functions perform the following:

SUB band mute	Automatically mutes sub band's audio signals when the main and sub bands' signals are simultaneously received.
SUB band busy beep	A beep tone sounds to inform you when the sub band's squelch closes. This beep tone means that a signal is received on the sub band.

- Push [SET] or [S.MW] one or more times until "Sub" appears.

- Cancel pager or code squelch in advance. (pgs. 37, 38)

- Rotate the selected band's tuning dial to set the condition.

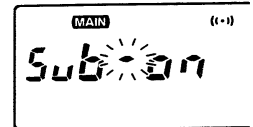

The display shows that both the sub band mute and sub band busy beep are turned ON.

Indication	SUB band mute	SUB band busy beep
"Sub-oF"	Cancelled	Cancelled
"Sub-oF (••)"	Cancelled	Activated
"Sub-on"	Activated	Cancelled
"Sub-on (••)"	Activated	Activated

- Push the tuning dial to exit SET mode.

Assigning a function to the [UP] or [DN] switch

The [UP] and [DN] switches on the microphone can be programmed to control one of the switches on the front panel. By using this function, you can easily and quickly access an often-used switch without stretching to reach the transceiver front panel.

- ① Push [POWER] for 2 sec. to turn power OFF.
- ② Be sure that the [UP/DN OFF] switch on the microphone is set to the UP/DN position (i.e. the lock function is not activated.).
- ③ While pushing [UP] or [DN] on the microphone and the desired switch on the front panel, turn power ON.
 - The [UP] or [DN] switch functions as the desired switch, including its secondary function (when pushing [UP] or [DN] for 2 sec.).
- ④ To cancel this function, turn power OFF; then, while pushing the desired switch, [UP] or [DN], turn power ON.

▨ The programmed [UP] switch function cannot be activated when DTMF remote is in standby. (pgs. 40–43)

▨ When assigning the tuning dial switch, push the switch to toggle the main and sub band; push and hold the switch to turn the sub band access function ON.

[EXAMPLE]

The following example shows how to program [DN] on the microphone to function as [LOW-SCAN].

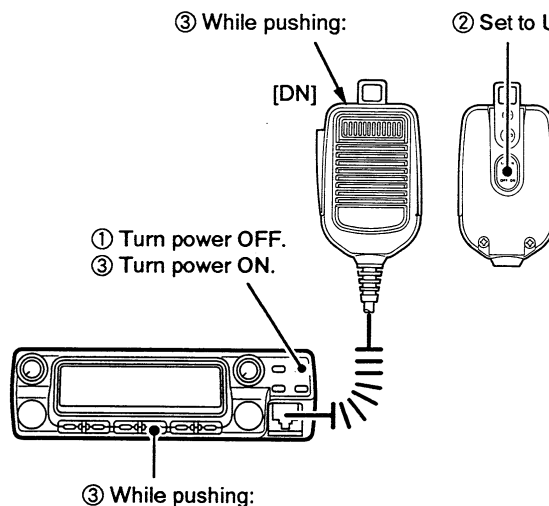

- ① Push [POWER] for 2 sec. to turn power OFF.
- ② Set the [UP/DN OFF] switch to UP/DN.
- ③ While pushing [DN] and [LOW-SCAN], turn power ON.
 - The [DN] switch functions as the [LOW-SCAN] switch.
 - The [UP] switch function is not changed.

12 PAGER AND CODE SQUELCH

UT-101 is required.

General description

◇ Pager function

This function uses DTMF codes for paging and can be used as a "message pager" to inform you of a caller's identity even if you leave the transceiver temporarily unattended.

Personal calls and group calls are available with the pager function. Personal calls use the receiving parties' ID code for calling. The receiving parties' display shows your ID code and other stations in the party know that you called. You can also call all stations in your group using the group call.

To use the pager function in your group, all stations need the pager function.

◇ Code squelch

Code squelch operation provides communication with silent standby since you will only receive calls from stations which know your ID or group code.

The code squelch function transmits a 3-digit code prior to voice transmission in order to open the receiving station's code squelch.

PAGER SIMULATION: Personal call

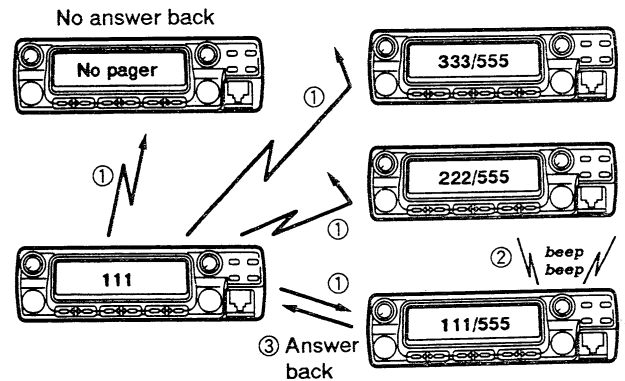

CODE SQUELCH SIMULATION: ID code

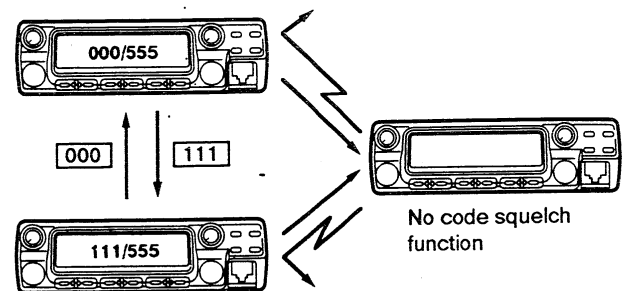

Code programming

◇ Before programming

The pager and code squelch functions require ID codes and a group code. These codes are 3-digit DTMF codes and must be written in the code channels before operation.

◇ Code channel assignment

ID OR GROUP CODE	CODE CHANNEL NUMBER	"RECEIVE ACCEPT" OR "RECEIVE INHIBIT"
Your ID code	0	"Receive accept" only.
Other individual's ID codes	1-5	"Receive inhibit" should be programmed in each channel.
Group code	One of 1-5	"Receive accept" must be programmed.
Memory space*	P	"Receive inhibit" only.

* Code channel P automatically memorizes an ID code when receiving a pager call. The contents in channel P cannot be changed manually.

RECEIVE ACCEPT AND INHIBIT

Code channels 1-5 can store the transmit codes for personal calls with other individuals and the group codes for group calls.

The group codes should be programmed as "receive accept" to receive all calls from your group's members.

◇ Programming

- ① Push the desired band's tuning dial.
- ② Push [DTMF] to turn the pager function ON.
- "P" appears in place of the 100 MHz digit.
- ③ Push [SET] to select the code channel setting display.
- Code channel number flashes.
- ④ Rotate the selected band's tuning dial to select the desired code channel, 0-5.
- Code channel P cannot be used for programming.
- ⑤ Push [SET] or [S.MW] to select the digit to be programmed.
- ⑥ Rotate the selected band's tuning dial to set the digit.
- ⑦ Repeat ⑤ and ⑥ until the last digit is programmed.
- ⑧ Push [DTMF] to set the code channel for "receive inhibit" or "receive accept."
- When "receive inhibit" is set, "**SKIP**" appears.
- Code channel 0 cannot be set as "receive inhibit."
- ⑨ Push the tuning dial to exit the setting display.

If transmit codes are not programmed as "receive inhibit," the transceiver accepts calls directed to other individuals and your answer back in this case may cause confusion – this is not a selective calling system. Therefore, transmit codes should be programmed as "receive inhibit" so the transceiver rejects calls directed to other individuals.

12 PAGER AND CODE SQUELCH

■ Pager operation

◇ Calling a specific station

- ① Push the desired band's tuning dial.
- ② Set the operating frequency for your pager call.
- ③ Push [DTMF] to turn the pager function ON.
 - "P" appears in place of the 100 MHz digit.
 - An optional tone squelch can be used together with the pager function. (p. 39)
- ④ Select the desired code channel:
 - Push [SET].
 - The code channel number flashes. If not, push [SET] or [S.MW] several times.
 - Rotate the selected band's tuning dial to select the code channel.
 - Push tuning dial to exit the setting display.
- ⑤ Push [PTT] to transmit the pager code.
- ⑥ Wait for an answer back.
 - When the transceiver receives an answer back code, the function display shows the other individual's ID or group code and beeps. (p. 38)
- ⑦ After confirming a connection, push the tuning dial to display the operating frequency.
- ⑧ Push [DTMF] once to select code squelch or 3 times to select the non-selective calling system.
 - Rotating the tuning dial also cancels the pager function.
 - Be sure that "REMO" is not displayed when the non-selective calling system is selected.

◇ Waiting for a call from a specific station

- ① Push the desired band's tuning dial.
- ② Set a frequency to wait for a pager call.
- ③ Push [DTMF] to turn the pager function ON.
 - "P" appears in place of the 100 MHz digit.
 - An optional tone squelch can be used together with the pager function. (p. 39)
- ④ Wait for a call.
 - When receiving a call, the other individual's ID or group code appears; "(••)" and the channel number flash as shown on the next page.
- ⑤ Push [PTT] to send an answer back and display the operating frequency.
- ⑥ Push [DTMF] once to select code squelch or 3 times to select the non-selective calling system.
 - Rotating the tuning dial also cancels the pager function.
 - Be sure that "REMO" is not displayed when the non-selective calling system is selected.

/// **NOTE:** Selecting the frequency or changing operating mode cancels the pager or code squelch functions.

PERSONAL CALLS

This display appears when you are called with your ID code and the calling station's ID code is 263.

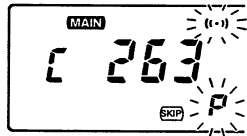

GROUP CALLS

This display appears when you are called with the group code, 123, and 123 has been programmed into code channel 5.

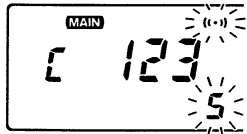

ERROR INFORMATION

When the transceiver receives an incomplete signal, "E" appears.

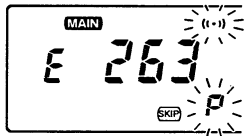

Code squelch operation

- ① Push the desired band's tuning dial.
- ② Set a frequency for code squelch operation.
- ③ Push [DTMF] twice to turn the code squelch ON.
 - "C" appears in place of the 100 MHz digit as shown below.
 - An optional tone squelch can be used together with the code squelch. (p. 39)

"C" appears in place of the 100 MHz digit.

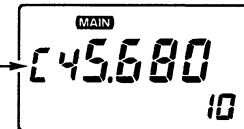

- ④ Select the desired code channel:
 - Push [SET].
 - The code channel number flashes. If not, push [SET] or [S.MW] several times.
 - Rotate the selected band's tuning dial to select the code channel.
 - Push the tuning dial to exit the setting display.
- ⑤ Operate the transceiver in the normal way (push [PTT] to transmit; release [PTT] to receive).
 - Prior to voice transmission, a 3-digit transmit code is sent each time [PTT] is pushed in order to open the receiving station's code squelch.
- ⑥ To cancel the code squelch, push [DTMF] twice.
 - The display shows the operating frequency and "REMO" does not appear.

13 POCKET BEEP AND TONE SQUELCH

UT-89 is required.

■ Pocket beep operation

To operate the pocket beep function, an optional UT-89 is necessary. See p. 10 for installation.

◇ Waiting for a call from a specific station

- ① Push the desired band's tuning dial.
- ② Set a frequency to wait for a call.
- ③ Set the subaudible tone frequency in set mode.
- See p. 17 for setting details.
- ④ Push [DUP•TONE] for 2 sec., several times until "T SQL (••)" appears on the function display.
- Turn OFF the optional pager or code squelch to activate the pocket beep. (pgs. 37, 38) The pocket beep cannot be used in combination with the pager or code squelch.
- ⑤ When a signal with the correct tone is received, the transceiver emits beep tones for 30 sec. and "(••)" flashes.
- ⑥ Push [PTT] to answer or push the tuning dial to stop the beeps.
- Tone squelch is automatically selected.
- ⑦ Push [DUP•TONE] for 2 sec. to cancel the function.

◇ Calling a waiting station using pocket beep

A subaudible tone matched with the station's tone frequency is necessary. Use the tone squelch at right or a subaudible tone encoder (p. 17).

■ Tone squelch operation

The tone squelch opens only when receiving a signal with the same pre-programmed subaudible tone. You can silently wait for a call from group members using the same tone. This function can be activated on both bands with separate tone frequencies simultaneously.

- ① Push the desired band's tuning dial.
- ② Set the operating frequency.
- ③ Set the subaudible tone frequency in set mode.
- See p. 17 for setting details.
- ④ Push [DUP•TONE] for 2 sec., several times until "T SQL" appears in the function display.
- The optional code squelch can be used together with the tone squelch. (p. 38)
- ⑤ When the received signal includes the correct tone, the squelch opens and the signal can be heard.
- When the received signal includes an incorrect tone or no tone, the squelch does not open, however, the S/Rf indicator indicates the signal strength.
- To open the squelch manually, push and hold the desired band's [VOL].
- ⑥ Operate the transceiver in the normal way (push [PTT] to transmit; release [PTT] to receive).
- ⑦ To cancel the tone squelch, push [DUP•TONE] for 2 sec.
- "T SQL" disappears from the function display.

■ General description

The IC-2350H can be remotely controlled using DTMF codes.

There are 2 remote control functions:

◇ Mic DTMF remote

Controls the IC-2350H from the connected DTMF microphone. The optional HM-77/HM-95 DTMF MICROPHONE and optional UT-101 DTMF ENCODER/DECODER UNIT are required.

◇ External DTMF remote

Controls the main band's functions from another 144 or 430(440) MHz transceiver equipped with a DTMF encoder. An optional UT-101 DTMF ENCODER/DECODER UNIT and another control transceiver (equipped with a DTMF encoder) are required.

NOTE:

- The HM-95 is supplied with the U.S.A. version.
- For the U.S.A. version, attach the supplied microphone sheet to the HM-95 keyboard for operating convenience.
- In some countries, external DTMF remote may be contrary to radio law. Ask your Icom Dealer for details concerning your area of operation.

■ Mic DTMF remote operation

- ① Push [DTMF] 3 times to select standby for the remote control.
 - "REMO" appears.
- ② Push [UP] on the microphone to activate Mic DTMF Remote.
 - [UP/DN OFF] on the microphone must be set UP/DN.
 - "REMO" flashes.
- ③ While pushing [PTT], push the desired key on the microphone as described in the table on p. 42.
 - For the optional HM-77, there is no need to push [PTT].
- ④ Push [UP] again to cancel the function.
 - "REMO" stops flashing. The transceiver enters the standby condition for remote control.
- ⑤ Push [DTMF] to cancel standby for the remote control.
 - "REMO" disappears.

NOTE:

- The tuning dials and all switches including the PTT switch are electronically locked while "REMO" flashes.
- [UP] switch remote cannot be activated during standby for remote control ("REMO" appears). However, [DN] switch remote can be activated during standby for remote control.

14 OPTIONAL DTMF REMOTE

External DTMF remote presetting

◇ What are control and operation bands?

Control band	The sub band is used as the control band for control signal (DTMF code) receiving.
Operation band	The main band is used as the operation band for voice transmitting and receiving.

◇ Password setting

To prevent unauthorized control, program a 3-digit password into code channel 5, if required. The default setting of the transceiver is "000." If the password is not required, set code channel 5 as "receive inhibit." (p. 36)

◇ Control and operation band settings

- ① Push the control band's tuning dial.
 - "MAIN" appears for the control band.
- ② Set the control band's frequency.
- ③ Push the operation band's tuning dial.
 - "MAIN" appears for the operation band.
- ④ Set the operation band's frequency.
- ⑤ Set the operating frequency of the controlling transceiver to the control band's (sub band's) frequency.

External DTMF remote operation

- ① Set control and operation band frequencies in advance as at left.
- ② Push [DTMF] one or more times until "REMO" appears to select the remote standby condition.
- ③ From the controlling transceiver, transmit DTMF codes as follows.

- "SUB" and "REMO" flashes during external DTMF remote operation.

- Refer to p. 42 "Remote function tables" for each command.

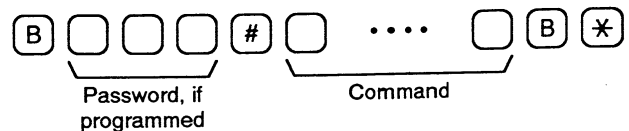

- ④ Push [DTMF] to cancel the remote standby condition.
 - "REMO" disappears.

NOTE:

- The tuning dials and all switches including the PTT switch are locked while "SUB" and "REMO" flashes.
- If an optional UT-89 TONE SQUELCH UNIT is installed, the tone squelch function can be used for the control band to increase remote control reliability. (p. 39)

Remote function table

KEY	DESCRIPTION	KEY	DESCRIPTION
[1] (CALL)	Selects the call channel for the main band.	[A] (CLR)	Clears input digits and retrieves the previous key input.
[2] (MR)	Selects memory mode for the main band.	[B]	No function.
[3] (VFO)	Selects VFO mode for the main band.	[C] (SPEECH)	No function. Used for the other model's voice synthesizer unit.
[4] (VHF)	Selects the VHF band as the main band.	[D] (ENT)	Erases the frequency and sets the digit stand-by condition. Enter a frequency using 5 digits or a memory channel number using 2 digits.
[5] (UHF)	Selects the UHF band as the main band.	[0]–[9] (after pushing [D])	Enters a frequency up to the 10 kHz digit or enters memory channels (1–52).
[6] (HIGH)	Selects high power for the main band.	[#] (UP)	Increases the operating frequency in preset tuning steps or the memory channel.
[7] (V•MONI)*	Opens and closes the VHF band's squelch.	[*] (DOWN)	Decreases the operating frequency in preset tuning steps or the memory channel.
[8] (U•MONI)*	Opens and closes the UHF band's squelch.		
[9] (LOW)	Selects low power 1 (lowest) for the main band.		
[0] (MUTE)*	Mutes both the VHF and UHF band's audio signals.		

* These functions are valid for mic DTMF remote only.

- In the following cases, the entered digits are cleared and the previous frequency or memory channel appears.
 - If the entered frequency is out of the frequency coverage.
 - If the entered memory channel number is 00 or larger than 52.

- The minimum-selectable digit is 10 kHz during digit key entry.
- To select scan edge channel 1A or 1b, enter memory channel number 51 or 52, respectively.

14 OPTIONAL DTMF REMOTE

Remote operation examples

◆ Mic DTMF remote examples

The HM-95 or HM-77 DTMF MICROPHONE is required.

[Example 1]

Setting the VHF band frequency to 145.0125 MHz.

(UP) 4 3 D 1 4 5 0 0 # (UP)
VHF VFO [ENT] Frequency setting [UP]
band mode

Set the VHF band tuning step to 12.5 kHz in advance.
(p. 13)

[Example 2]

Setting the UHF band memory channel 5.

(UP) 5 2 D 0 5 (UP)
UHF Memory [ENT] Channel setting
band mode

◆ External DTMF remote examples

Another 144 or 430(440) MHz transceiver equipped with a DTMF encoder is required.

[Example 1]

When the password "123" is programmed, setting the operation band (main band) to low output power.

(B) 1 2 3 # 9 (B) *
Password Low power

[Example 2]

When a password is not programmed, setting the operation band's (main band's) call channel to high output power.

(B) # 1 6 (B) *
Call High power
channel

■ Display dimmer setting

SET mode

Adjust the intensity to suit lighting conditions and personal preference.

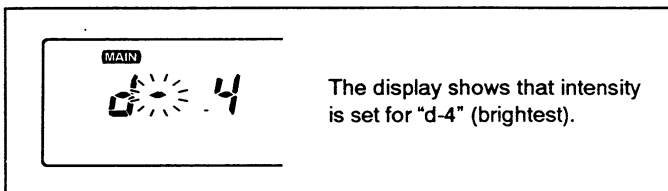

- ① Push [SET] one or more times until one of "d-1"–"d-4" appears as shown above.
 - Pushing [S.MW] reverses the order of selection. (p. 48)
 - Cancel pager or code squelch in advance. (pgs. 37, 38)
- ② Rotate the selected band's tuning dial to set the desired intensity.
 - The intensity level can be selected from 1 of 4 steps, d-1 (Dark) to d-4 (Bright).
- ③ Push the tuning dial to exit set mode.

■ Beep tones

INITIAL SET mode

You can select silent operation by turning beep tones OFF or you can select to have confirmation beeps sound at the push of a switch by turning beep tones ON.

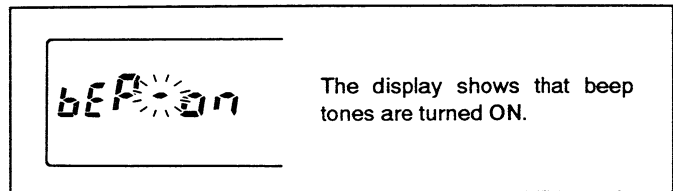

- ① Push [POWER] for 2 sec. to turn power OFF.
- ② While pushing [SET], turn power ON to enter initial set mode.
- ③ Push [SET] or [S.MW] one or more times until "bEP" appears. (p. 48)
- ④ Rotate the VHF tuning dial to select the condition.
 - "bEP-oF" : Beep tones are turned OFF.
 - "bEP-on" : Beep tones are turned ON.
- ⑤ Turn power OFF to exit initial set mode.

15 OTHER FUNCTIONS

■ Time-out timer INITIAL SET mode

To prevent extended continuous transmission with the crossband full duplex operation, etc., the transceiver has a time-out timer. This timer turns a transmission OFF 3, 5, 15 or 30 min. after it starts. This timer can be cancelled.

Approx. 10 sec. before the time-out time elapses, the transceiver emits a beep tone.

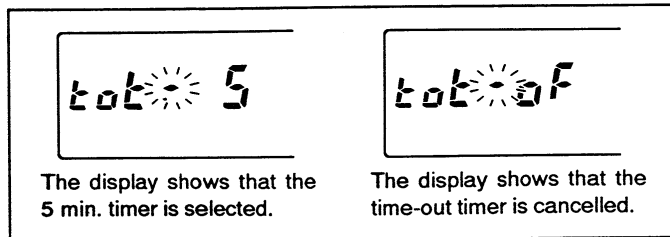

- ① Push [POWER] for 2 sec. to turn power OFF.
- ② While pushing [SET], turn power ON to enter initial set mode.
- ③ Push [SET] or [S.MW] one or more times until "tot" appears. (p. 48)
- ④ Rotate the VHF tuning dial to select the desired time-out time to 3, 5, 15, 30 min. or turn the timer OFF ("oF").
- ⑤ Turn power OFF to exit initial set mode.

■ Auto power-off INITIAL SET mode

The auto power-off function conveniently turns the transceiver power OFF after a preset time in which no operations are performed. In this way, when you forget to turn the power OFF, the transceiver automatically turns OFF itself, thereby conserving battery power.

The time can be set to 30 min., 1 hr., 2 hr. or turned OFF. The selected time is retained even when the transceiver is turned OFF by the auto power-off function. To cancel the function, select "oF" in step ④ below.

- ① Push [POWER] for 2 sec. to turn power OFF.
- ② While pushing [SET], turn power ON to enter initial set mode.
- ③ Push [SET] or [S.MW] one or more times until "PoF" display as shown at right. (p. 48)
- ④ Rotate the VHF tuning dial to select the desired auto power-off time to 30 min., 1 hr., 2 hr. or turn the timer OFF ("oF").
- ⑤ Turn power OFF to exit initial set mode.

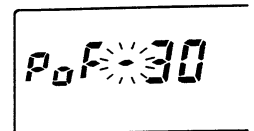

■ Cooling fan setting

INITIAL SET mode

The transceiver has a heatsink and cooling fan to radiate heat. The cooling fan automatically turns ON while transmitting and remains ON for 2 min. after transmitting. The cooling fan can be activated continuously, if desired.

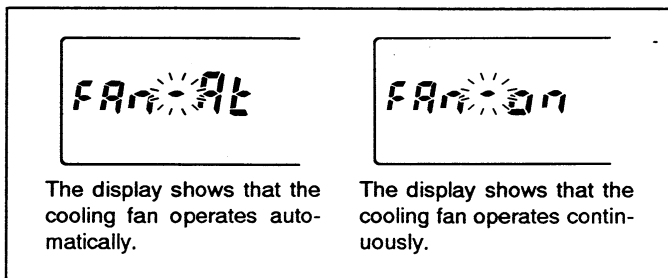

The display shows that the cooling fan operates automatically.

The display shows that the cooling fan operates continuously.

- ① Push [POWER] for 2 sec. to turn power OFF.
- ② While pushing [SET], turn power ON to enter initial set mode.
- ③ Push [SET] or [S.MW] one or more times to select the "FAN" display as shown above.
- ④ Rotate the VHF tuning dial to set the cooling fan to automatic ("At") or continuously ("on").
- ⑤ Turn power OFF to exit initial set mode.

■ Mono band operation

One of the bands can be deactivated to simplify operation.

- ① Turn the power OFF.
- ② While pushing a band's tuning dial, turn the power ON to deactivate that band.
 - To activate the masked band, turn power ON while pushing the deactivated band's tuning dial.

■ Demonstration display

A demonstration function is available at power ON. This function gives you a quick visual introduction to the function display indicators.

- ① While pushing [SET] and either VHF or UHF [VOL], push [POWER] for 2 sec. to turn power ON.
 - The transceiver cycles through a visual tour of the function display indicators.
- ② Push any switch to exit demonstration mode and enter the normal operating condition temporarily.
 - The transceiver automatically returns to demonstration mode after 2 min. in which no operations are performed.
 - The condition remains activated even when the power is turned OFF and ON again. Perform step ① to cancel.

16 MODE ARRANGEMENT CHART

Although the following chart refers only to the VHF band, the transceiver has the same mode arrangement in the UHF band.

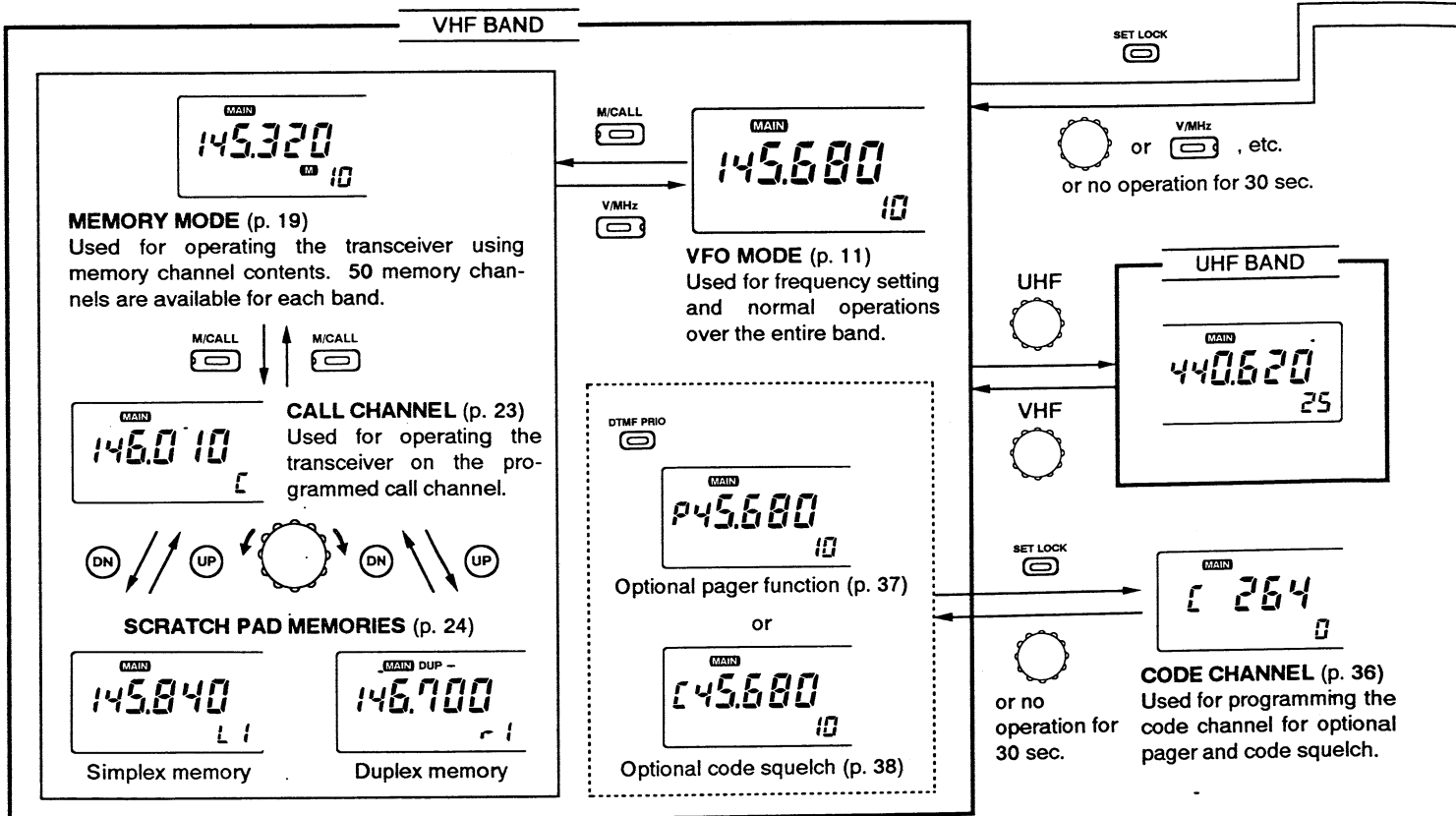

MODE ARRANGEMENT CHART 16

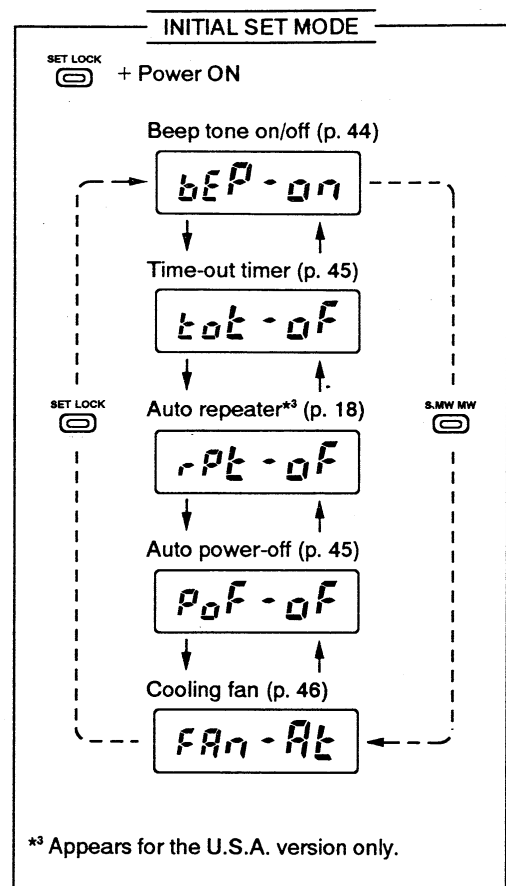
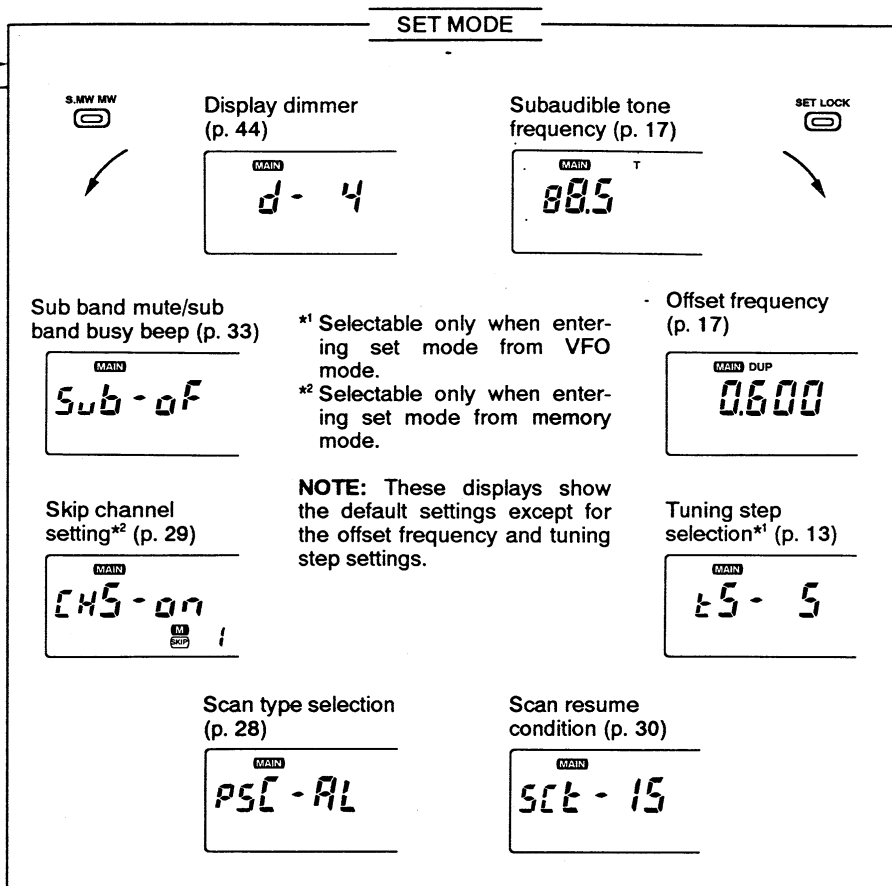

17 MAINTENANCE

■ Troubleshooting

If your transceiver seems to be malfunctioning, please check the following points before sending it to a service center.

PROBLEM	POSSIBLE CAUSE	SOLUTION	REF.
<ul style="list-style-type: none"> • No power comes on. 	<ul style="list-style-type: none"> • Power connector has a poor contact. • Polarity of the power connection is reversed. • Blown fuse. 	<ul style="list-style-type: none"> • Check the connector pins. • Reconnect the power cable observing the proper polarity. Replace the fuse, if damaged. • Check the cause, then replace the fuse. 	<p>—</p> <p>pgs. 8, 50</p> <p>p. 50</p>
<ul style="list-style-type: none"> • No sound comes from the speaker. 	<ul style="list-style-type: none"> • Volume level is low. • The squelch level is set too tight. • The optional pager, code squelch, pocket beep or tone squelch is turned ON. 	<ul style="list-style-type: none"> • Rotate [VOL] clockwise. • Set the squelch to the threshold point. • Turn the appropriate function OFF. 	<p>p. 14</p> <p>p. 14</p> <p>pgs. 37–39</p>
<ul style="list-style-type: none"> • Sensitivity is low and only strong signals are audible. 	<ul style="list-style-type: none"> • Antenna feed line or the antenna connector solder has a poor contact or is short circuited. • The RF attenuator is activated. 	<ul style="list-style-type: none"> • Check, and if necessary, replace the feed line or solder the antenna connector again. • Set the squelch to the threshold point. 	<p>p. 9</p> <p>p. 14</p>
<ul style="list-style-type: none"> • No contact possible with another station. 	<ul style="list-style-type: none"> • The transceiver is set to semi-duplex. • The other station is using code or tone squelch. 	<ul style="list-style-type: none"> • Set to simplex. • Turn ON the optional code squelch or tone squelch (UT-89 or UT-101 is necessary). 	<p>p. 16</p> <p>pgs. 38, 39</p>
<ul style="list-style-type: none"> • Repeater cannot be accessed. 	<ul style="list-style-type: none"> • Wrong offset frequency is programmed. • Wrong subaudible tone frequency is programmed. 	<ul style="list-style-type: none"> • Correct the offset frequency in set mode. • Correct the subaudible tone frequency in set mode. 	<p>p. 17</p> <p>p. 17</p>
<ul style="list-style-type: none"> • Frequency cannot be set. 	<ul style="list-style-type: none"> • The frequency lock function is activated. • Priority watch is paused on the watching frequency. 	<ul style="list-style-type: none"> • Push [SET•LOCK] to turn the function OFF. • Push the watching band's [V/MHz] to resume the watch. 	<p>p. 13</p> <p>p. 32</p>
<ul style="list-style-type: none"> • Transmission is automatically cut off. 	<ul style="list-style-type: none"> • Time-out timer is activated. 	<ul style="list-style-type: none"> • Set the timer to OFF in initial set mode. 	<p>p. 45</p>

PROBLEM	POSSIBLE CAUSE	SOLUTION	REF.
<ul style="list-style-type: none"> • Scan does not operate. 	<ul style="list-style-type: none"> • Squelch is open. • The selected scan edge memory channels (1A and 1b) have the same frequencies (for programmed scan). • All memory channels are programmed as skip channels (for memory scan). • Priority watch is activated. 	<ul style="list-style-type: none"> • Set the squelch to the threshold point. • Re-program the scan edges. • Cancel the memory skip function for the desired channels. • Push the watching band's [M/CALL] to turn the function OFF. 	<p>p. 14 p. 27</p> <p>p. 29 p. 32</p>
<ul style="list-style-type: none"> • The function display shows erroneous information. 	<ul style="list-style-type: none"> • The CPU is malfunctioning. 	<ul style="list-style-type: none"> • Reset the CPU. 	<p>p. 51</p>

■ Fuse replacement

If the fuse blows or the transceiver stops functioning, find the source of the problem if possible, and replace the damaged fuse with a new, rated fuse (20 A) as shown in the diagram below.

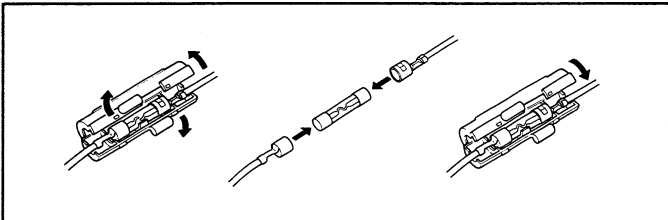

17 MAINTENANCE

■ Partial resetting

If you want to initialize the operating conditions (VFO frequency, VFO settings, set mode settings, etc.) without clearing the memory contents or initial set mode settings, a partial reset function is available for the transceiver.

- ① Push [POWER] for 2 sec. to turn power OFF.
- ② While pushing [DUP] and [LOW], turn power ON to partially reset the transceiver.
 - All programmed contents, except for memory contents (call and scratch pad memories included) and initial set mode settings are cleared, and the transceiver displays its initial VFO frequency display.

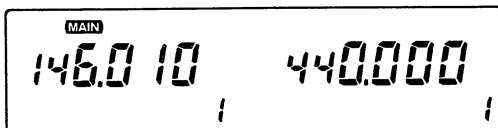

The display shows an initial VFO frequency display after partial resetting.

The frequency depends on version.

■ Total resetting

The function display may occasionally display erroneous information, (e.g., when first applying power). This may be caused externally by static electricity or other factors.

If this problem occurs, turn power OFF. After waiting a few seconds, turn power ON again. If the problem persists, perform the following procedure.

Partial resetting is alternatively available. See left for details.

NOTE: Resetting the CPU **CLEARs** all memory information, and initializes all values in the transceiver.

- ① Push [POWER] for 2 sec. to turn power OFF.
- ② While pushing [SET] and [S.MW], turn power ON.
 - All LCD segments appear momentarily, the initial display appears and the transceiver's CPU is reset.

SPECIFICATIONS 18

■ GENERAL

- Frequency coverage :

VERSION		144 MHz	430(440) MHz
U.S.A.	Tx	144–148 MHz	440–450 MHz
	Rx	118–174 MHz* ¹	
Asia	Tx	144–148 MHz	430–440 MHz
	Rx	136–174 MHz* ¹	
Europe		144–146 MHz	430–440 MHz
Italy	Tx	144–148 MHz	430–440 MHz
	Rx	136–174 MHz* ¹	

*¹ Guaranteed frequency coverage is 144–148 MHz.

*² Guaranteed frequency coverage is 430–440 MHz.

- Mode : FM
- Antenna impedance : 50 Ω (nominal)
- Power supply requirement : 13.8 V DC ± 15%
- Usable temperature range : – 10 °C to + 60 °C ; + 14 °F to + 140 °F
- Dimensions : 140(W) × 40(H) × 204.5(D) mm
(projections not included) 5 1/2(W) × 1 9/16(H) × 8 1/16(D) in
- Weight : 1.2 kg; 2 lb 10 oz

■ TRANSMITTER

- Modulation system : Variable reactance frequency modulation
- Max. frequency deviation : ± 5.0 kHz
- Spurious emissions : Less than – 60 dB
- Microphone impedance : 600 Ω

- Output power and current drain:

CONDITION		POWER	CURRENT
144 MHz	High	50 W	11.5 A
	Low 2	10 W	6.0 A
	Low 1	5 W	4.5 A
430(440) MHz	High	35 W	11.0 A
	Low 2	10 W	6.0 A
	Low 1	5 W	4.5 A

■ RECEIVER

- Receive system : Double-conversion superheterodyne
- Intermediate frequencies :
144 MHz 1st 17.2 MHz 2nd 455 kHz
430(440) MHz 1st 30.85 MHz 2nd 455 kHz
- Sensitivity (for 12 dB SINAD): Less than 0.16 μV (typ.)
- Squelch sensitivity (at threshold): Less than 0.13 μV
- Selectivity : More than 15 kHz/ – 6 dB
Less than 30 kHz/ – 60 dB
- Spurious response rejection ratio : More than 60 dB
- Audio output power : More than 2.4 W at 10% distortion with the 8 Ω internal speaker.
- Current drain :
Rated audio output on both bands 1.8 A
Squelched on both bands 1.2 A

All stated specifications are subject to change without notice or obligation.

19 OPTIONS

Options

Some versions cannot use all of the following options since electrical standards, etc. vary between countries. Ask your Icom Dealer which options are available.

SP-7 EXTERNAL SPEAKER

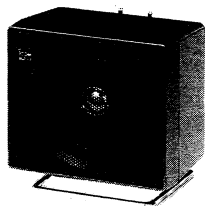

Cable length: 1.0 m; 3.3 ft

SP-10 EXTERNAL SPEAKER

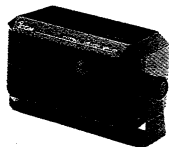

Cable length: 1.5 m; 4.9 ft

SP-12 EXTERNAL SPEAKER

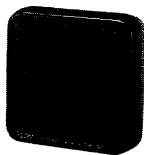

Cable length: 2.0 m; 6.6 ft

MB-17A MOBILE MOUNTING BRACKET

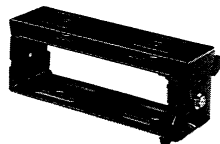

One-touch bracket. Transceiver body is easily attached and removed.

AH-32 144/430(440) MHz DUAL BAND ANTENNA

Dual band mobile antenna.

Frequency range : 144–148 MHz and 430–450 MHz

Max. input power : 150 W

AHB-32 TRUNK MOUNT

Trunk mount with a coaxial cable for the AH-32.

HM-77 DTMF MICROPHONE

Has a DTMF function and 14 DTMF memory channels. Provides remote control functions with the optional UT-101. Also has a 1750 Hz tone call function.

HM-78 HAND MICROPHONE

Streamlined microphone provides a comfortable grip.

HM-79 HAND MICROPHONE

Streamlined microphone provides a comfortable grip. Has a 1750 Hz tone call function.

HM-95 DTMF MICROPHONE

Provides remote control functions with the optional UT-101. Same as supplied with the U.S.A. version. For the Europe and Italy versions, the HM-77 is recommended due to 1750 Hz tone call capability.

HM-96 HAND MICROPHONE

Same as supplied with the Asia and Australia versions.

HM-97 HAND MICROPHONE

Same as supplied with the Europe and Italy versions. Has a 1750 Hz tone call function.

OPC-346 DC POWER CABLE

Same as supplied with the transceiver. (20 A, 3 m; 9.8 ft)

OPC-347 DC POWER CABLE

Has 20 A capacity and a length of 7.0 m (23.0 ft).

OPC-589 MIC CONVERSION CABLE

Converts a metal connector microphone, such as the HM-56, etc. to an 8-pin modular plug.

IC-PS30 DC POWER SUPPLY

Provides 13.8 V DC and 25 A max. for base station use.

UT-89 TONE SQUELCH UNIT

Provides pocket beep, tone squelch and tone scan functions.

UT-101 DTMF ENCODER/DECODER UNIT

Provides pager, code squelch and DTMF remote functions.

Count on us!

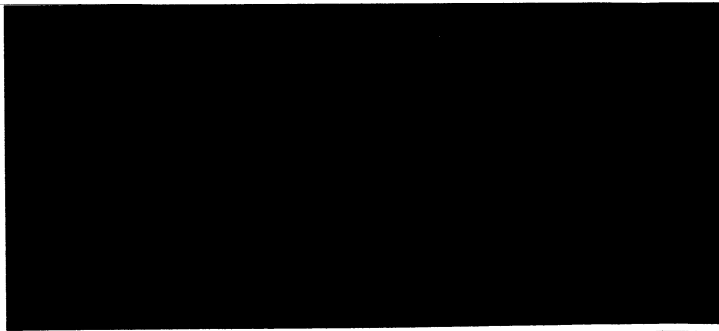

A-5357S-1EX
Printed in Japan
Copyright © 1995 by Icom Inc.

Icom Inc.
6-9-16 Kamihigashi, Hirano-ku, Osaka 547 Japan