

PK-96

Operating Manual

Timewave Technology Inc.
58 E. Plato Blvd.
St. Paul, MN 55107

<http://www.timewave.com>

July 1997

Welcome

Thank you for purchasing an Timewave/AEA product! Before you go any further, please fill out and return the enclosed Warranty Registration Card. From time to time, Timewave offers updates to its products—we can only tell you about these updates if we have your warranty card on file, so send it in if you haven't already done so.

FCC Regulations

This device complies with Part 15 of the FCC rules. These rules are designed to provide reasonable protection against harmful interference in a residential installation. This device generates, uses, and can radiate radio frequency energy and, if not installed and used in accordance with the instructions, may cause harmful interference to radio communications. However, there is no guarantee that interference will not occur in a particular installation. If this device does cause harmful interference to radio or television reception, which can be determined by turning the device off and on, the user is encouraged to try to correct the interference by one or more of the following measures:

- Reorient or relocate the receiving antenna.
- Increase the separation between the device and receiver.
- Connect the device into an outlet on a circuit different from that to which the receiver is connected.
- Consult the dealer or an experienced radio/TV technician for help.

Changes or modifications not expressly approved by the manufacturer will void the user's authority to operate the device.

You must use shielded cables for all device connections, then tie all grounding wires/shields to a single point, normally the radio. You need an effective station ground or you'll have problems when RFI infiltrates your equipment and causes all kinds of unexpected problems.

Disclaimer

As part of its continuing program of product improvement, Timewave reserves the right to make changes in this product's specifications or documentation. Timewave also reserves the right to incorporate and issue any information thus supplied in whatever manner it deems suitable, without incurring any obligations whatsoever.

Copyright

©1997 by Timewave Technology Inc. All rights reserved.

Under the copyright laws, this manual can't be reproduced in any form without prior written permission from Timewave Technology Inc. No patent liability is assumed, however, with respect to the use of the information contained herein.

This manual may contain errors, omissions or "typos." Please send your comments, suggestions and corrections to: Timewave Technology Inc., 58 E. Plato Blvd, St. Paul, MN 55107.

APRS is shareware and is a copyrighted product of APRS Software, Bob Bruninga. APRS is his trademark.

PK-96

Operating Manual

Timewave Technology Inc.
58 E. Plato Blvd.
St. Paul, MN 55107

<http://www.timewave.com>

July 1997

Welcome

Thank you for purchasing an Timewave/AEA product! Before you go any further, please fill out and return the enclosed Warranty Registration Card. From time to time, Timewave offers updates to its products—we can only tell you about these updates if we have your warranty card on file, so send it in if you haven't already done so.

FCC Regulations

This device complies with Part 15 of the FCC rules. These rules are designed to provide reasonable protection against harmful interference in a residential installation. This device generates, uses, and can radiate radio frequency energy and, if not installed and used in accordance with the instructions, may cause harmful interference to radio communications. However, there is no guarantee that interference will not occur in a particular installation. If this device does cause harmful interference to radio or television reception, which can be determined by turning the device off and on, the user is encouraged to try to correct the interference by one or more of the following measures:

- Reorient or relocate the receiving antenna.
- Increase the separation between the device and receiver.
- Connect the device into an outlet on a circuit different from that to which the receiver is connected.
- Consult the dealer or an experienced radio/TV technician for help.

Changes or modifications not expressly approved by the manufacturer will void the user's authority to operate the device.

You must use shielded cables for all device connections, then tie all grounding wires/shields to a single point, normally the radio. You need an effective station ground or you'll have problems when RFI infiltrates your equipment and causes all kinds of unexpected problems.

Disclaimer

As part of its continuing program of product improvement, Timewave reserves the right to make changes in this product's specifications or documentation. Timewave also reserves the right to incorporate and issue any information thus supplied in whatever manner it deems suitable, without incurring any obligations whatsoever.

Copyright

©1997 by Timewave Technology Inc. All rights reserved.

Under the copyright laws, this manual can't be reproduced in any form without prior written permission from Timewave Technology Inc. No patent liability is assumed, however, with respect to the use of the information contained herein.

This manual may contain errors, omissions or "typos." Please send your comments, suggestions and corrections to: Timewave Technology Inc., 58 E. Plato Blvd, St. Paul, MN 55107.

APRS is shareware and is a copyrighted product of APRS Software, Bob Bruninga. APRS is his trademark.

Table of Contents

FCC Regulations	ii
<hr/>	
Introduction	ix
Typographical Conventions	ix
Abbreviations used throughout the manual	x
<hr/>	
1. The PK-96	1
Capabilities & Features	1
What Did—and Didn't—Come In the Box	1
Your Radio	2
... and Computer	2
A Tour of the PK-96	2
<hr/>	
2. Power Supply and Computer Installation	4
Connecting Power	4
Turning it On	4
Re-Initialization	5
Connecting Your Computer to the PK-96	5
The Cable	5
Apple Computers	6
Dumb Terminals	6
The Computer	6
Other Computers with RS-232 Ports	6
Other Computers with Non-Standard Serial Ports	7
Peripherals and IRQ Conflicts in PC Compatibles	7
The Software	8
PC Compatible Computers	8
Macintosh	9
System Start-up and Loop-back Test	9
<hr/>	
3. Radio Installation	12
If You Just Want to Listen	12
To Transmit and Receive.	12
Radio Connection Requirements	12
Connections for Specific Transceivers	13
Basic Connections and Adjustments	13
Transceiver Adjustments	15

Radio Connection Requirements for 9600 bps Operation	16
Adjusting the PK-96's Deviation	16
Radio Connections	16
Other Radios	18
Crystal-Controlled FM Transceivers	18
"Mod" Notes for Specific Radios	19
Packet Parameters	23
<hr/>	
4. You're in Command	25
Parameters and Arguments	25
Boolean	25
Numeric	25
Text or String Arguments	25
Changing Commands	26
List of Commands	26
Host Mode Abbreviations	26
PK-96 Command List	77
<hr/>	
5. Packet Operation	80
The Packet Modes	80
Tuning in Packet Stations — VHF/UHF	80
What It Means	81
Who's Out There?	82
Talking to Yourself	83
Connecting	83
CTEXT	84
Connect/Disconnect Notification (CBELL)	85
Setting Up for Transmitting	85
Calling CQ	85
Going On the Air	85
I'm Having Trouble Connecting	86
More Packet Features	86
Nodes and Node Operation	86
Operating Your Node	87
Digipeating	89
Are You a Digipeater?	90
Identifying as a Digipeater	90
Time-stamping Packets and Messages	90
Multiple Connection Operation	91
Setting Up	91
The Channel Switching Character	91
CHCALL	92
Checking Your Connect Status with CSTATUS	92
Packet Meteor Scatter Extension	92
Intermediate and Advanced Commands	93

1200/9600 bps Operation	93
Monitoring Other Stations	93
Monitoring the Packet Networking Switches	93
Selective Monitoring	93
MFILTER	94
Monitor Without Call Sign Headers	94
Beacon Operation	94
Packet Transmit Timing	94
Packeting Through Voice Repeaters	95
Packet Formatting and Editing	95
(RETURN)'s and Linefeeds	95
Cancelling Lines and Packets	95
Redisplaying Text	95
The PASS Character	95
Packet Protocol Basics	96
Connected Packets	96
FRACK and RETRY	96
PACLEN and MAXFRAME	96
Reducing Errors through Collision Avoidance	97
DAMA	97
CHECK and RELINK	97
Transparent Mode	98
Full-Duplex Operation	98
Morse ID in Packet	98
The QRA Feature	98
Packet Mail	98

6. MailDrop Operation	99
MailDrop Memory	99
Setting Up Your MailDrop	99
Accessing and Commanding Your MailDrop	100
Monitoring Your MailDrop	100
MailDrop Prompts and Operation	101
MailDrop Command Summary	101
Sending Mail	104
From the Console Operator	104
Sending Other Types of Messages	104
From the User's Point of View	105
The Console operator's Point of View	106
Message Numbers	107
Forwarding and Reverse-Forwarding	107
Settings for Auto-Forwarding	108
Entering a Message for Reverse Forwarding	108

7. GPS Operation	109
Overview	109
Why do GPS in the PK-96?	109
Hardware Configurations	110
Installing APRS	112
To install APRS on your hard drive	112
Getting Started	112
Setting Up the PK-96 for GPS Operation	112
Stand Alone Tracking Device Set Up	112
Connecting the GPS receiver to the PK-96	113
APRS Hardware Single Port Mode Set Up	114
APRS Dual Port Mode Set Up	115
Building your own APRS adapter cable	115
Schematic Diagram for the APRS Adapter Cable	116
PK-96/Ultimeter II Stand Alone Weather Station Set Up	116
Wireless Data/Location Tracking Applications	117
Configuring the TNC	117
Connecting the GPS Adapter Cable to the TNC	119

8. Troubleshooting	120
A Troubleshooting Primer	120
The Power Supply	121
The Power Supply Cable	121
The PK-96	122
Cable from PK-96 to Computer	122
Computer/Software	122
Cable From PK-96 to Radio	122
Radio	122
If You Need to Call for Help	122
General Error Messages	123
Packet Error Messages	124
MailDrop Error Messages	125
PK-96 Status and Error Messages	126
Out-of-the-Box Problems	126
Computer to PK-96 Problems	127
Radio to PK-96 Problems	128
MailDrop Problems	128
Packet Problems	129
PK-96 Problems	133

Appendix A: Radio Connections 134

- Radio Connection Notes 134
- Radio Listings 135
- Radio Connection Diagrams 139

Appendix B: Parts List, Schematics, and Pictorial Diagram 144

Appendix C: Specifications 149

- Modem Characteristics 149
- Processor System 149
- Input/Output Connections 149
- Controls and Indicators 149
- General 149

Appendix D: Upgrading the PK-96 150

Appendix E: Understanding High Speed Modems 151

- PK-96 connections 151
- More on TX and RX 'Audio'... 151
 - Some audio basics first... 151
 - 1200 bps 152
- Theory of Operation for the Demodulator 153
- 9600 bps 153

Appendix F: Limited Warranty 155

Appendix G: PK-96 TheNet Node Option 156

Index 157

This page left intentionally blank

Introduction

Overview

The PK-96 is a 1200/9600 baud, packet-only controller that sets a new standard in the amateur radio world. As a new owner, however, you're probably bewildered by its scores of commands and their functions, besides wondering what all those lights on the front panel do or mean.

Take heart: You don't need to be a rocket scientist to understand how to hook up your PK-96 and operate it, but you do need to have an understanding of basic electronics so you can make the necessary (and correct) connections to your station equipment. You also need to have a working knowledge of your computer's software, hardware and operation.

Just as a car's owner's manual isn't written to teach you how to drive, this one won't go into the electronics, operation, or theory behind the modes that are available with the PK-96. Many fine books are available describing packet operation in detail, so please refer to them if your interest in the PK-96's operating modes extends beyond their practical application.

Here are some excellent sources for reading more about packet and packet operation:

- The Radio Amateur's Digital Communications Handbook by *Jonathan Mayo, KR3T*; TAB Books, ISBN 0-8306-8362-3 (hardback.) and 0-8306-3362-6 (pbk.).
- The ARRL Operating Handbook and Your Packet Companion by *Steve Ford*.

Both of the above are available from the ARRL, 225 Main Street, Newington, CT 06111-1541 or your local ham radio dealer.

Typographical Conventions

To set off special text, this manual uses the following typographical conventions:

<i>This kind of type</i>	identifies variables for which you enter values (for example, MYCALL WF7A).
This kind of type	indicates a section of importance.
This kind of type	identifies text generated by your PK-96. Examples include screen menus, prompts, and error messages.
This kind of type	identifies characters you type and controller commands. <i>Example:</i> DISP Z

Combinations of keystrokes are joined by a minus sign (-). For example, if you're instructed to press the Control (CTRL) key and the letter "Z" at the same time, the keystroke will be shown as (CTRL-Z). Release all keys simultaneously.

Key names like (ENTER), (RETURN), (SHIFT), (CTRL), and (SPACE BAR)—when used as a verb—mean press the key. After entering any command into your PK-96, you'll always press the (RETURN) or (ENTER) key. So, whenever the word "enter" is used, it means to enter a command or text from your keyboard, then press the (ENTER) or (RETURN) key; Throughout this manual we'll refer to this key as (RETURN).

Abbreviations used throughout the manual

ack	Acknowledge
call	Call sign
CTRL	control
DCD	Data Carrier Detect
ESC	escape
FSK	Frequency Shift Keying
HF	High Frequency
LF	Line feed
mS	Milli-second
<i>n</i>	A variable which you substitute a number or letter
nack	Not Acknowledge
PTT	Push-To-Talk
UHF	Ultra High Frequency
VHF	Very High Frequency

1. The PK-96

Overview

The PK-96 was designed to provide you with a superior packet operating platform when connected to your computer and a VHF or UHF transceiver.

Capabilities & Features

- AX.25 levels 1 & 2, 1200/9600 bps packet operation in the Command, Host and KISS modes.
- 18K mailbox (expandable to 100K with upgrade option, *see Appendix D*).
- Gateway for node operation.
- Can be a 1200/9600 bps component in a TheNet node stack with Timewave's TheNet upgrade.
- GPS firmware which is remotely programmable, can be remotely polled, and is compatible with GPS, Loran, ARNAV, and Ultimeter II. Optional APRS Adapter Cable available. The GPS firmware also allows for Stand Alone Tracking and automatically detects GPS receivers at power-up.
- Software included: PC PakRatt Lite™ the packet-only, DOS control program, and APRS™ the GPS mapping and tracking program developed by Bob Bruninga, W4APR.
- Compatible with many terminal control programs, including Timewave's own PC PakRatt II for DOS, PC PakRatt for Windows 2.0.
- Hardware "true DCD" state machine so you can open the squelch and hear weak signals.
- Hardware HDLC controller guarantees accurate protocol conversion at 9600 bps.
- Modem disconnect header for installing even faster modems.
- Separate external 1200/9600 transmit level controls.
- DAMA support for master/slave node communications.
- Enhanced MHEARD function identifies TCP/IP, NET/ROM, and <The-Net> stations.
- EXPERT command included to ease the learning process—only the most common commands will be usable until the EXPERT mode is enabled.
- Independent operation—once your PK-96 is up and running, you can turn off your computer or use it to do something else; the PK-96 will independently accept connects, receive and forward mail, and act as a node as long as power is supplied to it and your radio is on.

What Did—and Didn't—Come In the Box

Besides this manual, the following items are enclosed:

- A cable to connect your PK-96 to a radio.
- A computer disk containing PC PakRatt Lite™ and APRS™ software. (*Information on how to install PC PakRatt Lite is written in Chapter 2. Information on how to install APRS is written in Chapter 7.*)
- An audio cable.
- A power cable.

Here's what *isn't* enclosed:

- An RS-232 Serial Cable with DB-25 connectors (pins 1-8 and 20 connected).
- A microphone connector for your radio.

- A power supply.
- A computer and a radio.

The PC PakRatt Lite software included with the PK-96 is for those who have no other terminal control program to use. The PK-96 will work with practically any telephone modem or terminal emulation program that your computer can run, as long as it uses the full ASCII character set. *PC-Pakratt-II*, and *PC-Pakratt for Windows* are more powerful programs than PC PakRatt Lite offered by Timewave and are tailor-made for its controller products. These programs offer many operating niceties and utility features that simply aren't found in typical modem or third-party controller programs.

We didn't enclose a mike connector because we don't know which brand or model of radio you plan to use with your PK-96.

Finally, we didn't include a power supply since many owners simply connect their PK-96 to the same supply that powers their radio and station accessories. If you want to operate your PK-96 from a "power cube" that plugs into your wall outlet, you can purchase one locally or you can purchase the Timewave AC-1 power supply directly from Timewave or through our dealers. (We recommend using a regulated, stand-alone power supply for the PK-96 to avoid possible ground loop or insufficient power problems associated with using your station's main power supply.)

Your Radio ...

We presume that you have an operating radio transceiver that you'll use with your PK-96. (Specific transceiver connections are described in Appendix A.) In the amateur bands, most of the VHF packet activity occurs on the 2-meter FM band, with "backbone" systems residing in the 1.25-meter and 70cm bands.

Most radios require modification for sending packet at 9600 bps, and some radios *can't* operate at 9600 bps. Check Chapter 3 — *Radio Connection Requirements for 9600 bps Operation* for a brief list of radios that we know (at press time) work at 9600 bps. If your radio isn't listed there, call your radio's manufacturer for possible modification instructions.

... and Computer

You'll need a computer or dumb terminal that has an RS-232 serial communications port so it can communicate with your PK-96. The most popular computers are PC compatibles, laptops, and Apple® computers like the Macintosh, Powerbooks, and Performas.

For the sake of brevity in this manual, instead of using "dumb terminal" and "computer" interchangeably we'll just use one word, "computer."

A Tour of the PK-96

Before you leap ahead into the next chapter to see how to hook up your PK-96, you should read this section to find out what all those LED's, switches and connectors are and what they do. If their functions or terms sound cryptic to you now, don't worry about it—they'll be explained fully in later chapters.

First, carefully remove the PK-96 from its protective bag and inspect it for signs of damage that may have occurred during shipment. If there's any visible damage, please contact the dealer or shipper immediately. *Don't install or use a damaged controller.*

Now, set it on the table or hold it in your hands and spend a few minutes here to take a guided tour of your controller starting from the front, left-hand side. (Refer to the illustration on the next page)

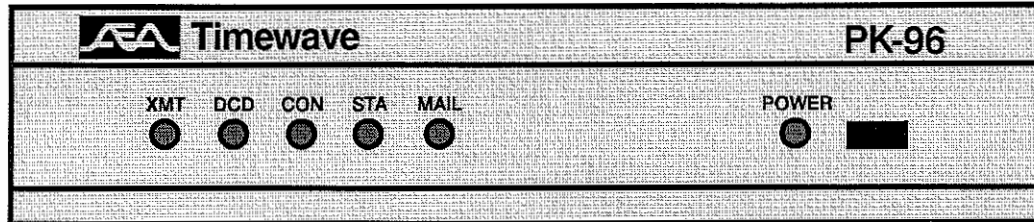

Front View of the PK-96

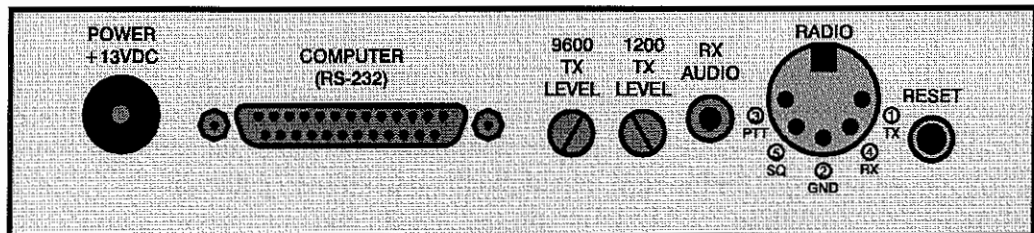

Rear View of the PK-96

XMT lights up when the PK-96 keys your transmitter's PTT (Push-To-Talk) line.

DCD, or Data Carrier Detect, lights up when the PK-96 hears something, be it noise or a signal.

CON, or CONnected, glows when you're "connected" to someone in packet.

STA, or STATus, glows when you've sent a packet that hasn't yet been acknowledged (*acked*) by a connected station.

MAIL lights up to let you know you've received mail.

To the right of the LED's is the POWER indicator light and ON/OFF power switch. With the switch in, the PK-96 powers up and the POWER light is on; when the switch is out, it's off.

Turn the PK-96 around so you can see all the connectors on the back (see above). Starting from the left is the POWER receptacle. The center pin is (+) and the ring, or outside, is (-).

Continuing to the right is the RS-232 I/O receptacle, where you'll plug in the cable that connects to the serial port on your computer.

Next is the 9600 TX potentiometer you'll adjust to set the amplitude of the audio signal going from the PK-96 to your radio for 9600 bps operation. This is usually a onetime adjustment for the model of radio you plan to use.

1200 TX LEVEL performs the same function as the 9600 TX potentiometer, but for 1200 bps operation. Again, this is usually a onetime adjustment for your model radio.

The RADIO connector is where you'll plug in the cable going from your radio's mike connector to the PK-96.

Finally, the RESET button. You'll push this button to reset the TNC's parameters to its factory-set defaults or to restart the TNC.

This ends your tour. Let's move on to the next chapter where you'll hook up a power supply and your computer to the PK-96.

2. Power Supply and Computer Installation

Overview

In this chapter, you'll power up the PK-96 and connect it to the RS-232 serial port of your computer. After the connections have been made, you'll do a quick check of the PK-96's internal firmware and internal modem by performing the all-important "loop-back" test. When you've completed this chapter, you'll be ready to connect the PK-96 to your transceiver and begin using it on the air.

Connecting Power

Before you hook up anything to your computer, you need to connect power to your PK-96. To prevent any potential accidents, make sure the proposed power supply is off and unplugged before connecting the PK-96 to it.

If you have a ready-made power supply like Timewave's AC-1, insert the coaxial connector into the PK-96's PWR receptacle, plug the "power cube" into the wall, and skip ahead to the *Turning it On* section.

If you are not using a ready-made power supply, locate the power cable in the enclosed accessory bag (the black one with a white stripe running down the length of one of its conductors) and strip off enough insulation from the ends of both conductors to connect it to your 12-14 VDC *regulated* power supply.

IMPORTANT:

Your power supply must provide at least 12 VDC @ 400mA under load for the PK-96 to operate reliably.

Fasten or solder the positive (+) lead—the one which has the white stripe running down its length—to the (+) terminal of your power supply. Connect the other conductor to the negative (-) terminal of your power supply. Insert the coaxial power plug into the POWER receptacle on the left rear of the PK-96.

Turning it On

With the power connections made, turn on the PK-96's power supply (or plug the power cube into the wall outlet), then press the POWER switch on the front of the PK-96. Watch closely for this start-up light pattern: five LED's—DCD, CON, STA, MAIL, and POWER—should light. If this occurs, then switch off the PK-96 and move on to the section, *Connecting Your Computer to the PK-96*.

If none of the red LED's are lit upon power-up but the green POWER light is on, then the controller has been previously initialized and set to your computer's current TBAUD speed—it has already passed the autobaud routine, which will be described shortly.

If either of the above doesn't happen, go to *Chapter 7 - Troubleshooting*.

Re-Initialization

If the PK-96 has been previously initialized, it's ready to communicate with a computer at a baud rate of 300, 1200, 2400, 4800 or 9600 bits/sec. If you're new to TNC operation, we suggest you re-initialize the PK-96 now so you'll have an easier time getting it up and running later. **Reinitializing the controller will make it "forget" all of its user-defined parameters and will return it to its default settings from the factory.**

To re-initialize the PK-96, turn off the controller, hold in the RESET button on the back of the unit and push the POWER button to energize the PK-96. After a couple of seconds, release your finger from the RESET button. The controller should go through its normal start-up routine outlined in the previous section. If this procedure didn't restore the proper start-up operation of the PK-96's front panel LED's, refer to *Chapter 7 - Troubleshooting*.

Connecting Your Computer to the PK-96

NOTE:

Make sure that the PK-96 and computer are turned off before proceeding.

The Cable

For communication to take place between your computer and the PK-96, you need a properly wired shielded cable that will connect the computer's serial port to the RS-232 I/O port on the back of the PK-96.

The style of connector you have on your computer probably looks like one of these:

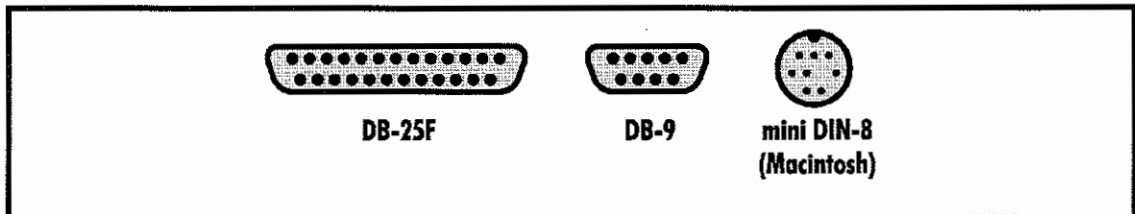

Here's a table of pin assignments to wire the PK-96's RS-232 I/O port to a typical computer's serial port:

from PK-96 RS-232 I/O	to... DB-25F	DB-9	Apple mini- DIN-8P	Function
8	8	1	2	(DCD)
3	3	2	5	(RxD)
2	2	3	3	(TxD)
20	20	4	1	(DTR)
7	7	5	4+8	(GROUND)
6	6	6		(DSR)
4	4	7		(RTS)
5	5	8		(CTS)
1	1			Shield

Don't use a "null modem" cable. This type of cable flips pins 2 & 3 so that pin 2 on one end of the cable is connected to pin 3 on the other end (and vice versa). Use a cable that has "straight through" connections like the ones used to connect computers to a telephone modem, since as far as your computer is concerned, the PK-96 is a modem.

If you're using a computer that has a DB-9 connector for its serial port, you can purchase an adapter from Radio Shack that will work with the supplied computer cable.

Once you've tested the cable to make sure it's pinned correctly, plug one end into your computer's serial port and the other end to the RS-232 I/O port on the back of the PK-96. Then, proceed to the *System Start-up and Loop-back Test* section in this chapter.

Apple Computers

For the older Macintosh 128 and 512 machines, a DB-9 to DB-25 adapter cable is needed. If you own a late-model Macintosh, simply use a standard mini-DIN8 to DB-25M modem cable.

Dumb Terminals

If you have an RS-232 dumb terminal, you may need to change the gender of the cable provided with your PK-96. This can be done with an inexpensive double-male RS-232 gender changing adapter available from Radio Shack and other computer dealers. The Radio Shack part number is 26-243.

The Computer

If the type of computer you plan to use with the PK-96 wasn't mentioned earlier in this chapter, you may find specific connection information below. You'll also need a communications program to use with your computer. See *The Software* section following this one for information regarding communication programs for many of the above machines.

Computers that don't have a serial port or permit use of a suitable adapter or level converter can't be used with the PK-96.

Other Computers with RS-232 Ports

If your computer has an RS-232 port, consult your computer manuals to see which pins are used for TxD, RxD, and signal ground. Read the manufacturer's recommendations for connecting the serial port to a telephone modem. Connect your PK-96 the same way.

The PK-96 is configured as Data Communications Equipment (DCE)—it receives data on pin-2. Most computers and terminals are configured as Data Terminal Equipment (DTE) transmitting data on pin-2.

If your computer is configured as DTE, use the supplied RS-232 cable with a gender changing adapter, if necessary. These are available from Radio Shack (catalog# 26-243) and other computer stores.

If your computer is configured as DCE, wire it like this:

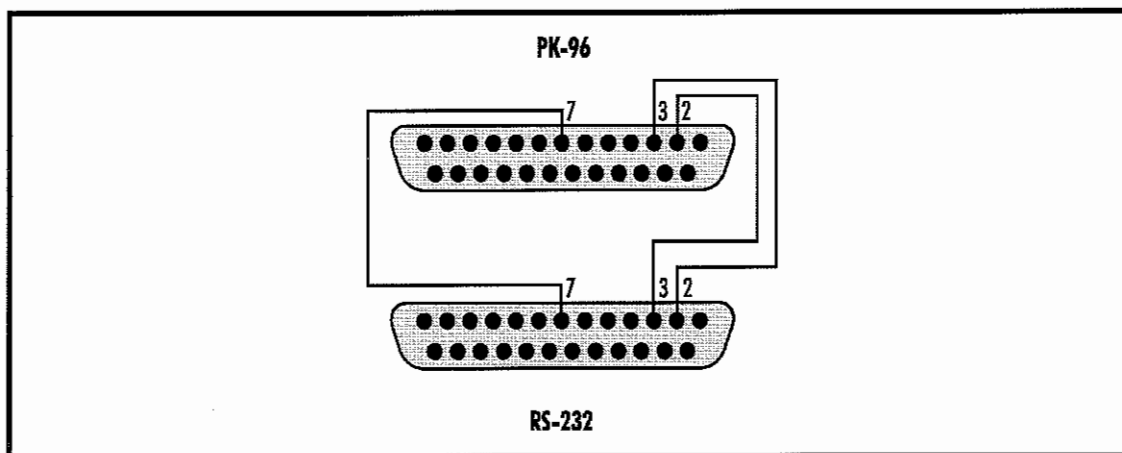

- Wire pin 2 of the PK-96 to pin 3 of the RS-232 computer connector.
- Wire pin 2 of the computer's RS-232 connector to pin 3 of the PK-96.
- Wire pin 7 to pin 7.

Other Computers with Non-Standard Serial Ports

Computers with nonstandard serial ports must meet the following conditions:

- The signal levels must be compatible with RS-232C. The PK-96 requires the voltage levels from the computer to be greater than +3 volts in the "asserted" state and 0 volts or less in the "non-asserted" state.
- The signal polarity must conform to the RS-232C standard. The 0 or negative-voltage state must correspond to logical "1" and the positive-voltage state to logical "0."
- The computer must be able to correctly receive a signal that meets asynchronous RS-232C specifications. The PK-96 supplies signals that meet this specification.

Make or buy a cable that provides the following connections:

- The computer's serial port signal ground or common pin must be connected to the PK-96's serial port connector, pin 7.
- The pin on which the computer *sends* data (TxD) must be connected to the PK-96's RS-232 connector, pin 2.
- The pin on which the computer *receives* data (RxD) must be connected to the PK-96's RS-232 connector, pin 3.

If your computer requires any other signals, you must arrange to provide them. The PK-96 has the standard hardware handshake lines available. As a default, the PK-96 provides XON/XOFF software flow control to the computer or terminal. The command, XFLOW, can be turned off, disabling software flow control and enabling hardware handshake if your computer requires it. Hardware flow control is achieved with RTS/CTS (pins 4 and 5) of the DB-25 RS-232 I/O connector. The documentation provided with your computer or serial card should clarify any special requirements.

Peripherals and IRQ Conflicts in PC Compatibles

On a different note, you need to survey your computer system to see what peripherals are connected to it, both internally and externally. This is important since you may not be able to readily connect the PK-96 to a COM port that's shared or occupied by another device like a modem, fax, or mouse card. For example, you may not be able to connect your PK-96 to COM 1 if COM 3 is occupied by another device; the same holds true with COM 2 and COM 4. COM ports are usually paired, meaning COM 1 "sees" what's connected to COM 3, and COM 2 sees what's connected to COM 4.

The reason you have to be careful with COM port pairs is something called an Interrupt ReQuest (IRQ) conflict—devices and peripherals send a distinct set of signals back to the CPU to interrupt its operation when the device needs attention. When two devices have the same IRQ codes, their signals fight for the CPU's attention and cause all kinds of trouble. Therefore, if COM 1 or COM 3 is occupied, connect the PK-96 to COM 2 or COM 4 if you can. If you can't, you'll have to change the hardware (and software) to another IRQ so the shared devices can "live together" on the paired ports. Changing the other device's IRQ from 3 to IRQ 5 usually works. (Refer to the device's manual for changing its IRQ setting.)

Along the same lines as conflicts, sometimes a TSR (Terminate and Stay Resident) program can cause a communication problem between the PK-96 and your computer. Therefore, when setting up your control-

ler for the first time, disable all of your TSRs to eliminate any potential start-up problems. An easy way to do this is to create a system disk on a "floppy" (in DOS, type `FORMAT A: /S` to create a system disk), start-up your computer from that disk, then access the communications program you plan to use with your PK-96.

To prevent programs from automatically booting in your Macintosh or Powerbook, simply hold down the (SHIFT) key on power-up until you see the Welcome to Macintosh, Extensions Off message.

The Software

If you're going to use your PK-96 with a computer, you'll need to read parts of this section to set up your communications or terminal (modem) program software. If you'll be using your PK-96 with a dumb terminal, you won't need any software and can skip to the next section, *System Start-up and Loop-back Test*.

The PK-96 operates in much the same manner as a telephone modem, so most telephone modem terminal programs will work with your PK-96. Some of these programs are in the "public domain," which means they're free. Other terminal programs are "share-ware," which means you may get them from a friend and try them before you buy them. Of course, you can always purchase a program outright from a local amateur radio dealer, a nearby computer dealer, or through mail-order software houses.

Follow the installation directions that come with the terminal program you plan to use. Once installed on your computer, you should start the program and set its parameters to:

- Data Rate = 9600 bits per second (Baud)
- Data bits/word length = 7
- Parity = EVEN
- Stop bits = 1
- Duplex = FULL
- Handshake = XON/OFF

Whether you're using an Timewave program or not, see below for the particular type of computer you plan to use.

NOTE:

As a default, the PK-96 provides XON/XOFF software flow-control to the computer or terminal. The PK-96 command, XFLOW, can be turned off to disable software flow control and enable hardware handshake if your computer requires it. Hardware flow control is achieved with RTS/CTS (pins 4 and 5) of the DB-25 RS-232 I/O connector.

PC Compatible Computers

Although you can use almost any terminal program with your PC compatible, Timewave currently sells the *PC-Pakratt-II with FAX* and *PC-Pakratt for Windows* programs that provide many handy features not available in telephone modem programs.

If you already have either *PC-Pakratt-II with FAX* or *PC-Pakratt for Windows*, follow the instructions in the program's manual to install the software on your computer. For initial checkout of the PK-96, use the program's Dumb Terminal mode.

A partial list of PC programs tested with the PK-96 includes: ProComm, ProComm Plus, CrossTalk-XVI, Smartcom, Smartcom for Windows, Relay, BitCom, Qmodem, PC-Talk, CTerm, HamCom, PackComm, PackTalk, HamPac, LanLink, MSYS, YAPP, and the terminal program included with Microsoft Windows.

Installing PC PakRatt Lite

Timewave has included a TNC control program called PC PakRatt Lite. This is a DOS, packet-only version of our powerful PC PakRatt II. If you desire more powerful software, Timewave has it in the form of PC PakRatt II for DOS, PC PakRatt for Windows 2.0.

NOTE:

You will need 500K of free hard disk space to load PC PakRatt Lite.

1. Insert the installation disk into the floppy drive on your computer, A: or B:.
2. If you placed the disk in drive A:, type: **A:INSTPPLT** and then press ENTER.
If you placed the disk in drive B:, type: **B:INSTPPLT** and press ENTER.
This brings up a screen that explains what you need to do to install PC PakRatt Lite. Follow the directions and PC PakRatt Lite will load itself on your hard drive.
3. After installation, it is highly recommended that you print the PC PakRatt Lite Operating Manual. The manual is copied to the PC PakRatt Lite drive and the directory when the program is installed. The manual uses about 60 pages when printed. To print the manual, type: **cd\APPLITE** at the C: and press ENTER; this puts you in the PC PakRatt Lite directory. Now type: **COPY PPLITMAN.PRN LPT1** (or **LPT2**, **3**, or **4** — whichever your printer is connected to) and press ENTER. The manual should begin printing.
The manual can be viewed on your screen using a text editor, however, we recommend printing the manual on your printer.
4. After printing the manual, read through the setup instructions to find out how to properly configure the program and TNC.
5. To run the program, type: **cd\APPLITE** at the C: and press ENTER. You will see this: **C:\APPLITE>**. Now type: **PPLITE** and press ENTER.

You are now ready to setup and use PC PakRatt Lite.

Macintosh

You can use almost any Macintosh terminal program. A partial list of Macintosh programs tested with the PK-96 includes: MacRatt, Mac Terminal, Red Ryder, Microphone II, SmartComm II, and Mock Terminal.

System Start-up and Loop-back Test

Make sure that you've connected your PK-96 to an adequate power supply and to the RS-232 port of your computer or terminal.

1. *Don't* connect any other cables to your radio yet!
2. With wire strippers and radio cable in hand, remove about an inch (2.5cm) of cable jacket, exposing the five colored wires and the shield-wire. Be careful not to nick the wires' insulation.
5. Strip about 1/4 inch (7mm) of insulation from the green and white wires and short them together by gently twisting their stripped ends together.
6. Plug the cable into the RADIO socket on the PK-96's rear panel.
7. Set the TX LEVEL pot on the rear of the PK-96 to 50% rotation (straight up and down) using a small screwdriver.
8. Turn on your computer. Load your communications program. (Choose the TTY option, if available.)

NOTE:

If you're using an Timewave program, follow its manual's instructions for TNC start-up, then skip to Step 11.

9. Press the PK-96's power switch to the ON position.
10. Type an asterisk (*). The PK-96 will automatically try to recognize your computer's data (baud) rate that's set in the communications program you're using—this is referred to as the autobaud routine. When the PK-96's baud rate matches your computer's baud rate, your screen will display the following sign-on message:

```
AEA PK-96 Packet Controller
AX.25 Level 2 Version 2.0
Copyright (C) 1986-1995 by
Advanced Electronic Applications, Inc.
Release 16.AUG.95
Ver. 7.1
cmd:
```

The four red LED's on the front panel should now be off.

(Make note of the firmware release number on the first page of this manual. This is important should you ever need to call Timewave for technical support.)

"cmd:" is the PK-96's system prompt. When you enter (or have entered) a command, you'll see this prompt. *When you enter a parameter or command, type it after the prompt, press the (SPACE) bar once, enter the command's "argument" (the variable or text you're changing) if appropriate, then press (RETURN).*

11. For now, enter a mock call sign after the cmd: prompt. For example:

```
MYCALL AAA
```

After you've entered this, the PK-96 will print the following on the screen:

```
MYcall was PK96
MYcall now AAA
```

12. The PK-96 recognizes the letter "C" to mean "connect to...". Try to connect to yourself by entering:

```
C AAA
```

After a few moments, your monitor should display:

```
*** CONNECTED to AAA
```

13. Type *Hi, there!*, then press (RETURN). Your monitor should echo the same message.
14. Press (CTRL-C)—you'll get the cmd: prompt back. Enter the letter "D" so you can disconnect from yourself. You should get the message:

```
*** DISCONNECTED: AAA
cmd:
```

If you've gotten this far, the PK-96 is operating properly. If you're having difficulties, see *Chapter 7 - Troubleshooting*.

If all of the previous steps were successful, you've completed the system checkout and are ready to proceed to the next chapter. In Chapter 3, you'll connect your PK-96 to your radio and begin using it on the air.

If you experienced problems with the above procedure, go back to Step 1 *after* checking all the cables and connectors for proper wiring, continuity, and connection. Read each step again carefully. The most com-

mon errors made during this procedure are: trying to connect to a call sign different from the one you entered after MYCALL, not having the green-and-white wires shorted, or not setting the 1200 LEVEL to 50% rotation.

If you still have problems and consulting *Chapter 7 - Troubleshooting* doesn't help, leave your PK-96 on and call Timewave's Technical Support department.

3. Radio Installation

Overview

This chapter describes how to connect the PK-96 to your radio receiver or transceiver.

If You Just Want to Listen ...

If you're only interested in receiving and not transmitting signals, the audio connection to the PK-96 is simple—just plug one end of the supplied audio cables into the RX AUDIO jack in the rear of the PK-96 and the other end of the cable into the external speaker/earphone jack of your radio.

NOTE:

The PK-96 needs at least 200 mV_{p-p} for it to operate reliably.

To Transmit and Receive. . .

If you want to transmit as well as receive, you'll need to make the proper connections to your radio's speaker, microphone, ground, and the Push-To-Talk (PTT) circuits.

The best way to connect the PK-96 to your transceiver is through its rear panel accessory port (if it has one)—it will free up the mike jack so you don't have to swap connectors with your mike and the PK-96. If your radio doesn't have an accessory port, use its microphone connector for your hookup.

NOTE:

If your controller is connected to your radio's accessory port and you leave your mike plugged in, it will cause your radio to transmit whatever it hears from the PK-96 if you accidentally key the mike.

Radio Connection Requirements

NOTE:

Make sure that you remove power from your PK-96 and radio before making any of the following connections.

You'll need the following items to make a radio cable to connect the PK-96 to your transceiver:

- The Timewave-supplied radio cable.
- A microphone or accessory-plug connector.
- A schematic of your radio's microphone or accessory port.
- A low-wattage (under 40W) soldering iron and solder.
- Wire cutters or strippers.

The lines you'll be connecting from your radio to the PK-96 are:

Receive Audio: carries the audio signals from your radio's internal or external speaker jack to the PK-96. However, the audio can usually be tapped from a particular pin in your transceiver's mike connector.

Microphone Audio (AFSK): carries the transmit audio signal from the PK-96 to your transceiver for transmission.

Ground: provides an electrical return-path for the PK-96's DC (and RF) signals.

PTT: when energized—like when you press the button on your mike—it puts your transceiver into transmit.

If your transceiver has these four lines, then you shouldn't have any problem getting your radio to work with the PK-96.

Connections for Specific Transceivers

Appendix A contains notes and diagrams for connecting the PK-96 to many VHF/UHF transceivers for 1200 bps operation. Go there to locate the transceiver model(s) you will be connecting to your PK-96. At the same time, refer to your radio's Operating Manual to verify the pin assignments. (If you don't find your transceiver listed in *Appendix A*, then locate a model from the same manufacturer that has the same accessory or mike connector and pinouts as the unit you'll be connecting—usually the manufacturer is consistent with their wiring formats so the hookups will be the same.)

For radio hookups involving 9600 bps operation, see the *Radio Connection Requirements for 9600 bps Operation* section later in this chapter.

If you have any questions about your manual's wiring diagram for your radio, or there's a difference in the pin-out diagrams between your radio's manual and ours, call or write your radio's manufacturer or Timewave for assistance.

Basic Connections and Adjustments

The following table and figure will help you identify the connection points to the PK-96's radio cable.

Pin	Signal Name	Wire Color	Description
1	Microphone Audio	White	Transmit audio from the PK-96 to your transmitter
2	Ground	Brown	Audio and PTT common return
3	Push-To-Talk	Red	Keying line to your transmitter
4	Receive Audio	Green	Audio from your radio to the PK-96
5	Squelch Input	Black	Squelch input from radio (optional)
	Shield/Drain Wire	Silver	Shield of cable / Microphone ground

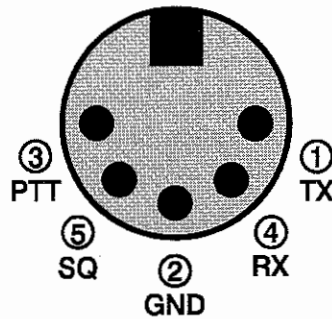

PK-96 to Radio Cable Connections

If you'll be using a packet channel that's shared with voice users, you should connect the black wire to the Squelch status pin of the connector—this will prevent the PK-96 from transmitting when there's a received signal strong enough to open the squelch. If you connect this pin, you may have to change the setting of the SQUELCH command in the PK-96. (Most VHF/UHF Packet operations are no longer shared with voice repeaters, so this connection generally isn't used.)

For example, let's say you want to hook up an Alinco DR-112T to your PK-96. Go to *Appendix A* and turn to the page listing the Alinco radios. There, the DR-112T is listed and to its right—under the Figure column—it refers you to Figure 1 and the Notes column, Note 1. Turn to Note 1. It applies because if we look at Figure 1, it shows that there's nowhere for the green wire to connect. (Use the included 3.5mm audio cable—or a shielded audio cable of your own—to carry the audio from your transceiver's external speaker/earphone jack to the RX AUDIO IN jack on the PK-96.) The brown wire, Ground, is connected to pin 8. The braided cable, shield, is connected to pin 7. The white wire, Mike Audio (AFSK), is connected to pin 1. Finally, the red wire, PTT, is connected to pin 2.

So, to fashion the radio cable:

1. Locate the radio cables included with your PK-96.
2. Prepare the bare end by removing an appropriate amount of jacket for the mike connector you'll attach. Typically, this is .5 - .75 inches (13 - 19mm).
3. Carefully remove the foil shield exposing the colored wires underneath. *Be careful not to nick or cut the shield wire.*
4. Strip back about .125 inch (7mm) of colored insulation from the red, white and brown wires. Don't strip back the black wire if you don't intend to use it—just cut it short.
5. Feed the connector's backshell over the cable end, then look at the connector closely to locate pin 1. Compare this to the location of Pin 1 on the connector drawing in your transceiver's manual and the one in *Appendix A*. This is important, as some diagrams show the connector from the inside of the transceiver, not the outside of the plug you are wiring. This will help insure that the plug is not wired backwards.
6. Warm up your soldering iron and begin soldering the wires.

NOTE:

When wiring a connector, it's often easier to wire the inside or middle pins first then work your way to the outside pins.

7. Connect the Shield (silver) wire to the mike's ground connection if your transceiver has one. If it doesn't have a separate mike or ground connection, then connect it to the single ground along with the brown wire. (See the next step.)
8. Connect the brown wire to the main ground on the connector. This ground is the one used for the PTT and receive audio. You should connect the silver Shield/Drain wire to this ground *only* if there isn't a separate mike ground as described in the previous step.

If you're connecting a handheld ("handy-talkie") transceiver to your PK-96, you'll probably need a resistor and/or capacitor to isolate this connection from the AFSK audio (check *Appendix A*).

Transceiver Adjustments

Make sure your PK-96 and radio are turned off and all the cables are correctly wired and connected.

1. Connect a dummy load to your radio and be prepared to monitor your transmissions with another nearby radio, such as a handheld transceiver.

NOTE:

If you don't have a spare receiver to use as a monitor, a "quick 'n' dirty" way to set the 1200 bps AFSK level is to turn the 1200 LEVEL pot on the back of the PK-96 halfway between its stops. If you happen to have a deviation meter, set the 1200 LEVEL's pot so the PK-96's deviation is 3 KHz, peak. (For 9600 bps operation, see that section later in this chapter.)

2. Verify that your PK-96 and FM radio are connected as shown in the following figure:

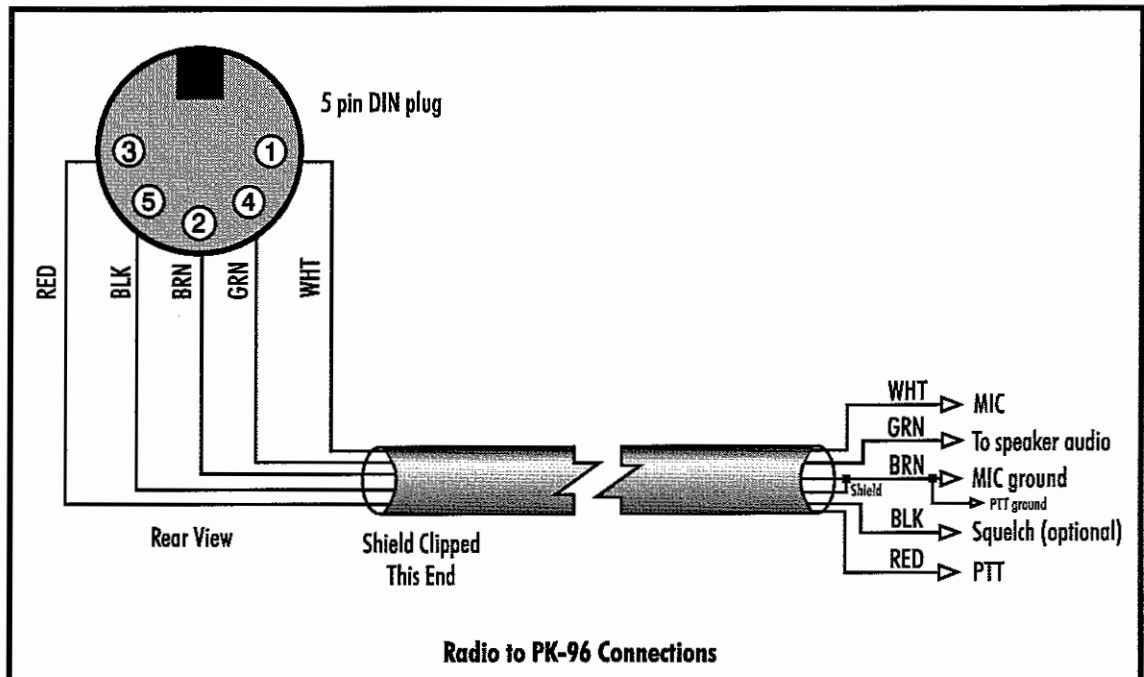

3. Turn on your radio and computer.
4. Go ahead and load your terminal program so that you're operating the PK-96 in the Dumb Terminal mode.
5. Enter the CALIBRATE mode by entering: *CAL* next to the *cmd:* prompt.

In the CALIBRATE mode *only*, the letter *K* toggles the transmitter PTT line on and off; the (SPACE) bar toggles the tone generator from Mark (the lower pitched tone) to Space (the higher pitched tone).

NOTE:

The PK-96 has a transmit watchdog timer circuit that unkeys your transmitter automatically after sixty (60) seconds.

6. Press *K* to key the transmitter. You should hear a continuous tone in the monitor.
7. Tap the (SPACE) bar several times until the higher pitched of the two tones (Space) is heard.
8. Adjust the transmit audio level as follows:
 - a) Set the monitor receiver to your transmitter's frequency and turn up the volume. Turn the PK-96's rear-panel 1200 LEVEL pot clockwise until you hear no increase in the audio output level from the monitoring receiver.
 - b) Rotate the 1200 LEVEL pot counterclockwise until the audio signal on the monitoring receiver is slightly, but noticeably, reduced.
9. Press *K* to return to receive mode.
10. Press *Q* to leave the CALIBRATE mode.
11. With your radio in the receive mode, set its squelch control "open" so that a steady hash or "white noise" is heard from its speaker.
12. Reset your receiver's squelch control for normal voice operation.

Radio Connection Requirements for 9600 bps Operation

Most VHF and UHF FM transceivers are primarily designed for voice operation and require special connections for high speed data use. Following this is a list of radio connection information for a few selected VHF and UHF FM transceivers that have been suggested or successfully used for 9600 bps packet. Take a few minutes to read this section before operating the 9600 bps modem.

Adjusting the PK-96's Deviation

With 9600 bps signals, we strongly recommend that a deviation meter be used to verify the proper level, which typically has a peak reading of 2.4 KHz. (Make sure that the deviation meter used can be set to accept modulation frequencies of at least 10 KHz like Timewave's DM-1 Deviation Meter.) If the deviation is set too low, other amateurs will not hear your signal; if set too high, your over deviated signals will interfere with amateurs operating on nearby frequencies and you won't be able to reliably communicate. Timewave manufactures the DM-1 Deviation Meter for transmitters operating in the 144, 220, and 440 MHz. bands.

Radio Connections

Except for one or two exceptions, you can't connect the transmit section of a 9600 bps modem directly to the microphone jack of your FM transmitter—the microphone connection is designed for audio and won't pass the 9600 bps data signal from the TNC. For the same reason, you can't connect the receive section of a 9600 bps modem directly to the speaker output of an FM receiver; the transmit audio (TXA) output signal from your TNC *must* be directly connected to the modulator stage of your FM transmitter. The receive section of the TNC must be directly connected to the discriminator of your FM receiver.

Presently, most FM transceivers don't have the aforementioned connections available to high-speed controllers. This is starting to change and radio manufacturers are beginning to make these connections avail-

able to the outside world. In particular, the TEKK: KS-900, Kantronics DVR 2-2 and DVR 4-10, and the Yaesu FT-5100 are 9600 bps-connectable right out of the box.

Fortunately, it's usually not difficult to locate the connections needed for 9600 bps operation in most modern FM transceivers. We'd like to thank Mike Curtis, WD6EHR, for compiling this list and for the 9600 bps connection information that follows.

Radios that are known to work at 9600 bps are:

Alinco	DR-1200, DR-110, DR-112, DR-112T, ALR-72, ALR 709
GE	MASTR II VHF with PLL exciter, MVP VHF/UHF
Icom	IC- 22, 25, 27, 28, 38, 228, 271, 275, 290, 3200, 471, 475
Kantronics	DVR 2-2, 4-10
Kenwood	TM- 211, 212, 221, 231, 431, 621, 721, 731 TR- 7500, 7700 TS- 700, 770, 790
Motorola	MICOR UHF, MITREK
Standard	C58, C140
TEKK	KS-900
Yaesu	FT- 212, 221, 230, 736

Some radios—such as the ICOM 228 & 229—have IF filters that are too narrow to successfully pass 9600 bps receive data. In this case, you can either use a different radio or install a wider filter. MuRata-Erie (2200 Lake Park Drive, Smyrna GA 30080) makes ceramic filters—the SF series is designed for data communication. If the filter is physically and electrically compatible with the existing filter in the transceiver, the SFH450D is recommended.

Yaesu USA also makes available IF filters. Presently, they sell the following filters:

<u>Filter</u>	<u>MuRata-Erie</u>	<u>Yaesu</u>
<u>Bandwidth</u>	<u>Part Number</u>	<u>Part Number</u>
15 KHz	LF-H15S	H3900204
15 KHz	CFW-455E	H3900200
20 KHz	LF-H20S	H3900205
20 KHz	CFW-455D	H3900203
30 KHz	CFW-455B	H3900201

Many modern rigs are true FM, so it's relatively simple to add a 9600 bps port—you need only a couple of internal connections and decoupling components to bring out the “raw” FM of the transceiver: the direct detector output and direct FM modulator input.

Most modern rigs use receiver chips such as the TA7761F/P, LA5006M, LC7532M, TK10420, TK10424, MC3357P, and others.

NOTE:

All of the chips mentioned here use pin 9 for the detector output—others may or may not, so check first!

Other Radios

Transmit audio is injected through a 5 to 10mF, non-polarized capacitor through a 5KW resistor into the modulator. This is typically a varactor diode in a transmit oscillator stage.

The schematic symbol for a varactor diode is , which makes them pretty simple to find by tracing forward in the radio's schematic from the microphone.

Crystal-Controlled FM Transceivers

NOTE:

True FM multimode radios using varactor modulation in a crystal oscillator stage seem to work best—they tend to have a slightly wider IF filter (i.e., the CFW455E) and pass data with less distortion. (Fortunately, most synthesized radios can be made to work with extremely simple mods.) However, if your radio is crystal controlled, it can be made to work if it uses true FM: it's simply a matter of connecting directly to the FM modulator—which will always be in a crystal oscillator stage.

If your crystal-controlled rig is true FM (varactor modulator in an oscillator stage), inject transmit audio from the PK-96 into the cathode of the varactor diode. However, many crystal-controlled rigs are phase modulated and need a varactor modulator added to the transmit crystal oscillator.

Use an abrupt junction type varactor diode, such as the MV2105 from Motorola, and adjust the capacitance in the crystal circuit to compensate for the additional capacitance of the varactor. If there are fixed-value capacitors, remove or "pad" them. If not, change the trimmer to one of a lower minimum value.

You'll need to bias the varactor. I've used the transmit oscillator V_{cc} and a 20KW trimpot to ground, feeding bias through two 10KW to 47KW fixed resistors, feeding the TNC's transmit audio through a 5mF to 10mF capacitor to the center junction of these, and feeding the free end to the cathode of the varactor. The bias needs to be adjusted for best received eye pattern on a service monitor or receiver. See the following diagram:

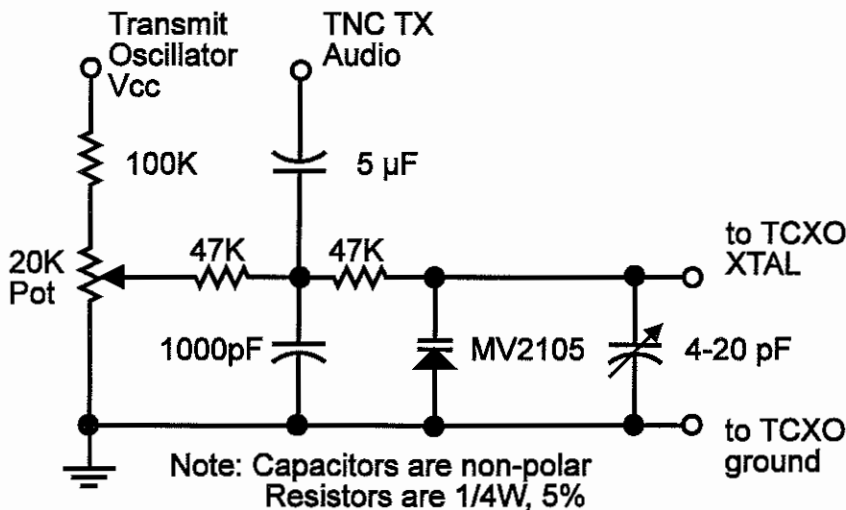

“Mod” Notes for Specific Radios

It's almost embarrassing to call some of these “mods”—you're only bringing out terminations of existing signals; bringing out these connections from your FM transceiver is a “nondestructive” modification to your transceiver, except for the ALINCO DR-1200 and the ICOM IC-22A modifications—these radios will be dedicated to 9600 bps data radios after their modifications are performed.

ALINCO DR-110, DR-112, DR-1200

This mod uses the microphone jack for both 9600 bps transmit and receive. As you read in the preceding paragraph about the DR-1200, after the mod you won't be able to transmit FM voice, but you'll still be able to receive FM voice.

Receive: Disconnect the pink wire that goes to the DATA OUT pin of the mic connector on the circuit board, then reconnect it to pin-2 of the IF board's connector. This connects the received audio from the mic plug to the radio's discriminator.

Transmit: Remove resistor R31 on the main board—this is a chip resistor located on the solder side of the main PC board. (Note: if you de-solder the part and resolder it so that only one edge of it is still connected to the board, you can more easily return the radio to 1200 bps—and FM voice—operation if needed.) Remove chip capacitor C40, then resolder it to the circuit board so that one end of the capacitor is connected to the pin-7 of the VCO board and the other end is straight up in the air. Connect a jumper wire between the free end of C40 and the “hot” end—the end not grounded, or the end electrically furthest away from ground—of C35. (Note that C35 is next to the resistor R31 you removed earlier.) The mic input is now connected to the VCO for 9600 bps operation.

GE Phoenix and GE PSX-200 (courtesy of William N. Goodman, K3ANS and K3HKZ)

These radios have a Data In jack, J-301. It is next to the data level control, R-212, midway on the right side of the radio looking with the top up, from the front of the radio. Run a thin 22 guage wire from J-301 to pin 5 of J-911 on the back. Remove the W-910 jumper from hole 85 to hole 86. This removes the mike high input through the mike audio preamplifier. This enables the radio to work with 9600 bps.

ICOM 22A (courtesy of Mike Curtis, WD6EHR and Dave Shalita, W6MIK)

This is one of the more difficult rigs to modify. It converts your IC22A into a dedicated 9600 bps packet radio. Components with an asterisk are added to the crystal board.

1. Remove the trimmer capacitor for the transmit crystal socket you'll be using for 9600 bps. Replace with the above circuit. The 4pF-20 pF trimcap should be a good quality ceramic or other low-drift trimmer. (Sorry, Radio Shack doesn't have anything suitable.)
2. Connect two 10K Ω resistors to C53 (both sides) and tie the other ends together. This junction is where you'll pick off your receive audio.
3. Turn R67 (deviation control next to P-1 and P-2) fully counterclockwise—this kills any signals that may get into the phase modulator.
4. Using a service monitor, or oscilloscope connected to the detector of a receiver, adjust the varactor bias for the best eye pattern.

ICOM IC290A/H

Receive audio may be obtained at IC12, pin 9, on the main board. Transmit audio can be injected at D3's cathode on the main board. If you still have the mating ACC connector plug, connections can be added to it.

ICOM IC28A/E/H

Receive audio may be obtained from IC1, pin 9, on the RF unit. Transmit audio may be injected at R-45, at the end *not* connected to trimpot R-100. Use a 33K Ω resistor in series to correct signal levels.

ICOM IC3200A/E

Receive audio may be obtained at IC1 pin 9 (main board)—this is a common receiver chip for both bands. Transmit audio may be injected at D3's cathode (VHF) and D1's cathode (UHF).

KENWOOD TM221, TM321A, TM421

Receive audio may be obtained at IC1, pin 9 (IF board). Transmit audio may be injected at connection #7 on the VCO assembly on the TX/RX unit.

KENWOOD TM621, 631 and 721 (courtesy of Jeff Angus, WA6FWI)

Receive audio is taken from the discriminator output. Look for the 3.3K Ω resistor coming off pin 9 of the last IF stage. Connect a 1K Ω series resistor from the modem RX input to the junction of the .001mF capacitor and the 3.3K Ω resistor.

PTT is taken from pin 2 on the microphone connector. Transmit audio is fed through a 1K Ω series resistor to the top of VR3 (the deviation control).

NOTE:

This method has been tested and works quite well on 440 MHz and 220 MHz. The mods haven't fully been tested on the 2-meter portion of the radio.

As with any modifications, take reasonable care—the radio is full of surface mount components.

KENWOOD TR751

Receive audio may be obtained at IC2, pin 9 on the RX unit. Transmit audio may be injected by way of the cathode D21.

KENWOOD TS-790 (courtesy James Miller, G3RUH & Suelo Asato, JA6FTL)

These mods work well with 9600 bps UO-14 and CBBS operation. (Refer to G3RUH's notification on FT736R for more details. RX/TX mod suitability remains the same as his notes.)

Receive: Detected and amplified/buffered FM direct from the receiver discriminator is available from Pin 9, IC1 (Sub) or IC8 (Main). I use IC1 (Sub) for reception.

Transmit: Inject your transmit audio at the cathode side of diode D81 with a 1K Ω resistor in series. (You can find D81 near Q73 in your IF UNIT diagram.)

KENWOOD TW-4000 (courtesy of Mike Curtis, WD6EHR)

The radio's filters look good, although digitally optimized filters such as MuRata SFG-455D or SFH-455D would allow a tighter passband. The radio also uses a separate transmit oscillator common to both 144 and 430 MHz for generating FM—a crystal, inductor, and a varactor to produce nice, linear FM—and heterodynes up from there to the respective bands.

The mods for transmit audio and receive audio are:

Receive: Tack a 4.7K Ω resistor to IC-1, pin 17. **Transmit:** tack a 6.8K Ω resistor to the cathode of D16 (junction of C125-R95-D16).

If the received eye pattern from a known good transmitter is jittery, try changing C155 (associated with Q19) from .01mF to something like .005mF to .001mF. It also might be necessary to change C125 from .0022mF to .001mF if the transmit waveform is jittery.

MOTOROLA MICOR (courtesy of Dan Meredith, N7MRP)

The MICOR was modified for stand-alone operation (without a control head). On P901 (the big connector in the front), pin 11 is jumpered to pin 1 (Ground), pins 8, 3 & 22 are connected together and to a 2A fuse connected to the big A+ feed through going into the PA. All these jumpers are done on the control (inter-connect) board, except for mounting the fuse itself. Unless you want to listen to speaker audio, there's no need to install volume or squelch pots; the audio amps are not used in this application.

We performed a few mods that seemed to help prevent problems: add a capacitor (at least 20mF—I use 220mF) across C903 on the control board (this is the tubular electrolytic located just to the rear of the 9.6V regulator transistor heatsink), and add a diode (1N4001 or better) from P901 pin 16 to any of the A+ pins (3, 8, 18) with the banded end to the A+ pin. (This is a “spike” suppression diode.)

On the Audio/Squelch board, replace C203 with a 1mF to 10mF electrolytic/tantalum. I recommend at least a 20V rating—this improves the low frequency end of the discriminator's audio.

If your radio has a CTCSS encode board plugged into the exciter, remove it. Install JU304, which is located immediately adjacent to the encoder board connection on the exciter. Depending on which exciter you have, the encoder will have either 7 or 11 pins—in either case, the pin you will use to inject transmit audio is the one adjacent to the big square hole towards the outside edge of the radio (pin 6 for 7-pin, or pin 10 for 11-pin ones). Connect a shielded lead from this pin to an unused pin on P901 (I use pin 27). On the exciter, trace the land from the pin you just connected to and you will find an 82KW resistor—replace it with a 10KW resistor (1/4W, 5%) and a 10mF capacitor in series. (Some exciters already have a 6.8mF capacitor in series—if you are *sure* yours has the capacitor, you don't need to add another!)

On the receiver RF/IF board, remove the two crystal filter “cans” that come after the IF amp IC (Y103 and Y104), and replace them with 1000pF disc capacitors (value not critical). Note that the caps *don't* connect to the center ground pin. (This mod is crucial to making the receiver work at 9600.)

Connect the transmit audio to whichever pin you connected the jumper to; receive audio (discriminator) is on pin 20, PTT is pin 16, and 12V goes to the two big pins in the middle (pins A and B).

It is advisable to obtain a service manual for these radios if you plan on using them—it's Motorola part #68P81015E70, and you should be able to order one through any Motorola service shop.

MOTOROLA MITREK (courtesy of Jim Wooddell, WA6OFT)

The Motorola Mitrek is one of the best radios to use for general amateur packet at 9600 bps. This mod will allow 9600 bps packet with the G3RUH type of modems, although other modems may work as well.

1. Locate the transmit audio amp/splatter section on the transmitter section of the schematic, then locate the Active Splatter filter.

NOTE:

The last transistor, Q504 on the VHF version, may have a different number for the other frequency bands.

2. Locate the transmit channel elements and pin 4 on channel element #1 and the line going to pin 4 of element #1 to the collector of Q504. This is the direct FM modulator input. Cut this trace at the channel element.
3. Solder one side of the 1mF electrolytic cap to pin 4 of the channel element. The other side of the cap is now the modulation input from your modem or TNC. Run it into the radio using shielded wire.

4. Install a .1mF capacitor between pin 3 and pin 1 of the channel element.
5. Locate pin 11 on J1—this is the plug on the front of the radio. Make your receive audio connection there. You shouldn't need to make any mods to the receiver. (If you don't have any real good test equipment, don't make any receiver mods—it will work okay.)
6. Install a .1mF capacitor between pins 1 and 3 on receiver channel element.

NOTE:

At first, set your TNC's TXD argument to 200mS. If all works well, start lowering the TXD value—you'll probably end up with a TXD of 7, or 70mS. The capacitors on the channel elements' pins really don't affect 9600 bps operation, but they do reduce the local oscillator leak that emits out of these radios which is about 20 dB (very important on hilltops).

TEKK KS-900

For the TEKK KS-900, the needed transmit level is in the 50 mV range; the level adjust is fairly sensitive in this range, so it may be desirable to use a resistive divider to reduce the level from the 9600 bps modem board. This is simply a 470 Ω resistor in series and a 39 Ω resistor across the TEKK's transmit input and ground.

YAESU FT-211-RH (courtesy of Chris Lorek from SMC)

The FT-211RH has been shown to be suitable for 9600 bps packet operation. Just two shielded leads are required, one for receive audio and the other for transmitter audio. They are connected as follows:

Receive: On the RX IF Unit (sub board F2869104), connect the shielded inner conductor to the TK10420 IC, pin 9, with the shielded wire to pin 15. Caution should be taken to solder these if they are to be soldered to the underside of the board.

Transmit: On the rear of the main PCB is a small potentiometer—this is the peak deviation adjustment pot. Unsolder the leg nearest to the rear of the set, then connect the inner conductor of the shielded TX leads to this point and the outer shield to the circuit board's ground plane adjacent to this point. To ensure that the 9600 bps modem is terminated with the required impedance, it's essential that a suitable terminating resistor be placed across the shielded lead inner/outer (such as a 560 Ω resistor); this can be done at the FT-211RH's potentiometer connection.

YAESU FT-726 (courtesy of Rick Meuse, N1HID)

Tap off between R45 and R96 for the receive, and between R22 and C16 for the transmit end. You'll have to change the receive filter to a wider one (CFW-455D) which I haven't done yet.

YAESU FT-736 (courtesy of James Miller, G3RUH)

These notes tell you where to get at the FM receive audio direct from the discriminator and where to modulate the FM TX varactor directly. These mods are nondestructive and take no more than a few minutes. The signals bypass the "DATA" socket for high-grade FM operation.

The receive mod is suitable for:

- UOSAT-D 9600 bps downlink and terrestrial links
- 1200 bps AFSK/FM standard packet

The transmit mod is suitable for:

- FO-20/PACSAT uplink (1200 bps Manchester FM)
- UOSAT-D 9600 bps uplink direct FSK and terrestrial links
- 1200 bps AFSK/FM standard packet

Receive: Detected FM direct from the receiver discriminator is available from the RX UNIT at the junction of R91 and C83. These components are shown in the top, right-hand corner of the schematic.

Proceed as follows:

1. Disconnect power and all cables from the FT736 for safety.
2. Remove the top cover *only*.
3. The RX unit is the vertical module on the left.
4. Locate R91 which is about 25mm from the top, and 50mm from the rear of the radio; the resistor is "on-end" and near a couple of glass diodes.
5. Scrape any paint off R91's free end and wet with solder.
6. Your RX audio lead should be a fine, shielded cable (such as RG-174); connect the inner conductor to R91 and the outer shield wire to a ground point (e.g., "can" of TO-09).
7. Route the cable out through any convenient opening in the case.
8. The discriminator sensitivity (FM Normal) is about 6 KHz/volt.

NOTE:

Some FT736 receivers are fitted with an LFH12-S IF filter for FM. (CF01 at the top front of the RX Unit.) This is a 12 KHz bandwidth filter which is a little narrow for 9600 bps operation. It's recommended you change this to 15 KHz, or better still for UOSAT-D use, a 20 KHz bandwidth which will allow more tolerance for Doppler shift and gives a far better "eye." Suitable filters are: LFH-15S or CFW455E, and LFH-20S or CFW455D. The first set of these is a Yaesu spare part and is often already fitted. Try the standard first and see what happens—these filters have moderate part to part variations.

Transmit: Inject transmit audio at the junction of R32 and C29 on the TX Unit. The signal level at this point should be 800 mV_{pp} and will give ± 3 KHz deviation—*don't exceed this level*. Set the Mic gain on the front panel to its minimum setting.

Proceed as follows:

1. Disconnect power and all cables from the FT736 for safety.
2. Remove the top cover *only*.
3. The TX Unit is the module flat on the left (*not* the one tucked down the side vertically).
4. R32 is just to the left of the rectangular shielded enclosure. The resistor is "on end." Scrape off any paint from the free leg and wet with solder.
5. The transmit audio lead should be a fine, shielded cable (such as RG-174); connect the inner conductor to R32 and the outer braid to the adjacent enclosure.
6. Route the cable out through any convenient opening in the case.
7. 9600 bps FSK modem: Adjust transmit audio level with VR-1.

Packet Parameters

The AX.25 parameters we all know and love at 1200 bps don't work very well at 9600 bps. These are what we've found work well at 9600:

TXDelay	Set between 8 and 15 for best throughput.
RESptime	100mS seems to have better results than 0.
FRack	8 seconds on a busy channel; but never less than 5 seconds.

PERSIST 128 , users; if it's a pretty clean channel, 64 is nice; if it's busy, estimate the average number of users and divide 128 by this number. For example, for 4 users: $128 \div 4 =$ PERSIST 32.

SLOTTIME 20

MAXFrame If the channel is great: 7; average: 3; rough: 1.

RETry 15

CHeck 30 (300 seconds)

4. You're in Command

Overview

We know you're chomping at the bit to get on-the-air, but before you do you should familiarize yourself with the PK-96's "operating system," a few important commands, and its list of available commands.

Most of the commands have a standard (default) value that provides good performance for the average amateur radio station, but there's no rule that says you must keep these defaults. You can—and should—change the default values as required for your individual operating needs, type of equipment, and local operating practices or protocols.

Don't be intimidated by all the commands that are available to you—an average user needs to understand or change only a handful of them. Once set, they usually don't need to be reckoned with again. (See **EXPERT**.) This chapter is intended as a command and error message reference and is *not* meant to be read from start to finish. However, you might want to peruse the chapter and make a list of commands you think you'll need to use.

Parameters and Arguments

If a command requires an argument, the type of argument is indicated after the command name as well as its default value. There are three different types of parameters used: Boolean, Numeric (or Text), and String.

Boolean

Boolean arguments use one value out of a choice of only two possible values, such as *ON* or *OFF*, *YES* or *NO*, or *EVERY* or *AFTER*. Boolean arguments can also be changed back and forth (toggled) with an argument of *TOGGLE* or *T*.

Numeric

An argument designated as "*n*" is a numeric value. Numeric values can be entered by typing them in familiar decimal numbers, or in hexadecimal numbers. When using hexadecimal notation, you must type a \$ in front of the number to tell the PK-96 that this is a "hex" number.

For numeric parameters, the arguments *ON* or *Y* set the parameter value to its default. Arguments *OFF* or *N* set the value to zero. Baud-rate parameters can use arguments *UP* (*U*) or *DOWN* (*D*) to select the next higher or lower baud rate.

Text or String Arguments

A text parameter, such as the **CTEXT** message, can hold almost any ASCII character, including uppercase and lowercase letters, numbers, spaces, and punctuation.

Some commands, such as **CONNECT**, require call signs as arguments. These arguments are usually call signs, but may be any string of up to six characters with at least one letter. Some commands, such as **CFROM**, have arguments which are actually lists of call signs. You must separate multiple call signs with either spaces or commas.

Changing Commands

As you skim through the list of commands, you'll notice that the first few characters in the command are capitalized and the rest aren't. The capitalized letters are a shorthand way of entering a command and are the minimum number of characters you need to type in to use that command. For example, with the command DISPlay, you can enter DISP, DISPL, DISPLA and DISPLAY and all these entries will work. You can also enter commands using lowercase, uppercase, or a combination of lowercase and uppercase letters. Most people find it preferable to enter their commands in lowercase, but for emphasis the commands in this manual are printed uppercase.

IMPORTANT:

Between the cmd: prompt and the command(s) you enter, you must insert a space using the (SPACE BAR) on your computer keyboard.

When you change a command's value, the PK-96 will let you know a change has been made and the change will be automatically saved. Say you want to enter your call sign. You'd enter your call sign after the cmd: prompt by typing MYCALL *call*. If your call sign is WF7A, then this is what you'll type:

```
cmd: MY WF7A
MYcall: was PK96
MYcall: now WF7A
cmd:
```

If you turn off or remove the power cord from your PK-96, it will remember the change(s) you've made provided you haven't removed the PK-96's internal jumper, JP-1. Also, all commands that accept values or parameters may be typed without any arguments to check their present setting.

If, while blissfully changing timing commands and such, you find that you've "dug yourself into a hole" and the PK-96 doesn't work as well as it did before, enter REINIT—it will reinitialize most of the commands to their default settings and perform a RESTART, but it *won't* lose the contents of the MailDrop. (Contrary to this, if you enter RESET, you'll return the PK-96 back to its factory default settings, lose any stored mail messages, and you'll have to go through the autobaud routine again.)

List of Commands

Commands are listed alphabetically with their descriptions. Each command entry contains several fields of information: Command Name, Default Value, Mode(s) in which the command is used, Host mode abbreviation (for Host mode programmers) and operational description. The default value is listed first.

Host Mode Abbreviations

If you're a programmer and want to write an application for the PK-96, you need to use the Host Mode. Information on Host Mode is available in the *Technical Reference Manual—Model PK-232 Data Controller*.

3RDparty ON/OFF	Default: OFF
Mode: MailDrop	Host: 3R
OFF The MailDrop will only handle mail sent directly to, or from, you. (See MYCALL and MYMAIL.)	
ON The MailDrop will allow third party mail delivery and forwarding.	

With 3RDPARTY ON, stations can leave messages in your mailbox addressed to you or someone else.

8Bitconv *ON/OFF* Default: OFF
 Mode: packet Host: 8B

- OFF The high-order bit is stripped in Converse Mode.
- ON The high-order bit *isn't* stripped in Converse Mode.

8BITCONV permits transmission of 8-bit data in Converse mode. When 8BITCONV is *OFF*, the high-order bit (bit 7) of characters received from the terminal is set to 0 (zero) before the characters are transmitted.

ACKprior *ON/OFF* Default: OFF
 Mode: packet Host: AN

- OFF* This feature is disabled.
- ON* Priority acknowledgment is enabled.

This command implements the Priority acknowledge scheme described by Eric Gustafson, N7CL, which proposes to improve multiple-access packet performance on HF and VHF simplex channels with "hidden" terminals. When a busy channel clears, the acknowledgments are sent immediately, while data and poll bits are held off long enough to prevent collisions with the *ack* packets. By giving priority to data *acks*, fewer *acks* will collide with other station's data, reducing retries. Digipeated frames are sent immediately. RAWHDLC and KISS force ACKPRIOR *OFF*.

These are the defaults for a P-persistence system with no Priority acknowledgment: ACKPRIOR *OFF*, PPERSIST *ON*, PERSIST *63*, SLOTTIME *30*, RESPTIME *0*, MAXFRAME *4*, and FRACK *5*.

The following are the recommended command settings for Priority acknowledge:

```
1200 bps VHF packet
ACKPRIOR ON
PPERSIST ON
PERSIST 84
SLOTTIME 30
RESPTIME 0
MAXFRAME 1 - 7
FRACK 8
HBAUD 1200
DWAIT - doesn't matter
```

Stations using neither the Priority acknowledge nor the P-persistence schemes should set DWAIT *73* for 1200 bps and DWAIT *2* or *3* for 9600 bps work. Stations using P-persistence, but not Priority acknowledge should set PERSIST and SLOTTIME to the same values that ACKPRIOR stations are using.

Timewave and TAPR use some different command names to handle P-persistence. The following table should help with the Timewave/TAPR command differences:

TAPR Slots	MFJ SLOTMASK	Timewave PERSIST	Remarks
1	\$00	255	Disables slotting
2	\$01	127	
3		84	
4	\$03	63	Default setting
6		42	

8	\$07	31	Very busy channel
12		20	
16	\$0F	15	Extremely busy channel
64	\$3F	3	

Timewave products calculate the TAPR ACKTIME value based on the setting of HBAUD. The TAPR DEADTIME command is similar to Timewave's SLOTTIME command.

ACRDisp *n* Default: 0
 Mode: packet Host: AA
 “*n*” 0 to 255 specifies the screen width, in columns or characters.
 0 Disables this function.

The numerical value “*n*” sets the terminal output format for your needs. The PK-96 sends a (RETURN) + (LF) sequence to your computer at the end of a line in the Command or Converse modes, when “*n*” characters have been printed on the computer screen. Most computers and terminals do this automatically, so ACRDISP defaults to 0.

ACRPACK *ON|OFF* Default: ON
 Mode: packet Host: AK
ON The SENDPAC character is added to packets sent in Converse mode.
OFF The SENDPAC character *isn't* added to the packets.

With ACRPACK *ON*, all packets sent in the Converse mode include the SENDPAC character, normally a (RETURN), as the last character of the packet.

When ACRPACK is *OFF*, the SENDPAC character is interpreted as a command, and isn't included in the packet or echoed to the terminal.

ACRPACK *ON* and SENDPAC *\$0D* produce a natural conversational mode.

Address *n* Default: \$0000
 Mode: packet Host: AE
 “*n*” 0 to 65,535 (\$0 to \$FFFF) setting an address in the PK-96's memory.

ADDRESS sets an address somewhere in the PK-96's memory map and is usually used with the IO, MEMORY, and other PK-96 commands. It's used primarily by programmers and is of little use without the *PK-232MBX Technical Manual*.

AFilter *ON|OFF* Default: OFF
 Mode: packet Host: AZ
OFF The ASCII characters in the MFILTER list are filtered from monitored packets only.
ON The ASCII characters in the MFILTER list are filtered out and not transmitted.

Some terminals and computers use special characters to clear the screen or perform other “special” functions. Placing these characters in the MFILTER list, and turning AFILTER *ON*, will keep the PK-96 from transmitting them.

Exception: when ECHO is *ON* and the computer sends a filtered character, the PK-96 will echo it back to your terminal or computer.

AFILTER works regardless of mode, or CONNECT/CONVERSE/TRANSPARENT status. Leave AFILTER *OFF* during binary file transfers.

ALFDisp *ON|OFF*

Default: ON

Mode: packet

Host: AI

ON A line feed is sent to the terminal after each (RETURN).

OFF A line feed *isn't* sent to the terminal after each (RETURN).

ALFDISP controls the display of (RETURN) characters received, as well as the echoing of those that are typed in.

With ALFDISP *ON*, the PK-96 adds a line feed (LF) to each (RETURN) it receives, *if needed*. If a LF was received immediately before or after a (RETURN), ALFDISP won't add another LF. Use the PK-96's sign-on message to determine how (RETURN)'s are being displayed. (ALFDISP affects your display, *not* transmitted data.)

- Turn ALFDISP *ON* if the PK-96's sign-on message lines are typed over each other.
- Turn ALFDISP *OFF* if the PK-96's sign-on message is double spaced.
- ALFDISP is set correctly if the PK-96's sign-on message is single spaced.

ALFPack *ON|OFF*

Default: OFF

Mode: packet

Host: AP

OFF A line feed isn't added to outgoing packets (default).

ON A line feed *is* added after each (RETURN) sent in outgoing packets.

ALFPACK is similar to ALFDISP, except that the LF characters are added to outgoing packets rather than to text displayed on your computer screen. If the person you're talking to reports overprinting of packets from your station, set ALFPACK *ON*.

ALFPACK is disabled in the Transparent mode.

AUdelay *n*

Default: 2 (20 mS)

Mode: packet

Host: AQ

"*n*" 0 - 120 specifies in units of 10 mS intervals, the delay between PTT going active and the start of the transmit AFSK audio tones.

In some applications you may need to make a time delay from the moment the radio PTT line is keyed and the time that audio is produced from the PK-96. Most notably, on HF when an amplifier is used, arcing of the amplifier's relay contacts may occur if drive to the amplifier is applied before the contacts have closed. If arcing occurs, increase AUDELAY slowly until the arcing stops.

In VHF or UHF FM operation, some synthesized transceivers may produce undesirable spurious emissions if audio and PTT are applied at the same time. These emissions may be reduced by setting AUDELAY to roughly half of TXDELAY.

Please note that AUDELAY must *always* be less than TXDELAY. It's advisable that AUDELAY be set lower than TXDELAY by a setting of 10. For example, you've determined that TXDELAY 20 works well

for your transceiver. Subtracting 10 from 20 yields 10, which is the recommended setting for AUDELAY. If a setting of AUDELAY 10 is too short, then set *both* TXDELAY and AUDELAY higher.

AUTOBaud *ON|OFF* Default: OFF
 Mode: Command Host: AB

OFF Autobaud routine active at power-up *only* if battery jumper is removed.

ON Autobaud routine always present at power-up or RESTART.

With AUTOBAUD *OFF*, the PK-96 performs the autobaud function only when powering-up or after a RESET. With AUTOBAUD *ON*, the PK-96 performs the autobaud routine *every* time it's powered-up, and *every* time the RESTART command is entered. The stored parameters (for example, MYCALL) are saved if the battery jumper is connected. The unit displays the autobaud message at the same rate as the last setting of TBAUD. AUTOBAUD *ON* is helpful when moving the unit from one computer to another where the terminal data rates are different.

In the autobaud routine, only one asterisk (*) is needed to set TBAUD. The autobaud routine detects 110, 300, 600, 1200, 2400, 4800 and 9600 bps at either 7 bits, even parity or 8 bits, no parity.

AWLen *n* Default: 7
 Mode: packet Host: AW

"*n*" 7 or 8 specifies the number of data bits per word.

The parameter value defines the digital word length used by the serial input/output (I/O) terminal port and your computer or terminal program.

AWLEN will most likely be set properly by the PK-96's autobaud routine. Still, you may want to change the ASCII word-length at some time to accommodate a particular terminal program you want to use.

For plain text conversations with the PK-96, AWLEN 7 or 8 may be used. For binary file transfers and Host mode operation, AWLEN 8 *must* be used.

The RESTART command must be issued before a change in word length takes effect. *Don't* change AWLEN unless the terminal can be changed to the same setting.

Ax25|2v2 *ON|OFF* Default: ON
 Mode: packet Host: AV

ON The PK-96 uses AX.25 Level 2 Version 2.0 protocol.

OFF The PK-96 uses AX.25 Level 2 Version 1.0 protocol.

This command allows the selection of either the old (version 1) version of the AX.25 packet protocol or the current (version 2.0) protocol. Some implementations of version 1 of AX.25 protocol won't properly digipeat version 2.0 AX.25 packets. Most users run AX.25 version 2, but this command allows you to return to the older version, if necessary, for compatibility.

AXDelay *n* Default: 0 (00 mS)
 Mode: packet Host: AX

"*n*" 0 to 180 specifies a key-up delay for voice repeater operation in 10mS intervals.

AXDELAY specifies the period of time the PK-96 will wait—in addition to the delay set by TXDELAY—after keying the transmitter and before data is sent. Packet groups using a standard voice repeater to extend the range of the local area network may need to use this feature.

Repeaters with slow electromechanical relays, auxiliary links, or other circuits which delay transmission after the RF carrier is present require more time to get RF on the air. Try various values to find the best value for “*n*” if you’re using a repeater that hasn’t been used for packet operations before. If other packet stations have been using the repeater, check with them for the proper setting. AXDELAY acts together with AXHANG.

AXHang *n* Default: 0 (000 mS)

Mode: packet Host: AH

“*n*” 0 to 20 specifies voice repeater “hang time” in 100 mS intervals.

AXHANG allows you to increase efficiency when sending packets through a repeater that has a hang time greater than 100mS. When the PK-96 hears a packet sent within the AXHANG period, it doesn’t add the repeater key-up delay (AXDELAY) to the key-up time. Try various values to find the best value if you’re using a repeater that hasn’t been used for packet operations before. If other packet stations have been using the repeater, check with them for the proper setting.

BBSmsgs *ON|OFF* Default: OFF

ON - Makes the PK-96 status message look like TAPR-style output.

OFF - The PK-96 status message will work as before (default).

When BBSMSGs is ON, some of the status messages change or are suppressed which may improve operation of the PK-96 with some BBS software. The following Timewave PK-96 status messages are suppressed or changed if BBSMSGs is ON:

No “(parm) was (value)”

No “(parm) now (value)”

Connect messages: No “; v2; 1 unACKed”

No “xxx in progress: (dest) via (digis)”

No space after comma in digipeater lists

“Via” in upper case

If MRPT is ON, digi paths are displayed in TAPR format

No “*** connect request:”

No “*** retry count exceeded”

Sends carriage return before all other “***”

No “(callsign) busy” message

Beacon *EVERY|AFTER n* Default: *EVERY 0* (00 sec.)

Mode: packet Host: BE

EVERY Sends a beacon at regular intervals.

AFTER Sends a beacon after the specified time interval without any packet activity.

“*n*” 0 to 250 sets beacon timing in 10-second intervals.

0 Zero turns off the beacon (default).

The **BEACON** command sets the conditions under which your beacon will be sent. A beacon frame contains the text that you've typed into the **BTEXT** message slot in a packet addressed to the **UNPROTO** address. When the argument **EVERY** is specified, a beacon packet is sent every "*n*" x 10 seconds. When **AFTER** is specified, a beacon is sent *after* (*n* x 10) seconds have passed without any packet activity being heard.

If you set the **BEACON** timing less than **90**—a value judged as too short for busy channels—you'll see the following message at each command prompt:

```
WARNING: BEACON too often
```

BKONDEL *ON|OFF* Default: ON
 Mode: packet Host: BK

ON The sequence (BACKSPACE) + (SPACE) + (BACKSPACE) is echoed when a character is deleted from the input line.

OFF The backslash character (\) is echoed when a character is deleted.

BKONDEL determines how character deletion is displayed in the Command or Converse mode. With **BKONDEL ON**, the (BACKSPACE) + (SPACE) + (BACKSPACE) sequence is produced which updates your computer screen, erasing the character you want to delete.

On a printing terminal, the (BACKSPACE) + (SPACE) + (BACKSPACE) sequence will result in overtyped text. Set **BKONDEL OFF** if you have a paper-output display, or if your terminal doesn't respond to the (BACKSPACE) character, ^H (CTRL-H). When **BKONDEL** is **OFF**, the PK-96 displays a backslash for each character you delete. You can get a display of the corrected input by typing the **REDISPLAY**-line character.

BText *text* Default: empty
 Mode: packet Host: BT

text Any combination of characters up to a maximum length of 120 characters.

BTEXT is the message you want broadcasted as a beacon packet. The default text is an empty string (no message). When and how packet beacons are sent is discussed in more detail under the **BEACON** command.

Although the beacon subject is controversial in packet circles, you *can* use beacon texts intelligently *and* benefit the packet community.

- *Don't* type your call sign in **BTEXT** - the normal packet header shows it.
- *Don't* fill **BTEXT** with screen graphics; use **BTEXT** for meaningful information.
- After you've beacons for a week or two and people know who you are, follow the practice used by more experienced packeteers: set **BEACON EVERY 0**.
- Use %, &, **N**, **NO**, **NONE**, or **OFF** as arguments after you enter **BTEXT** on the command line to clear the text you previously typed in for that command.

For example: cmd: **BTEXT OFF**

CALibrate Immediate Command
 Mode: Command Host: Not Supported

CALIBRATE is an immediate command that aids you in setting the deviation level for your radio.

There are no internal adjustments to be made inside the PK-96 when using CALIBRATE.

When in CALIBRATE mode, all packet connections will be lost and the time-of-day clock will not advance until you exit the mode. Commands available in the CALIBRATE routine are:

K Toggles the PK-96's PTT circuit on and off.

Q Quits the calibration routine.

SPACE Toggles the audio tone between "mark" (low or 1.2 kHz) and "space" (high or 2.2 KHz) tones.

The PK-96 has a timer circuit that will automatically shut down the PTT circuit after it has been on for sixty seconds.

CANline *n* Default: \$18 (CTRL-X)

Mode: packet Host: CL

"*n*" 0 to \$7F (0 to 127 decimal) specifies an ASCII character code.

The argument "*n*" is the ASCII code for the character you want to use to cancel the line of text you're typing. You can enter the code in either hex or decimal.

Say you type some characters or a sentence that you want to erase and haven't yet pressed the (RETURN) key. Simply enter (CTRL-X). If you plan to assign a different ASCII character, you'd still press the (CTRL) key first, then the ASCII character you've chosen for CANLINE. For example, say you want to assign \$7E (~) as your CANLINE character. Enter:

cmd: CAN \$7E

So, when you want to cancel a line of text while in the Command mode, you'd enter (CTRL-~).

When you use the CANLINE character to cancel an input line in the Command mode, the line ends with the backslash (\) character and a new prompt (cmd:) appears on the next line to accept a new command. When you cancel a line while in the Converse mode, only a (\) and a new line appears.

Remember:

- You can cancel only the line you're currently typing.
- Once (RETURN) has been pressed, you can't cancel the line of text you just typed in.

Note: If your SENDPAC character isn't (RETURN), the CANLINE character cancels only the last line of a multi-line packet.

CANPac *n* Default: \$19 (CTRL-Y)

Mode: packet, Command Host: CP

"*n*" 0 to \$7F (0 to 127 decimal) specifies an ASCII character code.

The parameter "*n*" is the ASCII code for the character you choose to cancel, a packet message you just typed in, or to cancel the screen display output from the PK-96.

You can only cancel the packet that's currently being entered in the Converse mode. When you cancel a packet, the line is terminated with a (\) and your cursor is put on a new line. You must cancel the packet before typing the SENDPAC character.

In the Command mode, this character cancels all the output from the PK-96 to your computer screen. Entering the CANPAC character again restores normal output from your PK-96.

CASedisp *n* Default: 0 (as is)
 Mode: packet Host: CX

"n" 0 to 2 specifies how your PK-96 sends characters to your terminal.

CASEDISP allows you to set the case of the characters your PK-96 sends to your terminal; it offers three possible modes:

CASEDISP 0 "As is" -characters' case isn't changed.

CASEDISP 1 "lower" -all characters are displayed in lowercase only.

CASEDISP 2 "UPPER" -all characters are displayed in uppercase only.

CASEDISP has no effect on transmitted data from your PK-96.

CBell *ON|OFF* Default: OFF
 Mode: packet Host: CU

OFF "Bells" aren't sent with the CONNECTED or DISCONNECTED message.

ON Three BELL characters (CTRL-G) are sent to your computer with the "***CONNECTED to" or "DISCONNECTED from (call)" message.

Set CBELL *ON* if you want to be notified when someone connects to, or disconnects from, your station.

CFrom *ALL, NONE, YES/NO call1, call2..* Default: all
 Mode: packet Host: CF

call *ALL, NONE, YES list, NO list.* (list = up to 8 call signs, separated by commas.)

CFROM determines how your PK-96 responds to connect requests from other stations. CFROM is set to *ALL* when you first start your PK-96. This means your PK-96 will respond to all the connect requests addressed to it.

To reject all connect requests, type CFROM *NONE*. Your PK-96 sends the calling station a DM packet, or "busy signal." (This is like leaving your telephone off the hook.)

To accept calls from one or more specific stations, type CFROM *YES* (followed by a list of call signs). Connect requests will be accepted from stations whose call signs are listed after CFROM *YES*. For example: cmd: cfrom *YES WF7A,KG6ZL,KB6IUX,WO6P*

To *reject* calls from one or more specific stations, type CFROM *NO* (followed by a list of call signs). Connect requests will be ignored from stations whose call signs are listed after CFROM *NO*. For example: cmd: cfrom *NO WF7A,KG6ZL,KB6IUX,WO6P*

You can include optional SSIDs specified as "*-n*" after the call sign. With CFROM *NO KB6IUX*, connect attempts from all SSIDs of KB6IUX (KB6IUX-0 through KB6IUX-15) will be ignored. If CFROM is set to *YES KB6IUX-1*, then *only* KB6IUX-1 will be allowed to connect to you. Clear CFROM with %, &, or *OFF* as arguments.

CHCall *ON|OFF* Default:OFF
 Mode: packet Host: CB

OFF Call sign of originating station isn't displayed (default).

ON Call sign of the originating station *is* displayed in a multiple connection packet operation.

With CHCALL *ON*, the call sign of the originating station appears after the channel identifier even if you're connected through more than one packet station. With CHCALL *OFF*, only the channel number is displayed in a single or multiple-connection operation.

With **CHCALL OFF**, the monitored activity looks like this:

```
:0Hi, Rich—howya doin'?
Things could be better—the high winds turned my 10M vertical into a sloper!
:1*** CONNECTED to KB6IUX
:0Consider it a blessing: now you can work satellites!
:1Hey guy—did you survive the winds okay?
```

With **CHCALL ON**, the same contact now lists the connect path:

```
:0:KG6ZL:Hi, Rich—howya doin'?
Things could be better—the high winds turned my 10M vertical into a sloper!
:1:KB6IUX*:*** CONNECTED to KB6IUX
:0:KG6ZL:Consider it a blessing: now you can work satellites!
:1:KB6IUX:Hey guy—did you survive the winds okay?
```

CHDouble *ON*/*OFF* Default: **OFF**
 Mode: packet Host: **CD**

OFF Received **CHSWITCH** characters appear once (not doubled).

ON Received **CHSWITCH** characters appear twice (doubled).

Set **CHDOUBLE ON** when operating with multiple connections to tell the difference between **CHSWITCH** characters received from other stations and **CHSWITCH** characters generated by your PK-96. In the following example **CHDOUBLE** is *ON* and **CHSWITCH** is set to “!” (\$7C):

| this is a test.

The sending station actually transmitted:

| this is a test.

The same packet received with **CHDOUBLE OFF** would be displayed as:

| this is a test.

CHeck *n* Default: 30 (300 sec.)
 Mode: packet Host: **CK**

“*n*” 0 to 250 specifies the **CHECK** time in ten-second intervals.

0 Zero disables this feature.

CHECK sets a time-out value for a packet connection if the distant station hasn't been heard from for **CHECK** x 10 seconds.

Without the **CHECK** feature, if your PK-96 were connected to another station and the other station disappeared, your PK-96 would remain connected indefinitely, perhaps refusing connections from other stations. Your PK-96 tries to prevent this from occurring—depending on the settings of **AX25L2V2** and **RECONNECT**—by using the **CHECK** timer as follows:

- If a Version 1 link is inactive for **CHECK** x 10 seconds, your PK-96 tries to save the link by starting a reconnect sequence. The PK-96 enters the “connect in progress” state and sends “connect request” frames.
- If a Version 2 link (**AX25L2V2 ON**) is inactive and packets haven't been heard from the other station for “*n*” x 10 seconds, your PK-96 sends a “check packet” to test if the link still exists. If your PK-96 doesn't get an answer to the “check packet” after **RETRY+1** attempts, it will attempt to reconnect to the other station.

See the **RELINK** command.

CHSwitch *n* Default: \$00
 Mode: packet Host: CH

"*n*" 0 to \$FF (0 to 255 decimal) specifies an ASCII character code.

CHSWITCH (CHannel SWITCHing) selects the character used by both you and the PK-96 to show that a new connection channel is being addressed. *DO NOT USE \$30 to \$39 (0 to 9).*

If you plan to engage in multiple packet connections, you *must* select a **CHSWITCH** character. This character will be interpreted by the PK-96 to indicate that you want to select another packet channel.

The vertical bar "|" (\$7C) is a seldom used punctuation mark and makes a good switching character. To make the **CHSWITCH** character the vertical bar, simply enter the command and the vertical bar's ASCII code: **CHSWITCH \$7C**.

To change packet channels, simply type the vertical bar "|" followed by a number between 0 through 9, indicating which channel you want to use. So, to go from Channel 0 to Channel 1, you'd enter:

cmd:|1

See **CHDOUBLE** and **CHCALL** for further information on the use of **CHSWITCH**.

CMdtime *n* Default: 10 (1000 mS)
 Mode: packet Host: CQ

"*n*" 0 to 250 specifies **TRANSPARENT** mode time-out value in 100-mS intervals. If "*n*" is 0 (zero), exit from the Transparent mode requires sending the **BREAK** signal or interruption of power to the PK-96.

CMDTIME sets the time-out value in the Transparent mode. A guard time of "*n*" x 10 seconds allows escape to the Command mode from the Transparent mode while permitting any character to be sent as data.

The same Command mode entry character **COMMAND** (default CTRL-C) is used to exit the Transparent mode, although the procedure is different than from Converse mode. Three Command mode entry characters must be entered less than "*n*" x 10 seconds apart—with no intervening characters—after a delay of "*n*" x 10 seconds following the last characters typed.

The following diagram illustrates this timing:

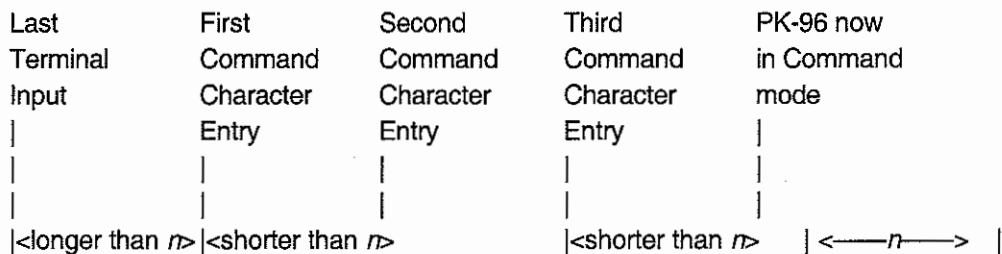

CMsG ON|OFF Default: OFF
 Mode: packet Host: CM

OFF The text message isn't sent.

ON The entered **CTEXT** message is sent as the first packet after a connection is established, after a connect request from another station.

CMsG enables or disables automatic transmission of the **CTEXT** message when your PK-96 accepts a connect request from another station. Set **CMsG ON** to send the connecting station your **CTEXT** mes-

sage. One idea is to put an invitation for the connecting station to leave a message in your MailDrop if you're not available in your CTEXT message.

CODe *n* Default: 0 (International)
 Mode: packet Host: C1
 “*n*” 0 to 6 specifies a code from the list below. (RX = Receive; TX = Transmit)

CODE	PACKET
------	--------

6	European	RX
---	----------	----

CODE 6: European

CODE 6 avoids the use of square brackets (\$5B, \$5D) in monitored packet headers and MailDrop prompts, using parentheses instead. US ASCII square bracket characters are used as extended alphabetic characters in most languages outside of English.

COMmand *n* Default: \$03 (CTRL-C)
 Mode: packet Host: CN
 “*n*” 0 to \$7F (0 to 127 decimal) specifies an ASCII character code.

COMMAND changes the Command mode entry character. Type the COMMAND character to enter the Command mode from either the Converse or Transparent mode. After you enter the COMMAND character, the Command prompt (cmd:) should appear, indicating successful entry into the Command mode. See CMDTIME for more information.

CONmode *CONVERSE|TRANS* Default: CONVERSE
 Mode: packet Host: CE

CONVERSE Your PK-96 enters the Converse mode when a connection is established.

TRANS Your PK-96 enters the Transparent mode when a connection is established.

CONMODE selects the mode your PK-96 enters after entering the “connected” state. For general operation, use the default setting.

CONNECT *call1 (Via call2,call3,...call9)* Immediate Command
 Mode: packet Host: CO

call1 Call sign of the station you want to connect to.

call2-9 Optional call sign(s) of up to eight stations you can leapfrog through to reach *call1*.

Use the CONNECT command to send a packet connect request to station *call1*, directly or VIA (through) one or more “digipeaters” (*call2* through *call9*). Each call sign can include an optional SSID-*n* immediately after the call sign.

For example, say you want to digipeat through two stations that are on a linear radio path to the third station, the one you want to talk to. You’d type something like this after the cmd: prompt:

C *WF7A V KG6ZL,KB6IUX-1,WO6P*

This string means that you want to CONNECT to *WF7A* Via (through) station *KG6ZL*, then *KB6IUX-1*, then *WO6P*. The path looks like this:

You ® KG6ZL ® KB6IUX-1 ® WO6P ® WF7A

You can type **CONNECT** at any time to check the PK-96's connect status. If you're in the process of trying to connect to another station, you'll see the message:

```
Link state is: CONNECT in progress
```

If the other station doesn't *ack* your connect request after the number of tries set with **RETRY**, the connect attempt is canceled. Your monitor would display:

```
cmd:*** Retry count exceeded
*** DISCONNECTED: calll
```

CONOK ON|OFF Default: ON

ON - Connect requests from other stations will be accepted if **CFROM** is set to **ALL**.

OFF - Connect requests from other stations will not be accepted if **CFROM** is set to **ALL** or **NONE**.

CONOK is included only to maintain upward compatibility with the TAPR TNCs and some BBS software that depend on this command being there. The command **CFROM** is much more versatile, and should be used instead of **CONOK**.

Make sure that **CFROM** is set to **ALL** if your software needs **CONOK**.

CONPerm ON|OFF Default: OFF

Mode: packet

Host: CY

OFF The current channel can be disconnected from the other stations.

ON The connection on the current channel is maintained.

With **CONPERM ON**, the PK-96 is forced to maintain the current connection, even when the number of frames to the other station exceeds **RETRY** attempts for an acknowledgment.

CONStamp ON|OFF Default: OFF

Mode: packet

Host: CG

OFF Connect status messages aren't time stamped.

ON Connect status messages *are* time stamped.

CONSTAMP activates time stamping of ***** CONNECTED** status messages. If **CONSTAMP** is **ON** and **DAYTIME** (the PK-96's internal clock) is set, the time is sent with **CONNECT** and **DISCONNECT** messages. For example, if the clock is set and **CONSTAMP** is **ON**, a connect and disconnect sequence would appear like this:

```
cmd:10:55:23*** CONNECTED to KB6IUX
cmd:10:55:59*** DISCONNECTED: KB6IUX
```

CONVerse (or K) Immediate Command

Mode: packet

Host: Not Supported

CONVERSE is an immediate command that causes the PK-96 to switch from the Command mode to the Converse mode. The letter "**K**" may also be used.

Once the PK-96 is in the Converse mode, all the characters typed into the keyboard are transmitted by your radio. To return the PK-96 to the Command mode, type the Command mode entry character, (CTRL-C).

CPactime *ON|OFF*

Default: OFF

Mode: packet

Host: CI

OFF Packet transmit timer isn't used in the Converse mode.

ON Packet transmit timer *is* used in the Converse mode.

CPACTIME activates automatic, periodic packet transmission in the Converse mode.

With CPACTIME *ON*, characters are "packetized" and transmitted periodically as if in Transparent mode. Local keyboard editing and display features of the Converse mode are available. See the PACTIME command for a discussion of how periodic packetizing works.

CStatus *SHORT*

Immediate Command

Mode: packet

Host: Not Supported

CSTATUS is an immediate command helpful in keeping track of your PK-96's activity while singly or multiply-connected to other stations. When CSTATUS is typed, your monitor displays the link status of all ten channels as well as the current input/output channel as follows:

<u>Not connected</u>	<u>Connected to two stations</u>
cmd:cs	cmd:cs
Ch. 0 - IO DISCONNECTED	Ch. 0 - IO CONNECTED to WF7A
Ch. 1 - DISCONNECTED	Ch. 1 - CONNECTED to WF7A-1
Ch. 2 - DISCONNECTED	Ch. 2 - DISCONNECTED
Ch. 3 - DISCONNECTED	Ch. 3 - DISCONNECTED
Ch. 4 - DISCONNECTED	Ch. 4 - DISCONNECTED
Ch. 5 - DISCONNECTED	Ch. 5 - DISCONNECTED
Ch. 6 - DISCONNECTED	Ch. 6 - DISCONNECTED
Ch. 7 - DISCONNECTED	Ch. 7 - DISCONNECTED
Ch. 8 - DISCONNECTED	Ch. 8 - DISCONNECTED
Ch. 9 - DISCONNECTED	Ch. 9 - DISCONNECTED

CSTATUS will give a short display if desired. CSTATUS *SHORT*, or *CS S*, displays only the current input/output channel or those channels which are connected.

CText *text*

Default: empty

Mode: packet

Host: CT

text Any combination of up to 120 characters, including spaces.

CTEXT is the "answering machine" message sent when CMSG is *ON*. The message is sent only when another station connects to you. A typical CTEXT message might be:

Hiya! I'm not available right now, so please leave a message in my MailDrop, WO6P-1.

Clear CTEXT text by using the following arguments: %, &, *NO*, *NONE*, or *OFF*, or simply set CMSG *OFF*.

CUstom *n* Default: \$0A15
 Mode: packet Host: Cu

"*n*" 0 to \$FFFF (0 to 65,535 decimal) specifies a four-digit hexadecimal value, where each bit controls a different function described below.

CUSTOM was originally introduced to allow specialized features for custom applications to be added to the PK-96 without burdening you with extra commands. Since the **CUSTOM** command is quickly filling up, **UBIT** has been added to replace **CUSTOM** to allow for additional features. The **CUSTOM** command is retained for compatibility, but we recommend using the **UBIT** command as it's more flexible and easier to use.

For those applications that can't take advantage of the **UBIT** command, the following **CUSTOM** features are available in this release of the PK-96:

- | | |
|--------------------------|--|
| Bit 0, position \$0001: | If bit 0 is set to 1 (default), the PK-96 will discard a received packet if the signal is too weak to light the DCD LED. If set to 0, packets will be received regardless of the Threshold knob's setting. |
| Bit 1, position \$0002: | If bit 1 is set to 0 (default), then setting the MONITOR command to either ON or YES will result in a MONITOR value of 4. If bit 1 is set to 1, then MONITOR ON or YES will force the MONITOR value to 6. |
| Bit 2, position \$0004: | If bit 2 is set to 1 (default), a break on the RS-232 line will put the PK-96 into the Command mode (except from Host mode). If set to 0, a break on the RS-232 line will not affect the PK-96. |
| Bit 3, position \$0008: | If bit 3 is set to 0 (default), packet channel numbers will be numbered from 0-9. If bit 3 is set to 1, then packet channel numbers are labeled A-J or a-j. |
| Bit 4 | Not used. |
| Bit 5, position \$0020: | If bit 5 is set to 0 (default) the PK-96 will always power up in the Command mode. If bit 5 is set to 1, then the PK-96 will remain in the previous mode, that is, Converse, Command, or Transparent mode. |
| Bit 6, position \$0040: | If bit 6 is set to 0 (default), then monitoring is disabled in the Transparent mode. If bit 6 is set to 1, then monitoring is active in the transparent mode. MFROM , MTO , MRPT , MONITOR , MCON , MPROTO , MSTAMP , CONSTAMP , and MBX are all active. |
| Bits 7-12: | Not used. |
| Bit 13, position \$2000: | If bit 13 is set to 0 (default), MailDrop connect status messages are always sent to the local user, regardless of the setting of MDMON . If bit 13 is set to 1, remote user dialog and connect status messages with the MailDrop are shown only if MDMON is ON . |
| Bit 14, position \$4000: | If bit 14 is set to 0 (default), the transmit buffer for data sent from the computer to the PK-96 in packet mode is limited only by the PK-96 memory. If bit 14 is set to 1, the serial flow control will permit only a maximum of 7 I-frames to be held by the PK-96 before transmission. This solves a problem with the YAPP binary file transfer program, which relies on a small TNC transmit buffer to operate correctly. |
| Bit 15: | Unused at the present time. |

To return **CUSTOM** to the default setting, type **CU Y** or **CU ON** at the command prompt.

DAYStamp *ON|OFF* Default: OFF
 Mode: packet Host: DS

OFF Only the *time* is included in CONSTAMP and MSTAMP.

ON The *date* is included in CONSTAMP and MSTAMP.

DAYSTAMP activates the date in CONSTAMP and MSTAMP. Set DAYSTAMP *ON* when you want a dated record of packet channel activity.

Daytime *date and time* Default: none
 Mode: packet Host: DA

date and time Current date and time used to set the PK-96's internal clock.

DAYTIME is used in many modes and should be set when the PK-96 is initially powered up.

The clock isn't set when the PK-96 is first turned on. The DAYTIME command displays the ?clock not set error message until it's set as follows:

YYMMDDHHMMSS

Example: cmd: daytime 940202065923

where:	<i>YY</i> is the last two digits of the year	1994
	<i>MM</i> is the two-digit month code (01-12)	Feb
	<i>DD</i> is date (01-31)	02
	<i>HH</i> is the hour (00-23)	6
	<i>MM</i> is the minutes after the hour (00-59)	59
	<i>SS</i> is seconds (optional)	23

If you want the PK-96 to keep current time, either keep its power supply on, have the software program you're using set the clock upon start-up, or install a dedicated clock chip like the SmartWatch clock chip by Dallas Semiconductor. Use chip DS1216C for PK-96's with an 18K mailbox or DS1216D for PK-96's with a 100K mailbox.

Installation is easy: Carefully remove U3, install the SmartWatch chip into U3's socket, then insert U3 into the top of the SmartWatch chip. Enter the time and date in DAYTIME and you're set. The only time the SmartWatch is read is upon power-up, RESTART or RESET.

Dallas Semiconductor, 4350 Beltwood Parkway, Dallas, TX 75244. Phone: (214) 450-0400. (You can also order the chip from JDR Microdevices, 1-800-538-5000.)

DCdconn *ON|OFF* Default: OFF
 Mode: packet Host: DC

OFF RS-232 cable Pin 8 is permanently set high (default).

ON RS-232 cable Pin 8 follows the state of the CON (or DCD) LED.

DCDCONN defines how the DCD (Data Carrier Detect) signal affects pin 8 in the RS-232 interface to your computer or terminal. Some programs such as PBBS software require that DCDCONN be *ON*.

DCDCONN also works in the RAWHDLC and KISS modes. In RAWHDLC and KISS, no packet connections are known to the PK-96. With DCDCONN *ON*, the state of the radio DCD is sent to the RS-232 DCD pin (pin-8). This may be necessary to some Host applications that need to know when the radio channel is busy.

DELeTe ON|OFF

Default: OFF

Mode: packet

Host: DL

OFF The (BACKSPACE) (\$08) key is used for editing your typing.**ON** The (DELETE) (\$7F) key is used for editing your typing.Use the **DELETE** command to select the key to use for "backing up" and deleting text.Refer to **BKONDEL** to see how the PK-96 indicates deletion.

DFrom ALL, NONE, YES/NO call1, call2...

Default: All

Mode: packet

Host: DF

call *ALL, NONE, YES list, NO list.* (list = up to eight call signs, separated by commas and no spaces.)**DFROM** determines how your PK-96 responds to stations trying to use your station as a digipeater. **DFROM** is set to *ALL* when you first start your PK-96. Type **DFROM** to display the *ALL, NONE, YES list/NO list* status of station's call signs whose packets will or won't be digipeated.To allow one or more specific stations to digipeat through your station, type **DFROM YES**, followed by a list of call signs. To *prevent* one or more specific stations from digipeating through your station, type **DFROM NO** (followed by a list of call signs). To prevent all stations from digipeating through your station, type **DFROM NONE**.Clear **DFROM** with **%**, **&**, or **OFF** as arguments.

DIGipeat ON|OFF

Default: ON

ON - The PK-96 will digipeat packets from all other stations if **DFROM** is set to *ALL*.**OFF** - The PK-96 will not digipeat packets from other stations if **DFROM** is set to *ALL* or *NONE*. **DIGIPEAT** is included only to maintain upward compatibility with the TAPR TNCs and some BBS software that depend on this command being there. The command **DFROM** is much more versatile, and should be used instead of **DIGIPEAT**.Make sure that **DFROM** is set to *ALL* if your software needs **DIGIPEAT**.

Disconne

Immediate Command

Mode: packet

Host: DI

DISCONNE is an immediate command that initiates a disconnect command to the station you're connected to. If your disconnect command is successful, your monitor will display:

*** DISCONNECTED: (call)

Other commands can be entered while a disconnect is in progress. New connections aren't allowed until the disconnect is completed.

If another disconnect command is entered while your PK-96 is trying to disconnect, your PK-96 will instantly switch to the disconnected state.

DISPlay class Immediate Command
 Mode: Command Host: Not Supported

class Lists commands and their current settings, depending which argument you enter for *class*. When **DISPLAY** is typed without a parameter, the PK-96 responds with a short list of often-used parameters.

One of the most important commands is **DISP**—it generates a list of commands and their saved (current) arguments or values. To see a brief list, enter **DISP**. Your screen should now display:

```
(See also DISPLAY A,B,C,F,I,L,M,R,T,Z)
ConnectLink state is: DISCONNECTED
Opmode                Packet
EXPert                OFF
FRack 5 (5 sec.)
HBaud 1200
MAXframe                4
Monitor4              (UA DM C D I UI)
MYcall                PK96
MYSelcal              none
PACLen                128
TXdelay                30 (300 mS)
cmd:
```

By typing an argument after **DISP**, like **DISP A**, you can call up a sub-list with a different set of commands. If you want to list *all* of the available commands and their settings, enter **DISP Z**.

The arguments for *class* are:

- (A)sync displays asynchronous port parameters
- (B)BS displays packet and MailDrop parameters
- (C)haracter displays special characters
- (D)d displays ID parameters
- (L)ink displays link parameters
- (M)onitor displays monitor parameters
- (T)iming displays timing parameters
- (Z) displays the entire command/parameter list

...and here are their default listings:

```
cmd:DISP A
8Bitconv OFF
ACRDisp 0
AFilter OFF
ALFDisp ON
AUTOBaud OFF
AWlen 7
BBSmsgs OFF
CASedisp 0 (as is)
DCdconn OFF
Echo ON
EScape OFF
Flow ON
ILfpack ON
NUCr OFF
NULf OFF
NULLs 0
PARity 3 (even)
TBaud 1200
TRFlow OFF
TXFlow OFF
XFlow ON
cmd:
cmd:DISP B
3Rdparty OFF
FREe 19712
KILONFWD ON
```

LAsmsg 0
 MAildrop OFF
 MDMon OFF
 MDPrompt Subject:/Enter message, ^Z
 (CTRL-Z) or /EX to end
 MMsg OFF
 MTExt Welcome to my AEA PK-96
 Maildrop. Type H for help.
 MYMail none
 cmd:

cmd:DISP C
 BKondel ON
 CANline\$18 (CTRL-X)
 CANPac \$19 (CTRL-Y)
 CHCall OFF
 CHDouble OFF
 CHSwitch \$00
 COMmand \$03 (CTRL-C)
 DElete OFF
 PASs \$16 (CTRL-V)
 REDispla \$12 (CTRL-R)
 SENDpac \$0D (CTRL-M)
 STArt \$11 (CTRL-Q)
 STOP \$13 (CTRL-S)
 TIme \$14 (CTRL-T)
 XOff \$13 (CTRL-S)
 XON \$11 (CTRL-Q)
 cmd:

cmd:DISP I
 Unproto CQ
 Beacon EVERY 0 (00 sec.)
 BText
 CBell OFF
 CMSg OFF
 CText
 CUsom \$0A15
 HIid OFF
 HOMebbs none
 MIid 0 (00 sec.)
 MYAlias none
 MYcall PK96
 MYALTcal none
 MYGate none
 cmd:

cmd:DISP L
 Connect Link state is: DISCONNECTED

ACRPack ON
 ALFPack OFF
 Ax2512v2 ON
 CFfrom all
 CONMode CONVERSE
 CONPerm OFF
 DFrom all
 FULLdup OFF
 GUsers 0
 HBaud 1200
 MAXframe 4
 NEwmode ON
 NOmode OFF
 PACLen 128
 PASSall OFF
 RELink OFF
 REtry 10
 SQuelch OFF
 TRIes 0
 USers 1
 Vhf ON
 XMITok ON
 cmd:

cmd:DISP M
 CONStamp OFF
 DAYStamp OFF
 HEAdErIn ON
 MBell OFF
 MBx none
 MCon 0 (none)
 MDigi OFF
 MFilter \$80
 MFrom all
 Monitor 4 (UA DM C D I UI)
 MProto OFF
 MRpt ON
 MStamp OFF
 MTo none
 MXmit OFF
 TRACe OFF
 WHYnot OFF
 cmd:

cmd:DISP T
 ACKprior OFF
 AUdelay 2 (20 S)
 AXDelay 0 (00 mS)
 AXHang 0 (000 mS)
 CHeck 30 (300 sec.)
 CMdtime 10 (1000 mS)

CPactime OFF
 DWait 16 (160 mS)
 FRick 0 (00 mS)
 FRack 5 (5 sec.)
 PACTime AFTER 10 (1000 mS)
 PERSIST 63

PPersist ON
 RESptime 0 (000 mS)
 SLOttime 30 (300 mS)
 TXdelay 30 (300 mS)

cmd:

cmd:DISP Z

Lists all the above commands in alphabetical order

DWait *n* Default: 16 (160 mS)

Mode: packet Host: DW

"*n*" 0 to 250 specifies wait time in 10 mS intervals.

Unless the PK-96 is waiting to transmit digipeated packets, DWAIT forces your PK-96 to pause DWAIT x 10 mS after last hearing data on the channel before keying your transmitter.*cmd:DISP A*

DWAIT is an old way collisions with digipeated packets were avoided. These days, the P-Persistent method is generally used. With PERSIST ON (default), the DWAIT timer is ignored.

Echo *ON|OFF* Default: ON

Mode: packet Host: EC

ON Characters received from the terminal are echoed by the PK-96.

OFF Characters *aren't* echoed.

The ECHO command controls local echoing by the PK-96 when in the Command or Converse mode, but not in the Transparent mode.

- Set ECHO *ON* (default) if you don't see your typing appear on your display.
- Set ECHO *OFF* if you see each character you type twice.

ECHO is set properly when you see the characters you type displayed correctly.

EScape *ON|OFF* Default: OFF

Mode: packet Host: ES

OFF The (ESCAPE) character is output as ESCAPE (\$1B) (default).

ON The (ESCAPE) character (\$1B) is output as "\$" (\$24).

ESCAPE selects the character to be output when an (ESCAPE) character is sent to the terminal. The (ESCAPE) character selection is provided because some computers interpret the ESCAPE character as a special command. Set ESCAPE *ON* if you have an ESCAPE-sensitive computer to avoid unexpected results from accidentally receiving this character.

EXPert *ON|OFF* Default: OFF

Mode: packet Host: EX

OFF Disables some of the less frequently used commands in verbose mode.

ON Enables all commands in verbose mode.

EXPERT controls your access to the PK-96's command set. Because some new PK-96 owners understandably find the large number of available commands confusing or daunting, this command limits the newcomer's access to the commands that are the simplest or the most often used. Generally, about half of the total number of commands are available to you after a RESET (EXPERT OFF).

With EXPERT OFF, expert-level commands may not be accessed and don't appear in any output of the DISPLAY command—an attempt to use one of these commands will result in the error message “?EXPERT command.”

All immediate commands (e.g., CONNECT and PACKET) are “Novice” commands. The error message for an Expert command is now separate from the unknown command message:

```
cmd:BBQ
?What?
cmd:FRICK
?EXPERT command
```

In Host mode, all commands are available, regardless of the setting of EXPERT. This command won't affect operation of Timewave PAKRAIT programs.

The following display lists denote when a command is available when EXPERT is OFF (“Novice”). “Retain” means the command keeps its setting during a REINIT operation.

```
cmd:DISPLAY A
8Bitconv  Novice  Retain
ACRDisp
AFilter
ALFDisp
AUTOBaud
AWlen      Novice  Retain
BBSmsgs
CASedisp
DCdconn
Echo
EScape
Flow
ILfpack
NUCr
NULf
NULLs
PARity     Novice  Retain
TBaud      Novice  Retain
TRFlow
TXFlow
XFlow

MDMon      Novice  Retain
MDPrompt   Novice  Retain
MMsg       Novice  Retain
MText      Novice  Retain
MYMail     Novice  Retain

cmd:DISPLAY C
BKondel
CANline
CANPac
CHCall
CHDouble
CHSwitch   Novice
COMmand
DElete
PASS
REDispla
SENDPAC
STArt
STOp
Time
XOff
XON

cmd:DISPLAY B
3Rdparty   Novice  Retain
FREe
KILONFWD
LAsmsg
MailDrop   Novice  Retain

cmd: DISPLAY I
Unproto    Novice  Retain
Beacon
BText
CBell
CMSg       Novice  Retain
```

CText	Novice	Retain	HEAdErln		
CUStom			MBell		
HIId	Novice		MBx		Retain
HOmEbbs		Retain	MCon	Novice	
MIId	Novice		MDigi	Novice	
MYAlias		Retain	MFilter	Novice	
MYcall	Novice	Retain	MFrom		Retain
MYGate	Novice	Retain	Monitor	Novice	
MYIdent	Novice	Retain	MProto		
			MRpt		
cmd: DISPLAY L			MStamp	Novice	
ACRPack			MTo		Retain
ALFPack			MVia		Retain
Ax25l2v2			MXmit		
CFrom	Retain		STATUS		
CONMode			TRACE		
CONPerm	Retain		WHYnot	Novice	
DFrom	Retain				
FULLdup			cmd:DISPLAY T		
GUsers	Novice		ACKprior		
HBaud	Novice	Retain	AUdelay		
MAXframe	Novice		AXDelay		
NEWmode			AXHang		
NOmode			BXDelay		
PACLen	Novice		CHeck		
PASSAll			CMdtime		
RADio	Novice		CPactime		
RELInk			DWait		
REtry	Novice		FRack	Novice	
SQuelch			FRick		
TRIEs	Novice	Retain	PACTime		
USers	Novice		PErsist	Novice	
VHF	Novice		PPersist		
XMITOK	Novice		RESptime		
			SLOttime	Novice	
cmd: DISPLAY M			TXdelay	Novice	
CONStamp	Novice				
DAYStamp	Novice				

Flow *ON/OFF*

Default: ON

Mode: packet

Host: FL

ON Type-in flow control is active.

OFF Type-in flow control is inactive.

With *FLOW ON* (default), any character typed on your keyboard halts the output from your PK-96 to the computer until any of the following occurs:

- A packet is sent (in Converse mode).
- A line is completed (in Command mode).

- The packet length *****(PACLEN)**** is exceeded.
- The current packet or command line is cancelled
- The REDISPLAY character is typed.
- The packet channel is changed.

Setting FLOW *ON* prevents received data from interfering with your keyboard data entry. With FLOW *OFF*, data is sent to the terminal whenever it's available.

FRack *n* Default: 5 (5 sec.)

Mode: packet Host: FR

"*n*" 1 to 15, specifying timeout in 1 second intervals.

FRACK is the FFrame ACKnowledgment time in seconds that your PK-96 will wait for acknowledgment of a sent protocol frame before "retrying" that frame.

After sending a packet requiring acknowledgment, the PK-96 waits for FRACK seconds before increasing the retry counter and sending another frame. If the packet address includes any digipeaters, the time between retries is adjusted to:

Retry interval (in seconds) = $n \times (2 \times m + 1)$, where "m" is the number of intermediate relay stations.

When a packet is retried, a random wait time is added to any other wait times. This avoids lockups where two packet stations repeatedly collide with each other because of timing conflicts.

FRFe Immediate Command

Mode: packet Host: FZ

Typing FREE displays the number of usable bytes left in the MailDrop, as in FREE 3724. This may be useful to a Host mode application using the MailDrop.

FRick *n/n* Default: 0/0 (0 sec.)

Mode: packet Host: FF

"*n*" 0 to 250, specifying the FRACK timeout for meteor scatter work in 10 mS increments.

FRICK is a short version of FRACK, meant to be used in packet radio meteor scatter work. If FRICK is 0 (default), the FRACK timer is then used and the PK-96 operates as before with the retry timer in units of whole seconds. If FRICK is 1 to 250, it overrides FRACK as the unit's retry timer, and the retry timer is in units of 10 mS up to 2500 mS (2.5 seconds).

Unlike FRACK, FRICK doesn't take into account the number of digipeaters in the connect path. FRICK assumes that no digipeaters are being used.

NOTE:

Do not attempt multiple packet connections while FRICK is active (1-250). In contrast to FRACK, which provides one retry timer per multi-connect channel, there is only one FRICK timer in the PK-96. Each channel will try to use the same FRICK timer, causing interference to the operation of the other channels.

Due to the sporadic nature of meteor scatter work, a Master/Slave mode can be enabled in the PK-96 with User BIT 18 (UBIT 18). With UBIT 18 OFF, FRACK operates the same as before.

With **UBIT 18 ON**, a master/slave relationship is established in packet radio connections. This is done to reduce the possibility of simultaneous transmissions by both sides of a packet connection. In this mode, the master station sends either an I-frame or a polling frame upon the expiration of **FRICK** (or **FRACK** if **FRICK = 0**). The **FRICK** or **FRACK** timer then starts counting again. The master station therefore sends packets constantly, even if all its I-frames have been acknowledged. The slave station sends nothing, not even I-frames, until it receives a polling frame from the master. A station becomes the master upon its transmission of a **SABM** (connect) frame; a station becomes the slave upon its transmission of a **UA** (acknowledgment of the **SABM**) frame.

Recommended settings for this method of meteor scatter work (both stations should use these settings):

UBIT 18 **ON**
RETRY **0**
AX25L2V2 **ON** (default)
MAXFRAME **1**
CHECK (doesn't matter)
FRICK *n*, where *n* is large enough to allow the other station time to send the start of an acknowledgment frame.

NOTE:

Frick is an experimental mode and we welcome any comments or suggestions you might have. Please make them in writing and direct them to Timewave's Engineering Department. Thanks!

FULLdup **ON|OFF** Default: OFF
Mode: packet Host: FU
OFF Full duplex mode is disabled.
ON Full duplex mode is enabled.

When full duplex mode is **OFF** (default), the PK-96 makes use of the DCD (Data Carrier Detect) signal from its modem to avoid collisions. When **ON**, the PK-96 ignores the DCD signal and acknowledges packets individually.

Full-duplex is useful for full-duplex radio operation, such as through OSCAR satellites. It shouldn't be used unless both stations can operate in full-duplex.

GENDchar *n* Default: \$0D (CTRL-M)
Mode: GPS

The default **GENDchar** of \$0D requires the string to end with a CR,LF to conform with the NMEA format. If this is changed, the sentence will end with whatever character is programmed. This command does not need to be programmed for use with GPS or Loran devices. It is intended for use with other formats.

GINIText *text* Default: None
Mode: GPS

text- Any combination of characters up to a maximum length of 60 characters.

This text will be sent to the serial port when the PK-96 is powered up with **GPSMode** NOT equal to zero. This text is intended for an initialization string for OEM GPS cards requiring setup after power-down. If not programmed, the PK-96 will send nothing at power-up.

GLOctx *n* Default: 0 (00 sec.)

Mode: GPS

“n” - 0 to 255 sets the location timing in ten-second increments.

“0” - Zero disables automatic location transmissions.

GLOctx is used to periodically transmit GPS data received on the serial port. GLOctx is programmable from 0 (never) to 255 seconds in 10 second intervals. A transmission will only occur if, GPSPMode = 1 or 2, GLOctx is not zero, and the correct NMEA information is received on the serial port.

GNMEA1 *Text (0-8 chars)* Default: \$GPGLL (GPS position only)

Mode: GPS

This is the string the PK-96 will parse from the NMEA device. The text can be any ASCII character.

GNMEA2 *Text (0-8 chars)* Default: None

Mode: GPS

This is another string the PK-96 will parse from the NMEA device. The text can be any ASCII character.

GPOLLCall *call[-"n"]* Default: None

Mode: GPS

call - The callsign you wish to use for polling.

“n” - Numeral indicating an optional SSID.

The POLLCall can be any callsign other than one already programmed in the PK-96. If programmed the same as the MYAlias, MYCall, MYGate, or MYMail callsigns, this polling feature will not work. When a packet is received addressed to the GPOLLCall callsign, the PK-96 will begin parsing the programmed NMEA command or commands. When the NMEA headers are successfully received, the PK-96 will transmit the GPS data as a UI-Frame. This GPOLLCall can also be used for digipeating.

GPSAuto *ON/OFF* Default: OFF

Mode: GPS

ON - When powered up or restarted, the PK-96 switches to GPSPMode 1 if it parses its GNMEA1 or 2 sentence within the first four seconds after power up.

OFF - The PK-96 powers up normally.

If you are using your PK-96 in your vehicle as a stand alone tracking device and in your home for regular packet operation, this command will save you a lot of hassles. Simply program all your GPS parameters except for the GPSPMode command, turn GPSAuto ON and you're set. Each time you turn your TNC on, the PK-96 will spend the first four seconds after power up trying to parse its GNMEA sentence or sentences. If it successfully parses one or both of them, it will automatically switch to GPSPMode 1.

To have the PK-96 auto detect a GPS receiver, follow these steps:

1. Be sure you have your GPS command programmed.
2. Be sure GPSAuto is turned ON.
3. Connect the GPS receiver to the PK-96 serial connector.

4. Apply power to the GPS receiver (*NOT THE PK-96 YET*).
5. Be sure that the GPS receiver is outputting its NMEA data before powering up the PK-96.
6. Power up the PK-96 and within four seconds, you should notice the PK-96 transmit LED lighting to transmit its location.

GPSTMode "n"

Default: 0 (Disabled)

This is a variable ranging from 0-3 that selects a specific mode of operation specific to GPS. Three CTRL-C's returns unit to GPSTMode 0.

Mode 0 = Normal Packet TNC operation. (GPS operation disabled.)

Mode 1 = PK-96 connected directly to a GPS receiver.

The PK-96 will begin parsing its programmed NMEA sentences under the following conditions:

1. GLOctx timer expires.
2. The PK-96 receives an Unproto frame containing *?APRS?*.
3. The PK-96 receives an Unproto frame containing *MYCALL.:?APRS?*.
4. The PK-96 receives an Unproto frame addressed to its *POLLCALL*.

Upon reception of one of these types of frames, the PK-96 will begin to parse its programmed NMEA sentences. If the PK-96 successfully parses one or both of its NMEA sentences, it will transmit the information parsed as a single UI frame. If there is no data received from the GPS receiver within four seconds, it will reset its GLOctx timer and continue.

Mode 2 = PK-96 connected directly to an ULTIMETER II.

The PK-96 will begin parsing its programmed NMEA sentences under the following conditions:

1. GLOctx timer expires.
2. The PK-96 receives an Unproto frame containing *?WX?*.
3. The PK-96 receives an Unproto frame containing *MYCALL.:?APRS?*.
4. The PK-96 receives an Unproto frame addressed to its *POLLCALL*.

Upon reception of one of these types of frames, the PK-96 will begin to parse its programmed NMEA sentences. If the PK-96 successfully parses one or both of its NMEA sentences, it will transmit the information parsed as a single UI frame. If there is no data received from the GPS receiver within four seconds, it will reset its GLOctx timer and continue.

Variable Number 3 For Commercial Use Only

Mode 3 = PK-96 connected to a GPS receiver & computer terminal (*using Timewave's Commercial GPS adapter cable*).

When the LOctx timer expires or if the PK-96 receives a UI frame addressed to its GPOLLCall, the PK-96 will switch the serial port to receive data from the GPS receiver. After the NMEA commands are parsed, the PK-96 will transmit the information obtained as a UI-frame and switch the serial port back to the computer. If there is no data received from the GPS receiver within four seconds, the PK-96 will switch back to the computer and transmit nothing.

GREMprog ON/OFF

Default: OFF

ON - Remote programming is enabled in GPS mode.**OFF** - Remote programming is disabled in GPS mode.

While operating in one of the GPS modes, the following commands can be programmed:

1. GLOCtx
2. GNMEA1
3. GNMEA2
4. GINIText
5. GSYMchar
6. Unproto

To remotely program the PK-96, the programming station must have its Unproto destination callsign set to match the GPOLLcall of the PK-96.

Example:

Let's say you have a PK-96 in your car as a stand alone tracker with its GPOLLcall set to CAR. In your house, you would program your TNC's Unproto to CAR (**U CAR**). Now place your TNC in converse mode by typing either (**K** or **CONVerse**). If you wanted to change the PK-96 in the car's Unproto path, you would simply type **U APRS via RELAY <CR>**. The TNC in your home would transmit the following frame:

Home TNC:`{your callsign}*>CAR [UI]:``U APRS via RELAY`**PK-96 in car would reply:**`PK96*>RELAY>APRS [UI]:``++ done`

Note that the PK-96 in the vehicle replied with the message `++ done`. This indicates that the command was properly received and the parameter was changed. The following is a list of additional messages and their meaning.

Remote programming messages:**Message****Meaning**`++ done`

the parameter was programmed

`++ bad`

not supported, incorrect format, or bad data

`++ too many`

too many parameters entered

`++ range`

numeric entry is too large

GSYMChar *n*

Default: 0 None

Mode: GPS

This is a Hex value ranging from 0-255 that represents a symbol in APRS software. The symbol char will be enclosed in curly brackets before all Beacon transmissions.

KG6ZL*>RELAY>APRS [UI]:

{SYMChar} This is a sample UI frame...

GUNStart *ON/OFF*

Default: OFF

Mode: GPS

ON - The PK-96 starts in CONVERSE mode after a restart or power-up.

OFF - The PK-96 will power-up in Command mode.

This command allows the PK-96 to power-up in the Converse mode if turned on.

GUSERS *n*

Default: 0

Mode: packet

Host: GU

"*n*" 0 to 3 specifies the maximum number of users allowed to use your node.

GUSERS allows up to *n* number of stations to connect to your MYGATE call. The argument "*n*" may be 0-3, with zero meaning no station can use your node. Alternatively, *n* can be thought of as the maximum number of *pairs* of stations which may be connected through your Gateway.

You must have your MYGATE call entered and GUSERS set to a number greater than 0 to enable the PK-96's node function.

HBaud *n*

Default: 1200 bauds

Mode: packet

Host: HB

"*n*" values specifying the data rate in bauds from the PK-96 to the radio.

HBAUD sets the radio on-the-air baud rate and has *no* relationship to your computer terminal program's baud rate. So, with HBAUD *1200*, data leaves the PK-96 and your radio at a speed of 1200 bps, at HBAUD *9600*, it leaves at 9600 bps.

HEAderln *ON/OFF*

Default: ON

Mode: packet

Host: HD

ON The header in a monitored packet is printed on a separate line from the text.

OFF The header and text of monitored packets are printed on the same line.

With HEADERLN *ON*, the address is shown followed by a (RETURN)+LF that puts the packet text on a separate line as shown below:

```
KG6ZL>WF7A:
Go ahead and send the file, Rich.
```

With HEADERLN *OFF*, the address information is shown on the same line as the packet text as shown below:

```
KG6ZL>WF7A:Go ahead and send the file, Rich.
```

HId *ON/OFF*

Default: OFF

Mode: packet

Host: HI

OFF Your PK-96 doesn't send HDLC identification.

ON Your PK-96 sends HDLC identification as a digipeater.

Set **HID ON** to force your PK-96 to send an ID packet every 9.5 minutes when it's used as a digipeater. Otherwise, leave **HID OFF** (default). The ID consists of a UI-frame with your station identification (**MYCALL**) and **MYALIAS** in the data field. It is addressed to "ID."

Please note that you can't change the 9.5-minute automatic interval timing.

HOMEbbs call Default: None
 Mode: MailDrop Host: HM

call Call sign of your Home BBS with which you have made prior arrangements to auto-forward mail. This is the call sign of your local or **HOMEBBS** that you'll use for reverse-forwarding messages. You must make special arrangements with the system operator of this BBS to set you up for reverse-forwarding. The SSID isn't compared when matching **HOMEBBS** to the source call sign of an incoming packet.

Host n Default: 0
 Mode: packet Host: HO

"n" A hexadecimal value from \$00 through \$FF setting bits from the table below that define the Host operation of the PK-96.

The Host command enables the "computer-friendly" Host communications mode over the PK-96's RS-232 link. To exit out of the Host mode, enter three (CTRL-C) characters in rapid succession or type (CTRL-A),O,H,O,N,(CTRL-W). *Sending a Break signal won't cause the PK-96 to exit from the Host mode.*

Bit 0: Controls whether the Host mode is **ON** or **OFF**.

If bit 0 is equal to 0, Host is **OFF**.

If bit 0 is equal to 1, Host is **ON**.

Bit 1: Controls the local MailDrop access.

If bit 1 is 0, then the MailDrop Send data uses the \$20 block. Read data uses the \$2F block as before. Monitored **MXMIT** data uses the \$3F (monitored receive) block type.

If bit 1 is 1, then the MailDrop send data uses the \$60 block type. Read data uses the \$70 block type. Monitored **MXMIT** data uses the \$2F (echoed) block type to differentiate between monitored, transmitted, and received frames.

Bits 2-7 are reserved for future use.

To maintain backward compatibility with older programs written to use the **ON|OFF** form of the Host command, Host **ON** is equivalent to Host \$01 described above. However, programmers must note that Host now returns a numeric value and not **ON** or **OFF** as before.

See Timewave's *PK-232MBX Technical Manual* for full information about the Host mode.

HPoll ON|OFF Default: ON
 Mode: Host Host: HP

ON The Host mode program must poll the PK-96 for all data (default).

OFF The Host mode program must accept data from the PK-96 at anytime.

With **HPOLL ON**, the Host mode program must poll the PK-96, using (CTRL-A),O,G,G, (CTRL-W), for all data that might be available to be displayed to the screen. With **HPOLL OFF**, the Host mode program must be able to accept any data from the PK-96 whenever it becomes available.

Id Immediate Command
 Mode: packet Host: ID

ID is an immediate command that sends a special identification packet. The ID command allows you to send a final identification packet when you take your station off-the-air. (HID must also be set *ON*). The identification consists of a UI-frame, with its data field containing your MYALIAS (if it's entered), MYCALL, and the word "digipeater". The ID packet is sent only if your PK-96 has digipeated any transmissions since the last automatic identification.

ILfpack *ON|OFF* Default: ON
 Mode: packet Host: IL

ON The PK-96 ignores all LF characters sent by your computer.

OFF The PK-96 transmits all LF characters sent by your computer.

The ILFPACK command permits you to control the way the PK-96 sends LF characters received from your computer while in the packet mode.

IO *n* Default: none
 Mode: packet Host: IO

"*n*" A hexadecimal value used to access the PK-96's memory and I/O locations, or read values stored at a specified ADDRESS.

The IO command works with the ADDRESS command (ADDRESS \$*aabb*) and permits access to memory and I/O locations. Use the IO command without arguments to *read* an I/O location, and with one argument—\$0 to \$FF—to *write* to an I/O location. The value in ADDRESS isn't increased after using the IO command.

In ADDRESS \$*aabb*, *aa* (01-FF) is the device address, and *bb* is the register address of the device.

In ADDRESS \$00*bb*, the IO command reads or writes data to the device at I/O address *bb*. There is no register set-up before the access. ADDRESS is used primarily as a programmer's aid and isn't needed for normal use.

KILONFWD *ON|OFF* Default: ON
 Mode: MailDrop Host: KL

ON The PK-96 deletes messages after they've been reverse-forwarded.

OFF The PK-96 doesn't delete messages after reverse-forwarding.

KILONFWD controls the disposition of a message that has been reverse-forwarded to the station whose call is input in HOMEBBS. With KILONFWD *ON*, the message is deleted automatically after it has been forwarded to make room for other messages in your MailDrop. With KILONFWD *OFF*, the message's status is changed from "F" to "Y."

Klss *n* Default: 0
 Mode: packet Host: KI

"*n*" Is a HEX number from \$00 (KISS disabled) through \$FF that enables the KISS mode selected from the table below.

The KISS mode must be entered to prepare the PK-96 for KISS operation. TCP/IP and other special applications have been written that require the KISS mode be enabled. For normal AX.25 packet operation, this command should be left at 0 or OFF (default).

The KISS command, formerly *OM|OFF*, has now been expanded to a numerical value from \$00-\$FF. This expansion supports G8BPQ's multi-drop KISS protocol. The table below describes available KISS options.

KISS \$00: KISS disabled (formerly displayed as KISS OFF)

KISS \$01: Standard KISS (same as KISS ON or KISS YES)

KISS \$03: Extended KISS

KISS \$07: Extended KISS+KISS polling enabled

KISS \$0B: Extended KISS+KISS checksum enabled

KISS \$0F: Extended KISS+KISS polling and checksum enabled

Note that KISS ON enables standard KISS operation for compatibility with existing applications.

Extended KISS mode adds these commands to the standard commands (\$x0-\$x5):

\$xC signifies data to be transmitted. Unlike the \$x0 command, the \$xC byte is followed by two frame ID bytes, then the data; when the TNC transmits the frame, it notifies the host application by echoing back FEND, the \$xC byte, the two frame ID bytes, and FEND.

\$xE is the polling command, similar to the Host "GG" command existing in AEA products. Polling makes multi-TNC KISS operation possible. If KISS polling is enabled, the TNC holds received data until the host application sends the poll command. If the TNC is holding no data, it echoes back FEND \$xE FEND. The "x" in "\$xE" must match the number in the KISSADDR command for the TNC to respond.

If the KISS checksum is enabled, a checksum byte is added to the end (before the final FEND) of all KISS blocks flowing between the TNC and the host application. The checksum is the exclusive-OR of all other bytes between the FEND bytes, taken before KISS escape transpositions. A checksum is helpful when using multiple TNCs on a marginal RS-232 link. If the PK-96 receives a KISS block with a bad checksum, it does not transmit the data.

In KISS and Raw HDLC modes, communication activity on the RS-232 link is shown by lighting the STA and CON LED's as follows:

Host to TNC Communication: STA LED illuminated.

TNC to Host Communication: CON LED illuminated.

Host OFF—entering three (CTRL-Cs)—will force KISS OFF. Details on the use of KISS TNC protocol are contained in Timewave's *Technical Reference Manual — Model PK-232 Data Controller*.

KISSAddr *n* Default: 0

Mode: packet Host: KA

"*n*" Is a number from 0-15, signifying the KISS address of the TNC's radio port.

Radio port addressing is available in the high nibble of the KISS command byte. The PK-96 compares the high nibble of the KISS command byte to KISSADDR only if extended KISS mode is enabled. If the command doesn't match KISSADDR, the PK-96 takes no action. *Exception:* the exit-KISS command \$FF works no matter what the value of KISSADDR or the status of extended KISS mode.

LAstmsg *n* Immediate Command

Mode: MailDrop Host: LA

"*n*" 0 to 999 specifies the message number of the last MailDrop message.

The number, 0-999, is the number assigned to the last message sent by a remote user (or the SYSOP) to the MailDrop. This command is handy for checking the last message sent to your MailDrop system. LASTMSG also allows the MailDrop message counter to be set to any value, or simply reset the counter to zero by entering LASTMSG 0.

MailDrop *ON|OFF* Default: OFF
 Mode: packet Host: MV

OFF Turns off the MailDrop.

ON The PK-96 operates as a personal packet station, BBS or MailDrop.

The MailDrop is a personal mailbox that uses a subset of the WORLI/WA7MBL PBBS commands. With MAIL DROP *ON*, other stations can connect to your PK-96, leave messages for you or read messages from you. Third-party messages are not accepted unless 3RDPARTY is *ON*.

MAXframe *n* Default: 4
 Mode: packet Host: MX

"*n*" 1 to 7 signifies a number of packet frames.

MAXFRAME limits the number of *nacked* packets your PK-96 permits on the radio link and the number of sequential packets your PK-96 will send.

The optimum value of MAXFRAME depends on your local channel conditions. In most cases, the default value of MAXFRAME 4 works well. When the amount of traffic is heavy, the path in use is poor, or if you're using many digipeaters, you can actually improve your throughput by reducing MAXFRAME.

Use MAXFRAME 1 for best results on HF packet.

MBEII *ON|OFF* Default: OFF
 Mode: packet Host: ME

OFF The PK-96 won't send any BELL characters to your computer while monitoring packets.

ON Will send 3 BELL characters to the terminal when the call sign(s) of the station(s) monitored match the MFROM and MTO lists.

MBELL can be used to alert you to the presence of a particular packet station (or stations) on the frequency. For example, if you want to be alerted when KG6ZL comes on frequency, you'd enter:

```
cmd:MBELL ON
cmd:MONITOR 4 (or the value you prefer)
cmd:MFROM YES KG6ZL
cmd:MTO NONE
```

With MBELL *ON*, packets from—and to all—stations are displayed, but only those packets matching the MFROM and MTO lists cause BELL to ring.

MBx *call1[,call2][-n][ALL]* Default: NONE
 Mode: packet Host: MB

call The call sign(s) of one or two stations to be monitored.

"*n*" 0 to 15, indicating an optional SSID.

MBX lets you read or record useful or needed data without having to connect or log on to the source station(s). MBX filters the received packet data so that only packets from the selected station(s) entered above are shown, without headers or repeated frames. MBX overrides normal monitor functions and can show one or both sides of a conversation.

The operation of MBX command is as follows:

- MBX NONE** All monitored frames are shown with their headers.
- MBX ALL** Only the data fields in the I-frames and UI frames are shown. Data from retried frames will be shown each time such a frame is monitored. The MFROM and MTO commands are active.
- MBX call1** Only the data in the I and UI frames to or from *call1* are shown. *call1* can be either the source or destination station. Retried frames are not shown. The MFROM and MTO commands are ignored.
- MBX call1,call2** Only the data in the I and UI frames are shown when *call1* is the source and *call2* is the destination or vice-versa. Retried frames aren't shown. The MFROM and MTO commands are ignored.

A packet connection on any channel inhibits monitoring if MBX isn't set to *NONE*. MCON only works if MBX is set to *NONE*. Clear MBX with %, &, N, NO, *NONE*, or *OFF* as arguments.

MCon *n* Default: 0 (none)
 Mode: packet Host: MC
 “*n*” 0 to 6 signifies various levels of monitor indications.

MCON works similarly to MONITOR, but MCON affects your display *only while you're connected to another station*. If MCON is set to a value between 1 and 5, frames meant for you are displayed as though MONITOR was *OFF*—you'll see only the data and not any header information. With MCON 6, frames meant for you are displayed as any other monitored frame—the headers appear with the data.

Starting with 0, as you increase the value of *n* the more “stuff” will be visible with each packet you receive:

- 0 You won't monitor any packets while you're connected.
- 1 Only unnumbered (UI) frames resulting from an unconnected transmission are displayed. Use this for an “unproto,” roundtable-type conversation where you want to read another station's packet text—sent unproto—while you're connected. This setting also displays beacons.
- 2 Numbered (I) frames are also displayed. Use this to monitor connected conversations in progress outside your own.
- 3 Connect request (SABM or “C”) frames and disconnect (DISC or “D”) frames are also displayed with the headers.
- 4 Unnumbered acknowledgment (UA) of connect- and disconnect-state frames are also displayed with either the characters “UA” or “DM” and a header.
- 5 Receive Ready (RR), Receive Not Ready (RNR), Reject (RJ), Frame Reject (FRMR) and (I) Frames are also displayed.
- 6 Poll/Final bit, PID and sequence numbers are also displayed.

See MONITOR about monitoring packets while you're *not* connected.

MDCheck Immediate Command
 Mode: MailDrop Host: M1

MDCHECK allows you to log on to your own MailDrop. After logging on, you can *EDIT*, *LIST*, *READ*, *SEND*, or *KILL* MailDrop messages.

To use MDCHECK, your PK-96 must not be connected to or linked to any packet, AMTOR, or PACTOR stations. For monitoring purposes, local access of the MailDrop is considered a connection. Enter “*B*” (*B*)ye to exit the MailDrop.

MDigi *ON*/*OFF* Default: OFF
 Mode: packet Host: MD

OFF Normal monitoring as determined by the monitoring mode commands.

ON I and UI frames having your call sign (*MYCALL* or *MYALIAS*) as the next digipeater in the field are displayed, regardless of connected status.

MDIGI lets you display packets when another station uses your station as a digipeater. If you want to monitor *all* traffic that flows through your station, set MDIGI *ON*.

You may not want to see all the data passing through your station, especially if many others use you as a digipeater. In this case set MDIGI *OFF*.

MDMon *ON*/*OFF* Default: OFF
 Mode: MailDrop Host: Mm

OFF You don't monitor a connected station's activity in your MailDrop.

ON Lets you monitor a connected station's activity in your MailDrop.

MDMON permits you to monitor activity on your MailDrop, showing you both sides of the QSO. (Packet headers aren't shown while a caller is connected.) When no one is connected to your MailDrop, channel activity is monitored according to the setting in *MONITOR*.

Note that MailDrop connect and link status messages will be displayed even with MDMON *OFF*. These status messages are important and allow you to see who is connected to your MailDrop. They can be disabled, however, with *UBIT 13*. (See *UBIT* for more information).

MDPrompt *text* Default: (see text)
 Mode: MailDrop Host: Mp

text Any combination of characters and spaces of up to 80 characters.

MDPROMPT is the command line sent to a calling station by your packet or PACTOR MailDrop in response to a Send message command. The default text is:

Subject:/Enter message, ^Z (CTRL-Z) or /EX to end

Text before the first slash is sent to the other station as the Subject prompt; text after the slash is sent as the message text prompt.

If there's no slash in the text, the subject prompt is “Subject:” and the text prompt message is Enter message, ^Z (CTRL-Z) or /EX to end.

MEemory *n* Default: NONE
 Mode: packet Host: MM
 “*n*” A hexadecimal value used to access the PK-96’s memory locations, or read values stored at a specified ADDRESS.

MEMORY works with ADDRESS (ADDRESS \$*aabb*) and permits access to memory locations. Use the MEMORY command without arguments to *read* a memory, and with one argument (\$0 to \$FF) to *write* to a memory location. The value in ADDRESS is increased after using the MEMORY command.

MFilter *n1*[,*n2*,*n3*,*n4*] Default: \$80
 Mode: packet Host: MI
 “*n*” 0 to \$80 (0 to 128 decimal) specifies an ASCII character code. (Up to four characters may be specified separated by commas.)

Use MFILTER to select up to 4 characters to be “filtered” or excluded from monitored packets with parameters *n1* - *n4*, the ASCII codes for the characters you want to filter. The special value of \$80 (default) filters all characters above \$7F and *all* control-characters except (RETURN) (\$0D), LF (\$0A), and (TAB) (\$09).

MFrom ALL|NONE or YES|NO call1[,call2...]
 Mode: packet Default: ALL
Host: MF
call ALL|NONE or YES_*list*|NO_*list* (*list* = up to eight call signs, separated by commas).

MFROM determines what packets are or aren’t to be monitored. To monitor all packets set MFROM to ALL. To stop all packets from being displayed, set MFROM and MTO to NONE.

To display packets from one or more *specific* stations, type MFROM YES followed by a list of call signs you want to monitor packets from. To block packets from one or more specific stations, type MFROM NO followed by a list of call signs you *don’t* want to hear packets from. When using MFROM, set MTO to NONE.

You can include optional SSIDs specified as “-*n*” after the call sign. For example, with MFROM NO WF7A, packets from WF7A-0 through WF7A-15 won’t be monitored. With MFROM YES WF7A-1, then only WF7A-1 will be monitored. When MFROM and MTO contain different arguments, the following priority applies:

1. ALL
2. NO_*list*
3. YES_*list*
4. NONE

Clear MFROM with %, & or OFF as arguments.

MHeard Immediate Command
 Mode: MailDrop Host: MH

MHEARD displays a list of the 18 most recently heard stations.

When DAYTIME has been set, entries in the Heard log are time stamped. With DAYSTAMP ON the date is also shown. This is an example of the MHEARD display:

DAYSTAMP ON

05-Nov-93 21:42:27 KG6ZL
 05-Nov-93 21:42:24 KB6IUX*

DAYSTAMP OFF

21:42:27 KG6ZL
 21:42:24 KB6IUX*

Previously, stations heard directly were displayed with an asterisk (W1AW*) and digipeated stations were shown without (W2SZ). Digipeating isn't used as much as it used to be—most stations now use nodes, so we've stopped using the asterisk. However, for those few cases in which a station is heard indirectly through a digipeater, that station's call sign is displayed with the message, "via digi".

In addition, I- and U-frame packets with PIDs of CF and CD are shown with the indicators "N/R" (for Net/ROM) and "IP" respectively.

Clear the MHEARD list with %, &, N, NO, NONE, or OFF.

MID *n*

Default: 0 (00 sec.)

Mode: packet

Host: Mi

"*n*" 0 - 250 specifies the Morse ID timing in units of 10-second increments.

0 Zero disables this function.

If "*n*" is set to a value between 1 and 250, the PK-96 will periodically issue a 20 WPM Morse ID. For example, a MID of 177 would cause a Morse ID to be sent every 1,770 seconds (29.5 minutes). A Morse ID will be transmitted only if a packet was sent since the last Morse ID. The Morse ID uses TXDELAY, PPERSIST, and DCD.

If MID is set to a value other than 0, ID will force a Morse ID immediately. If both HID and MID are active, the Morse ID will be sent first.

MID normally sends a Morse ID using on/off keying of the low tone. If FSK keying of both tones is desired to prevent stations from transmitting over your Morse ID, see the UBIT 12 command.

MMsg ON|OFF

Default: OFF

Mode: MailDrop

Host: MU

OFF The MTEXT message isn't sent at all.

ON The stored MTEXT message is sent as the first response after a packet connect to your MailDrop is established.

MMSG enables or disables automatic transmission of the MTEXT message when your MailDrop links with another station.

Monitor *n*

Default: 4 (UA DM C D I UI)

Mode: packet

Host: MN

"*n*" 0 to 6 sets different levels of monitoring while the PK *isn't* connected.

Starting with 0, as you increase the value of *n* the more "stuff" will be visible with each packet you intercept:

0 You won't monitor *any* packets while you're unconnected.

1 Only unnumbered (UI) frames resulting from an unconnected transmission are displayed. Use this for an "unproto," roundtable type conversation where you want to read other station's packet text—sent unproto—while you're not connected. This setting also displays beacons.

- 2 Numbered (I) frames are also displayed. Use this to monitor connected conversations in progress.
- 3 Connect request (SABM or "C") frames and disconnect (DISC or "D") frames are also displayed with the headers.
- 4 Unnumbered *acknowledgment* (UA) of connect- and disconnect-state frames are also displayed with either the characters "UA" or "DM" and a header.
- 5 Receive Ready (RR), Receive Not Ready (RNR), Reject (RJ), Frame Reject (FRMR), and (I) Frames are also displayed.
- 6 Poll/Final bit, PID and sequence numbers are also displayed.

If you want to save your PK-96's buffer from filling up with unwanted packets, set MONITOR to zero. That way, you'll still be able to store mail sent to you and receive connect requests, but the PK-96's 18K buffer won't fill up with "junk mail."

See MCON about monitoring packets while you *are* connected.

MProto *ON|OFF* Default: OFF
 Mode: packet Host: MQ
OFF Monitors only those "T" and UI frames with a PID byte of \$F0.
ON Monitors all "T" and UI frames as before.

This is in response to NET/ROM, which sends frames that have a PID of \$CF and that contain control characters. If you want to monitor every frame including those used by NET/ROM, you must turn MPROTO *ON*.

MRpt *ON|OFF* Default: ON
 Mode: packet Host: MR
ON Show digipeater path in the packet header.
OFF Show only originating and destination stations in the packet header.

MRPT affects the way monitored packets are displayed. With MRPT *ON*, the call signs of all stations in the digipeat path are displayed. The call sign of the station heard directly are flagged with an asterisk (*) as shown:

```
KB6IUX-4*>KG6ZL>W1AW-5>W1AW-4:
```

With MRPT *OFF*, only the originating station and the destination stations are displayed in the monitored packet header as shown below:

```
KB6IUX-4*>W1AW-4:
```

MStamp *ON|OFF* Default: OFF
 Mode: packet Host: MS
OFF Monitored frames aren't time stamped.
ON Monitored frames *are* time stamped.

MSTAMP activates time stamping of monitored packets. When your PK-96's internal software clock is set, date and time information is available for automatic logging of packet activity and other applications. Remember to set the date and time with the DAYTIME command, first!

With MSTAMP *OFF*, the packet header display looks like this:

```
KB6IUX-4*>KA2EYW-1>AI2Q:
```

With MSTAMP *ON* and DAYSTAMP *OFF*, the display looks like this:

22:51:33 KB6IUX-4*>KA2EYW-1>AI2Q:

MText *text* Default: See sample
 Mode: MailDrop Host: Mt

text Any printable message up to a maximum of 120 characters. (Spaces count as characters.)

MTEXT is the MailDrop's "answering machine message," similar to CTEXT. With MMSG *ON*, the MTEXT message is sent when a station links to your MailDrop. The default text is:

```
Welcome to my AEA PK-96 MailDrop.
Type H for help.
```

MTEXT can be reset with a %, &, *N*, *NO*, *NONE* or *OFF* as arguments.

MTo ALL|NONE or YES|NO call1[,call2...]
 Mode: packet Default: none
Host: MT

call ALL|NONE or YES_list|NO_list (list = up to eight call signs, separated by commas).

MTO determines which packets are to be monitored. To monitor all packets, set MTO to *ALL*; for no packets, set MTO and MFROM to *NONE*.

To display packets from other stations addressed to one or more specific stations, type MTO *YES* followed by a list of the call sign(s) you want to monitor for their packets. If you *don't* want to see the packets addressed to that (or those) station(s), type MTO *NO* followed by their call sign(s). When using MTO, set MFROM to *NONE*.

You can include optional SSIDs specified as "-*n*" after the call sign. If MTO is set to *NO WF7A*, any variation of WF7A-0,...WF7A-15 *won't* be monitored. If MTO is set to *YES WF7A-1*, then *only* WF7A-1 will be monitored.

When MFROM and MTO contain different arguments, the following priority applies:

1. *ALL*
2. *NO_list*
3. *YES_list*
4. *NONE*

Clear MTO with %, &, or *OFF* as arguments.

MXmit *ON|OFF* Default: OFF
 Mode: packet Host: Mx

OFF Don't monitor outgoing packets.

ON Monitor outgoing packets in the same manner as received packets.

With MXMIT *ON*, outgoing packets are monitored in the same manner as received packets. The monitoring of outgoing packets is subject to the settings of MONITOR, MCON, MFROM, MTO, MRPT and TRACE. Most transmitted packets occur when you're connected to someone, so MCON should probably be set to a non-zero value.

MYAlias *call [-n]* Default: none
 Mode: packet Host: MA

call Alternate digipeater identity of your PK-96.

"*n*" 0 to 15, an optional Substation ID (SSID).

MYALIAS specifies an alternate call sign (in addition to the call sign specified in MYCALL) for those households with two operators taking turns using the PK-96—your TNC will accept connections to both your MYCALL and MYALIAS. Previously, MYALIAS had been reserved only for stations digipeating

through your station. If MYMAIL isn't set, the MailDrop also accepts connections to either MYCALL or MYALIAS.

Outgoing connect attempts and Unproto frames use only MYCALL as the source call sign.

MYcall *call* [-*n*] Default: PK232
 Mode: packet Host: ML
call Your call sign.
 “*n*” 0-15, an optional Substation ID (SSID).

Use the MYCALL command to load your call sign into your PK-96—its default call sign is present in the ROM when the system is manufactured. This artificial call *must be changed* before operation.

The SSID is usually added so the PK-96 can respond to two different tasks—as a “base” station and digipeater, a digipeater and MailDrop, or a base station and MailDrop. An example of using the SSID suffix is given in *Chapter 5: Packet Operation*.

Two or more stations can't use the same call and SSID on the air at the same time. Use a different SSID if this is the case.

MYGate *call* [-*n*] Default: none
 Mode: packet Host: MY
call Node call sign used by other stations.
 “*n*” 0 to 15, an optional substation ID (SSID).

“Call” is the call sign of the node function of your PK-96. Stations can connect to your MYGATE call and then issue a connect request from there. This way, your station takes responsibility for acknowledgments of the user's packets.

MYMail *call* [-*n*] Default: none
 Mode: MailDrop Host: Ma
call The call sign you want to use for the MailDrop.
 “*n*” an optional Substation ID (SSID) or extension.

“*call*” may have an optional SSID, and must *not* be the same call sign and SSID as MYCALL. If you don't set MYMAIL, the MailDrop will use the same call sign and SSID as you entered in MYCALL. For example, with MYCALL WF7A, then MYMAIL may be WF7A-1 through WF7A-15. You can use the CTEXT and MTEXT messages to inform other stations about your MYCALL and MYMAIL call signs when they connect to you.

NEwmode *ON|OFF* Default: ON
 Mode: packet Host: NE
ON The PK-96 automatically returns to the Command mode at disconnect.
OFF The PK-96 doesn't return to the Command mode at disconnect.

Your PK-96 *always* switches to a data transfer mode—Transparent, Converse, or Command—at the time of connection unless NOMODE is ON. NEWMODE determines how your PK-96 behaves when the link is broken.

With NEWMODE ON, when the link is disconnected (or if the connect attempt fails), the PK-96 returns to the Command mode. With NEWMODE OFF, when the link is disconnected, the PK-96 remains in Converse or Transparent mode unless you manually force it to return to the Command mode.

NOMODE *ON|OFF* Default: OFF
 Mode: packet Host: NO

OFF The PK-96 changes modes according to **NEWMODE**.

ON The PK-96 switches modes only upon explicit command.

With **NOMODE OFF**, your PK-96 switches modes automatically according to **NEWMODE**. With **NOMODE ON**, your PK-96 never switches from Converse or Transparent mode to Command mode (or vice versa) by itself. Only specific commands—**CONVERSE**, **TRANS**, or (**CTRL-C**)—entered by you will change the operating mode.

NUCR *ON|OFF* Default: OFF
 Mode: packet Host: NR

OFF Null characters aren't sent to the terminal following (**RETURN**)'s.

ON Null characters *are* sent to the terminal following (**RETURN**)'s.

Some older printer-terminals require extra time for the printing head to do a (**RETURN**) and **LF**. **NUCR ON** solves this problem by making your PK-96 send null characters (ASCII code \$00) to your computer.

NULF *ON|OFF* Default: OFF
 Mode: packet Host: NF

OFF Null characters aren't sent to the terminal following **LF**s.

ON Null characters are sent to the terminal following **LF**s.

Some older printer-terminals require extra time for the printing head to do a (**RETURN**) and **LF**. **NULF ON** solves this problem by making your PK-96 send null characters (ASCII code \$00) to your computer. **NULLS** sets the number of null characters sent.

NULLS *n* Default: 0 (zero)
 Mode: packet Host: NU

"*n*" 0 to 30 specifies the number of null characters to be sent to your computer or terminal after a (**RETURN**) or **LF** when **NUCR**, or **NULF**, are *ON*.

NULLS specifies the number of null characters (ASCII \$00) to be sent to the computer after a (**RETURN**) or **LF** is sent. **NUCR** and/or **NULF** must be set to indicate whether nulls are to be sent after (**RETURN**), **LF**, or both. The null characters are sent only in the Converse and Command modes.

PACLEN *n* Default: 128
 Mode: packet Host: PL

"*n*" 0 to 255 specifies the maximum length of the data portion of a packet burst, in bytes.

0 Zero is equivalent to 256.

PACLEN sets the maximum number of characters to be sent in each packet burst. Most keyboard-to-keyboard operators use the default value of 128 bytes for routine VHF/UHF packet services. Your PK-96 automatically sends a packet when you reach "*n*" bytes. For example, if you set **PACLEN** to 256, the PK-96 will send out a packet burst after you enter 256 bytes' worth of information.

Reduce **PACLEN** to 64, or even 32, when working "difficult" HF radio paths.

PACTime *EVERY|AFTER* *n*

Default: AFTER 10 (1000 mS)

Mode: packet

Host: PT

"*n*" 0 to 250 specifies 100 mS increments.

EVERY packet time-out occurs every "*n*" x 100 mS.

AFTER packet time-out occurs when "*n*" x 100 mS passes without input from the computer.

The **PACTIME** parameter sets the amount of time, in 100 mS increments, that the PK-96 will wait for a character to be entered before sending a packet in the Transparent mode. The **PACTIME** parameter is also used in Converse mode if **CPACTIME** is *ON*.

When **EVERY** is specified, the characters you type are "packetized" every *n* x 100 mS. When **AFTER** is specified, the characters you type are "packetized" when input from the terminal stops after waiting *n* x 100 mS.

The **PACTIME** timer is not started until the first character or byte is entered. A value of 0 (zero) for "*n*" means packets are sent with no wait time.

PARity *n*

Default: 3 (even)

Mode: packet

Host: PR

"*n*" 0 to 3 selects a parity option.

PARITY sets the PK-96's parity for RS-232 terminal according to the table below:

0 = no parity

1 = odd parity

2 = no parity

3 = even parity

The parity bit, if present, is stripped automatically on input and isn't checked in Command and Converse modes. But in Transparent mode, all eight bits (including parity) are transmitted.

The change won't take effect until you enter **RESTART**. Be sure to change the computer or terminal to the same parity setting after you've entered **RESTART**.

PASS *n*

Default: \$16 (CTRL-V)

Mode: packet

Host: PS

"*n*" 0 to \$7F (0 to 127 decimal) specifies an ASCII character code.

PASS selects the ASCII character "*n*" used for the "pass" input editing commands. The **PASS** character signals that the following character is to be included in a packet text string. For example, if you're typing in text and want to enter three (RETURN)'s so you can put a line space between two paragraphs, you'd do this:

"...here's the end of the first paragraph." (CTRL-V)+(RETURN)+(CTRL-V) (RETURN). "Now this line will appear after a line space."

The line will appear at the other station like this:

"...here's the end of the first paragraph."

"Now this line will appear after a line space."

If you had just pressed (RETURN) at the end of the word "paragraph," you would have forced a packet to be sent. Press (RETURN) again, and you would have forced an empty packet to be sent. Press (RETURN)

yet again, and another empty packet would have been sent. This happens because pressing (RETURN) normally forces a packet to be sent. However, by inserting a (CTRL-V) before a (RETURN), you disable the function of (RETURN) in the Command mode and allow it to be used in your outgoing text to act as a "real" (RETURN). So, the PASS character "hides" the next character's function.

PASSALL *ON|OFF* Default: OFF
 Mode: packet Host: PX

OFF Your PK-96 will accept packets with valid CRCs *only*.

ON Your PK-96 will accept packets with valid or invalid CRCs.

PASSALL turns off the packet error-detecting control and displays received packets with invalid CRCs. PASSALL is normally turned *OFF*, to ensure that data is error-free by rejecting packets with invalid CRC fields. With PASSALL *ON*, packets are displayed despite CRC errors.

MHEARD logging is disabled since the call signs detected may be incorrect.

PEr sist *n* Default: 63
 Mode: packet Host: PE

"*n*" 0 to 255 specifies the threshold for a random attempt to transmit.

PERSIST works with PPERSIST and SLOTTIME to achieve true P-persistent CSMA (Carrier-Sense Multiple Access) in packet operation.

PK [*n*] Default: none
 Mode: packet Host: PK

"*n*" A hex number used to access the PK-96's memory and I/O locations.

PK (Peek/Poke) permits access to memory locations. To use the PK command:

- Set the memory address into the ADDRESS command.
- Use the PK command *without* arguments to read that memory location.
- Use PK with one argument 0-\$FF to write to that memory location.

RAM locations are \$8000-\$FFFF. ROM begins at \$0000. This command is primarily a programmer's aid and is not needed for normal PK-96 use.

PPersist *ON|OFF* Default: ON
 Mode: packet Host: PP

ON The PK-96 uses P-persistent CSMA (Carrier Sense Multiple Access).

OFF The PK-96 uses DWAIT for TAPR-type 1-persistent CSMA.

With PPERSIST *ON*, the PK-96 uses the PERSIST and SLOTTIME parameters for P-persistent CSMA instead of the older DWAIT CSMA procedure.

When your computer has queued data for transmission, the PK-96 monitors the DCD signal from its modem. When the channel clears, the PK-96 generates a random number between 0 and 255. If this number is less-than or equal to PERSIST, the PK-96 transmits all the frames in its queue. If the random number is greater than "P", the PK-96 waits .01 x SLOTTIME (seconds) and repeats the attempt.

PPERSIST can be used in both KISS and normal operation.

PRCon *ON|OFF* Default: OFF
 Mode: packet Host: PC

OFF There is no parallel printer connected, or it is not currently in use.

ON A parallel printer is connected to the PK-96 using a special cable.

PRCON tells the PK-96 whether or not a parallel printer is connected to it using an optional “Y” cable available from AEA. With PRCON *ON*, the mode and status LED’s are disabled; some lights may remain lit and others may flash randomly. When you’re through printing, disconnect the printer, turn PRCON *OFF* and the status LED’s will return to normal operation.

PROut *ON|OFF* Default: OFF
 Mode: packet Host: PO

ON All characters are sent to the parallel printer if PRCON is also *ON*.

OFF All text and data is sent to the terminal through the serial port.

This command is useful whenever you want to get a printed copy of what’s received by the PK-96. It’s especially valuable if you’re using a computer with the PK-96 that can’t otherwise produce a hard copy of received text or when you want to use your computer for something else, but still want to monitor channel activity.

RAWhdlc *ON|OFF* Default: OFF
 Mode: packet Host: RW

OFF The PK-96 operates in standard AX.25.

ON The PK-96 operates in a raw HDLC packet mode with Host *ON*.

The RAWHDLC command enables the PK-96 to bypass the AX.25 packet implementation and communicate directly with the hardware HDLC (Z8530). Host mode must be on to communicate with the PK-96 in the RAWHDLC mode.

See Timewave’s *Technical Reference Manual — Model PK-232 Data Controller* for full information.

REDispla *n* Default: \$12 (CTRL-R)
 Mode: packet Host: RD

“*n*” 0 to \$7F (0 to 127 decimal) specifies an ASCII character code.

REDISPLA changes the redisplay-line input editing character.

Parameter “*n*” is the numeric ASCII code for the character you’ll use when you want to re-display the current input line. Type the REDISPLA character to re-display a command or text line you’ve just typed. This can be helpful when editing a line, especially if your terminal doesn’t support (BACKSPACE). It can also be used in packet to display a packet that might have been received while you were typing. A backslash (\) is appended to the old line, and the corrected line is shown beneath it.

REINIT Immediate Command

Mode: packet Host: RI

This is an immediate command that you can use to get out of trouble caused by setting a lot of commands—especially timing parameters—to strange values. REINIT can be thought of as being halfway between RESTART and RESET. REINIT re-initializes most of the commands to their default setting, then does a RESTART, but the contents of the MailDrop and the NAVTEX message history buffers are preserved. The commands that are preserved are:

MYCALL	MYALIAS	MYMAIL	HOME BBS	MYALTCAL	LASTMSG	MBX	UNPROTO
BTEXT	CTEXT	PARITY	CFROM	DFROM	MFROM	MTO	MTEXT
	AWLEN	HOST	TBAUD	MDPROMPT			

In Host mode, the REINIT command is acknowledged by a RESTART response (RT).

RELink *ON*/*OFF* Default: OFF

Mode: packet Host: RL

OFF The PK-96 won't attempt to reestablish the failed link.

ON The PK-96 will try to automatically reconnect to the other station after the link has timed out on retries.

Set RELINK *ON* if you want the PK-96 to automatically try to reconnect to another packet station if the link fails.

RESET Immediate Command

Mode: Command Host: RS

RESET resets all of the PK-96's parameters to their default settings and reinitializes the unit to the point where you'll enter the autobaud routine. All personalized parameters, monitor lists, and MailDrop messages will be lost.

RESptime *n* Default: 0 (000 mS)

Mode: packet Host: RP

"*n*" 0 to 250 specifies 100 mS increments.

RESPTIME adds a minimum delay before your PK-96 sends acknowledgment packets. This delay may run concurrently with the default wait time set by DWAIT and any random wait in effect.

During a file transfer, RESPTIME can help avoid data and acknowledgment collisions caused by the sending stations' TNCs pausing briefly between transmitted data frames.

RESTART Immediate Command

Mode: Command Host: RT

RESTART reinitializes the PK-96 while retaining the settings you've changed or entered. The effect of RESTART is the same as turning the PK-96 off, then on again. RESTART doesn't reset the values stored in its bbRAM.

See RESET.

REtry *n* Default: 10
 Mode: packet Host: RY
 “*n*” 0 to 15 specifies the maximum number of packet retries before the PK-96 “gives up” sending that packet.

The AX.25 protocol uses the retransmission of frames that haven’t been acknowledged as a means to ensure that *all* transmitted frames are received. The number of retries that the PK-96 will attempt is set by this command. If the number of retries is exceeded, the packet link may be lost.

SENDPAC *n* Default: \$0D (CTRL-M) or (RETURN)
 Mode: packet Host: SP
 “*n*” 0 to \$7F (0 to 127 decimal) specifies an ASCII character code.

Use **SENDPAC** to select the character used to cause a packet to be sent in Converse mode. The parameter “*n*” is the ASCII code for the character you want to use to force your typed input to be sent. Use the default **SENDPAC** value, \$0D, for ordinary conversation with **ACRPACK ON** to send packets at natural intervals.

SLotime *n* Default: 30 (300 mS)
 Mode: packet Host: SL
 “*n*” 0 to 250 specifies the time the PK-96 waits between generating random numbers to see if it can transmit.

The **SLOTTIME** parameter works with the **PPERSIST** and **PERSIST** parameters to achieve true p-persistent CSMA (Carrier-Sense Multiple Access) in packet operation.

Squelch *ON|OFF* Default: OFF
 Mode: packet Host: SQ
OFF Your PK-96 responds to negative-going squelch voltage.
ON Your PK-96 responds to positive-going squelch voltage.

Normally, your PK-96 uses its CSMA (Carrier Sense Multiple Access) circuit to decide whether or not it’s clear to transmit on a packet channel. If there are non-packet signals on the channel you’re using—such as voice—you’ll want to use true RF-carrier CSMA by monitoring the squelch line voltage from your radio.

With **SQUELCH OFF**, the PK-96 inhibits transmissions when there is a positive voltage on the radio connector’s squelch input line. When there is no voltage or connection to this pin, the PK-96 allows packets to be sent.

With **SQUELCH ON**, the PK-96 will inhibit packet transmissions when no voltage is applied to the squelch input pin on the Radio connector.

NOTE:

If you need to use this command, you also need to have the black wire in the supplied radio cable hooked up.

STArt *n* Default: \$11 (CTRL-Q)
 Mode: packet Host: ST
 “*n*” 0 to \$7F (0 to 127 decimal) specifies an ASCII character code.

Use the **START** command to choose the character you want to use to restart output from the PK-96 to your computer after it has been halted by entering the **STOP** character.

See **XFLOW**.

STOp *n* Default: \$13 (CTRL-S)
 Mode: packet Host: SO

"*n*" 0 to \$7F (0 to 127 decimal) specifies an ASCII character code.

Use the **STOP** command to select the character you'll use to stop output from your PK-96 to your computer.

See the **XFLOW** command.

TBAud *n* Default: 1200 bauds
 Mode: packet Host: TB

"*n*" Specifies the data rate your computer uses to talk to the PK-96.

Set **TBAUD** to specify the terminal baud rate to be activated at the *next* power-on or **RESTART**. (A warning message reminds you of this.) Be sure you can set your computer and its communications program for the new rate.

The **TBAUD** command supports the following serial port data rates: 300, 600, 1200, 2400, 4800, 9600, and 19,200 bauds.

TClear Immediate Command
 Mode: Command Host: TC

TCLEAR clears your PK-96's transmit buffer and cancels any further transmission of data except for a few remaining packets.

You must be in the Command mode to use **TCLEAR**.

TRACe *ON|OFF* Default: OFF
 Mode: packet Host: TR

OFF Trace function is disabled.

ON Trace function is activated.

TRACE activates the AX.25 protocol display. With **TRACE ON**, all received frames are displayed in their entirety, including all header information. The **TRACE** display is shown as it appears on an 80-column display. The following monitored frame is a sample:

```
KB6IUX*>TESTER <UI>:
This is a test message packet.
```

Byte	Hex	Shifted ASCII	ASCII
000:	A88AA6A8 8AA460AE 6494AAA0 406103F0	TESTER0KB6IUX0.x'd...@a..
010:	54686973 20697320 61207465 7374206D	*449.49.0.:29.:6	This is a test m
020:	65737361 67652070 61636B65 742E0D	299032.80152:..	essage packet...

The byte column shows the offset into the packet of the first byte of the line. The hex display column shows the next 16 bytes of the packet, exactly as received, in standard hex format. The Shifted ASCII col-

umn decodes the high-order seven bits of each byte as an ASCII character code. The ASCII column decodes the low-order seven bits of each byte as an ASCII character code.

Trans	Immediate Command
Mode: packet	Host: Not Supported

TRANS switches the PK-96 from the Command mode to Transparent mode; the current state of the radio link isn't affected. Transparent mode is primarily useful for computer communications since Transparent mode "human interface" features such as input editing, echoing of input characters, and type-in flow control are disabled.

- Use Transparent mode for transferring binary or other non-text files.
- To exit the Transparent mode, type the COMMAND character, (CTRL-C), three times within the time period set by CMDTIME (default:1 second).

TRFlow ON OFF	Default: OFF
Mode: packet	Host: TW

OFF Software flow control for the computer receiving data is *disabled* in Transparent mode.

ON Software flow control for the computer receiving data is *enabled* in Transparent mode.

With TRFLOW ON, the type of flow control used by the computer receiving data in the Transparent mode is determined by how START and STOP are set.

With TRFLOW OFF, only "hardware" flow control (RTS, DTR) is available to the computer when receiving data from the PK-96 (while in Transparent mode).

With TRFLOW ON, and START and STOP are set to values other than zero, software flow control is enabled for your computer. The PK-96 responds to the START and STOP characters while remaining transparent to all other characters from the terminal.

TRles <i>n</i>	Default: 0
Mode: packet	Host: TI

"*n*" 0 to 15 specifies the current RETRY level on the selected input channel.

TRIES retrieves (or forces) the count of "retry counter" on the data channel presently selected.

If you type TRIES without an argument, the PK-96 returns the current number of tries if an outstanding unacknowledged frame exists. If no outstanding unacknowledged frame exists, the PK-96 returns the number of tries required to get an acknowledgment for the previous frame.

If you type TRIES with an argument, the "tries" counter is forced to the entered value. Using this command to force a new count of tries is *not* recommended.

TXdelay <i>n</i>	Default: 30 (300 mS)
Mode: packet	Host: TD

"*n*" 0 to 120 specifies 10 mS increments.

TXDELAY tells your PK-96 how long to wait before sending packet frame data after keying your transmitter's PTT line.

All transmitters experience a certain length of time from the instant the PTT line is keyed to when the signal is actually transmitted. The default value of 300 mS should work with almost all transceivers. In fact, many of the newer transceivers can use smaller TXDELAY values. (Crystal-controlled transceivers can of-

ten use smaller values as well.) On the other hand, tube-type transceivers and amplifiers can require a longer time to switch and may require TXDELAY to be increased. Experiment with the value to determine the shortest setting you can use reliably in packet.

Baudot and ASCII use TXDELAY to set the time span between PTT ON and the start of transmitted data.

TXFlow *OM|OFF* Default: OFF
 Mode: packet Host: TF

OFF Software flow control for the PK-96 is disabled in Transparent mode.

ON Software flow control for the PK-96 is *enabled* in Transparent mode.

With TXFLOW *ON*, the setting of XFLOW determines the type of flow control used in the Transparent mode by the PK-96 to control transmitted data; with it *OFF*, the PK-96 uses only hardware flow control to control transmitted data. All data that's sent to the terminal remains fully transparent.

With both TXFLOW and XFLOW *ON*, the PK-96 uses the Start and Stop characters (set by XON and XOFF) to control the input from the computer.

UBit *n OM|OFF* Default: 0
 Mode: packet Host: UB

"*n*" 0 to 255 specifying a User BIT that may be set *ON* or *OFF*.

UBIT is an extension of the CUSTOM command which allows up to 255 *OM|OFF* functions to be added to the PK-96 without burdening you with a large number of extra commands. The functions controlled by UBIT aren't things that you'll most likely change—still, they're important enough to some users or application programs that we have included them under the umbrella command of UBIT.

The following are examples of how to use the UBIT:

UBIT 5 Shows the present status of UBIT 5

UBIT 1 ON Sets the function controlled by UBIT 1 to *ON*

UBIT 10 T Toggles the state of the function controlled by UBIT 10

UBIT Returns the state of the last UBIT value that was accessed

Listed below are the UBIT functions and the default states that presently have been assigned. The default state of each UBIT is shown first.

UBIT 0: *ON*: The PK-96 will discard a received packet if the signal is too weak to light the DCD light.

OFF: The PK-96 will receive a packet regardless of the DCD status.

UBIT 1: *OFF*: Entering the command MONITOR *ON* or MONITOR *YES* causes the MONITOR command to be set to 4.

ON: Entering the command MONITOR *ON* or MONITOR *YES* causes the MONITOR command to be set to 6.

UBIT 2: *ON*: A Break signal received on the RS-232 line forces the PK-96 into Command mode from all the modes except Host mode.

OFF: A Break signal on the RS-232 line is ignored by the PK-96.

UBIT 3: *OFF*: Multiple connect packet channels are numbered from 0-9.

ON: Multiple connect packet channels are numbered A-J.

- UBIT 4: Not used.
- UBIT 5: *OFF*: The PK-96 will always power up in Command mode.
ON: The PK-96 will remain in the last mode (Converse, Command or Transparent) provided the battery jumper is enabled.
- UBIT 6: *OFF*: In packet, monitoring is disabled when in the Transparent mode.
ON: Packet monitoring is active in the Transparent mode. MFROM, MTO, MRPT, MONITOR, MCON, MPROTO, MSTAMP, MXMIT, CONSTAMP and MBX are all active.
- UBIT 7-12: Not used.
- UBIT 13: *OFF*: MailDrop connect status messages are always sent to you, regardless of the setting of MDMON.
ON: Remote user dialog and Connect status messages with the MailDrop are shown only if MDMON is *ON*.
- UBIT 14: *OFF*: In packet, the transmit buffer for data sent from the computer to the PK-96 is limited only by available memory.
ON: In packet, the serial flow control will permit only a maximum of seven I-frames to be held by the PK-96 before transmission. This solves a problem with the YAPP binary file transfer program which relies on a small TNC transmit buffer to operate correctly.
- UBIT 15-17: Not used.
- UBIT 18: *OFF*: In packet operation, the FRACK (or FRICK, if enabled) timer is used to retry packets that weren't acknowledged.
ON: A Master/Slave relationship is established when a packet connection is made. This is designed for meteor scatter operation and is described in detail under the FRICK command and *Chapter 5 - Packet Operation*.
- UBIT 19-21: Not used.
- UBIT 22: *ON*: In the packet mode, the PK-96 will respond to the receipt of an UNPROTO frame addressed to QRA by sending an UNPROTO ID packet frame within 1 to 10 seconds. This feature is compatible with TAPR's ANSWR QRA command.
OFF: The PK-96 doesn't respond to UNPROTO frames addressed to QRA.
- UBIT 23+: Reserved for future expansion.

Unproto call1[VIA call2(,call3...,call9)]

Default: CQ

Mode: packet

Host: UN

call1 Call to be placed in the "To" address field.

call2-9 Optional digipeater call list; up to eight calls.

UNPROTO sets the digipeat and destination address fields of packets sent in the unconnected (unprotocol) mode.

Unconnected packets are sent as Unnumbered I-frames (UI frames) with the destination and digipeat fields taken from *call1* through *call9* options. When a destination isn't specified, unconnected packets are sent to CQ.

Unconnected packets sent from other packet stations can be monitored by setting MONITOR to a value greater than "1" and setting MFROM to ALL.

The UNPROTO path and address is also used for beacon packets.

Uplink call1

Use the Uplink command to initiate a DAMA connection. Refer to the Packet chapter for an explanation of DAMA. After a connection is established, your station will be a slave and will not send any information packets until it is polled by the Master.

You can type **Uplink** (without any parameters) at any time to check the PK-96's connect status. If you're in the process of trying to connect to another station, you'll see the message:

```
Link state is: CONNECT in progress
```

If the other station doesn't *ack* your connect request after the number of tries set with RETRY, the connect attempt is cancelled. Your monitor would display:

```
cmd:*** Retry count exceeded
*** DISCONNECTED: call1
```

USers *n*

Default: 1

Mode: packet

Host: UR

"*n*" 0 to 10 specifies the number of active simultaneous connections that can be established with your PK-96.

USERS affects the way that *incoming* connect requests are handled. It doesn't affect the number of *outgoing* connections you initiate. For example:

USERS 0 Allows incoming connections on any free channel.

USERS 1 Rejects incoming connections if there are connections on 1 or more channels.

USERS 2 Rejects incoming connections if there are connections on 2 or more channels.

USERS 3 Rejects incoming connections if there are connections on 3 or more channels.

...and so on, through **USERS 10**.

WHYnot ON|OFF

Default: OFF

Mode: packet

Host: WN

ON The PK-96 generates a reason why received packets weren't displayed.

OFF This function is disabled.

During packet operation, the PK-96 may receive many packets that aren't displayed. Turning **WHYNOT** on will cause the PK-96 to generate a message explaining the reason why the received packet wasn't displayed. The messages and their meanings are:

PASSALL:	The received packet frame had errors, and PASSALL was OFF , preventing the packet from being displayed to the screen.
DCD Threshold:	The Threshold control was set too far counterclockwise. The DCD LED was off when the packet was received.
MONITOR:	The MONITOR value was set too low to receive this frame.
MCON:	MCON was set too low to receive this type of frame.
MPROTO:	MPROTO was set to OFF , and the received packet was probably a NET/ROM or TCP/IP frame.

MFROM/MTO:	The frame was blocked by the MFROM or MTO command.
MBX:	The call sign of the sending station doesn't match the call sign setting in the MBX command.
MBX Sequence:	The frame was received out of sequence, probably a retry.
Frame too long:	Incoming packet frame longer than 330 bytes. Probably a non-AX.25 frame.
Frame too short:	Incoming packet frame shorter than 15 bytes. (Only seen if PASSALL is <i>ON</i> —probably noise.)
RX overrun:	Another HDLC byte was received before the PK-96 could read the previous one out of the HDLC chip.

XFlow *ON|OFF* Default: ON
 Mode: packet Host: XW

ON XON/XOFF (software) flow control is activated.

OFF XON/XOFF flow control is deactivated – hardware flow control is enabled.

With XFLOW *ON*, software flow control is in effect—it's assumed that the computer will respond to the PK-96's Start and Stop characters defined by the XON and XOFF commands. Similarly, the PK-96 will respond to the computers start and stop characters defined by START and STOP.

With XFLOW *OFF*, the PK-96 sends hardware flow control commands by way of the CTS line and is controlled by either the RTS or the DTR line.

XMITOK *ON|OFF* Default: ON
 Mode: packet Host: XO

ON Transmit functions (PTT line) are active.

OFF Transmit functions (PTT line) are disabled.

With XMITOK *OFF*, your PK-96 will generate and send data as requested, but it won't key your radio's PTT line. Turning XMITOK *OFF* can help enable full break-in CW operation (QSK) on certain transceivers.

Xoff *n* Default: \$13 (CTRL-S)
 Mode: packet Host: XF

"*n*" 0 to \$7F (0 to 127 decimal) specifies an ASCII character code.

Use XOFF to select the Stop character to be used to stop input from the computer to the PK-96.

The Stop character default value is (CTRL-S) for computer data transfers.

XON *n* Default: \$11 (CTRL-Q)
 Mode: packet Host: XN

"*n*" 0 to \$7F (0 to 127 decimal) specifies an ASCII character code.

XON selects the PK-96 Start character that is sent to the computer to restart input from it to the PK-96.

The Start character default value is (CTRL-Q) for computer data transfers.

PK-96 Command List

COMMAND	DEFAULT	FUNCTION
3Rdparty	OFF	Enables 3rd party MailDrop messages.
8Bitconv	OFF	Enables 8-bit data in packet Converse.
ACKprior	OFF	Enables priority acknowledgment in packet.
ACRDisp	0	Sets terminal output screen width.
ACRPack	ON	Adds (RETURN)'s to transmitted packets.
AFilter	OFF	Enables all-mode receive character filter.
ALFDisp	ON	Sends <LF> after (RETURN) to terminal.
ALFPack	OFF	Sends <LF> after (RETURN) in transmitted packets.
AUdelay	2 (20 mS)	Sets delay before audio is applied after PTT.
AUTOBaud	OFF	Enables Autobaud routine at every power-on.
AWlen	7	Sets ASCII word length to RS-232 terminal.
Ax25I2v2	ON	Sets AX.25 Version 2.0 packet protocol.
AXDelay	0 (zero)	Sets packet Repeater key-up delay (x10 mS).
AXHang	0 (zero)	Sets packet Repeater hang time (x10 mS).
BBSmsgsg	OFF	Enables TAPR style status messages.
Beacon	EVERY 0	Sets the packet beacon timing (x10 seconds).
BKondel	ON	Sends <BS> <SP> <BS> for DELETE character.
BText	(Empty)	Sets the 120-byte packet BEACON message text.
CALibrat		Starts PK-96 AFSK tone calibrate mode.
CANline	\$18 (CTRL-X)	Sets the LINE DELETE character for editing.
CANPac	\$19 (CTRL-Y)	Sets the PACKET DELETE character for editing.
CASedisp	0 (as is)	Sets the display case (as is/lower/UPPER).
CBell	OFF	Enables packet connection notification.
CFrom	ALL	Sets the Connect request/accept list.
CHCall	OFF	Shows call sign after packet channel ID.
CHDouble	OFF	Shows CHSWITCH character twice.
CHeck	30	Sets Idle packet link time-out (x10 seconds).
CHSwitch	\$00	Sets the channel-select character.
CMdtime	10	Sets the Transparent Mode escape time.
CMSg	OFF	Sends CTEXT message to packet caller.
CODe	6	Avoids the use of square brackets in packet headers.
COMmand	\$03 (CTRL-C)	Sets the Command mode escape character.
CONMode	CONVERSE	Selects the mode used when data link starts.
Connect		Sends a packet connect request to (call).
CONOK	ON	Allows others to connect (TAPR).
CONPerm	OFF	Selects a permanent connection packet link.
CONStamp	OFF	Marks connections with time/date stamp.
CONVerse		Enters the Converse mode (Abbreviated "K").
CPactime	OFF	Uses PACTIME time-out in Converse mode.
CStatus		Shows status of channels (links).
CText	None	Sets 120-byte packet Connect message text.
CUstom	\$0A15	(Use UBIT instead).
DAYStamp	OFF	Includes DATE in time-stamp.
DAYtime	None	Set or read the internal time-of-day clock.
DCdconn	OFF	Sets RS-232 Pin 8 to follow DCD or Connect.
DELeTe	OFF	Uses DEL (\$7F), not (BS) (\$08) to erase.
DFrom	ALL	Sets the digipeat "yes or no" call sign list.
DIGIPEAT	ON	Allows digipeating (TAPR).
Disconne		Sends packet DISC request to distant station.
DISPlay		Shows the PK-96's parameters and arguments.

DWait	16	Sets the delay for digipeated packets.
Echo	ON	Echos typed keyboard characters.
EScape	OFF	Sends ESC character \$1B to display as \$24.
EXPert	OFF	Selects whether or not seldom-used commands are displayed.
Flow	ON	Stops displaying received data while typing.
FRack	5	Sets time (X1 sec) to wait for packet <i>ack</i> .
FREe		Displays available memory for MailDrop.
FRick	0	Sets timer for packet meteor scatter mode.
FULLdup	OFF	Enables full-duplex packet operation.
GENDchar	\$0D	Requires the string to end with a CR,LF to conform to the NMEA format.
GINIText	None	Sends text to the serial port when the PK-96 is powered up.
GLOctx	0	Sets the transmit interval for GPS data received on the serial port.
GNMEA1	\$GPGLL	Sets the string the PK-96 will parse from the NMEA device.
GNMEA2	None	Sets the second string the PK-96 will parse from the NMEA device.
GPOLLcal	None	Sets the callsign to any callsign other than the one already programmed in the PK-96.
GPSAuto	OFF	Allows PK-96 to automatically detect a connected GPS receiver.
GPSMode	0	Selects a mode of operation specific to GPS.
GREMprog	OFF	Allows the PK-96's GPS commands to be remotely programmed.
GSYMChar	0	Sets the APRS symbol to be transmitted.
GUNSTart	OFF	Allows the PK-96 to power-up in the converse mode (on) or in command mode (off).
GUsers	n	Sets the number (0-3) of users allowed to use your node.
HBaud	1200 bps	Sets the packet radio link baud rate.
HEAderin	ON	Inserts (RETURN) after monitored packet headers.
HId	OFF	Sends HDLC ID UI packet every 9.5 minutes.
HOMebbs	None	Sets call sign of the BBS for forwarding.
HOST	0 (OFF)	Enables Host computer interface.
HPoll	ON	Sets Host polling be used in Host interface.
Id		Sends an ID packet.
ILfpack	ON	Ignores line feeds from terminal.
K		Enters the Converse mode (same as CONVerse).
KILLONFWD	ON	Kills messages after reverse forwarding.
KIss	0 (OFF)	Starts the KISS TNC host protocol.
KISSAddr	0	Sets the Address used in extended KISS mode.
LAstmsg		Sets/shows the last MailDrop message number.
MailDrop	OFF	Enables the Packet MailDrop for remote users.
MAXframe	4	Sets a maximum of un-acked packet frames.
MBEII	OFF	Rings bell when a particular packet station is heard.
MBx	none, (calls)	Monitors packet channel without headers.
MCon	0 (zero)	Monitors packets while connected (0-6).
MDCheck		Allows you to check into your own MailDrop.
MDigi	OFF	Monitors packet frames that you digipeat.
MDMon	OFF	Monitors stations using your MailDrop.
MDPrompt	(see text)	Sets an 80 character MailDrop message prompt.
MFilter	\$80	Filters received ASCII characters.
MFrom	ALL (calls)	Monitors packets from other packet stations.
MHeard		Displays call signs heard.
MId	0	Enables a Morse ID to be sent in packet.
MMsg	OFF	Enables the MailDrop sign on message.
Monitor	4 (UA DM C D I UI)	Sets the packet Monitor mode level (0-6).
MProto	OFF	Enables monitoring of all packet protocols.
MRpt	ON	Shows digipeaters in packet headers.
MStamp	OFF	Time-stamps monitored packet frames.
MTExt	(see text)	Sets a 120 character MailDrop sign-on message.

MTo	<i>Empty; enter calls</i>	Monitors packets to other station call signs.
MXmit	<i>OFF</i>	Monitors transmitted packet frames.
MYAlias	<i>None</i>	Sets the alternate MYCALL for digipeating.
MYCall	<i>PK96</i>	Sets <i>your</i> packet call sign.
MYGate	<i>None</i>	Sets your node call sign.
MYMail	<i>None</i>	Sets your MailDrop's call sign.
NEwmode	<i>ON</i>	Returns to Command mode at disconnect.
NOmode	<i>OFF</i>	Sets no mode changes (e.g.. cmd: to CONVERSE).
NUCr	<i>OFF</i>	Sends Nulls to terminal after (CR).
NULf	<i>OFF</i>	Sends Nulls to terminal after (LF).
NULLs	<i>0 (zero)</i>	Sets the number of NUCR and NULF.
Opmode		Displays current operating mode.
PACLen	<i>128</i>	Sets the number user data bytes in a packet.
PACTime	<i>AFTER 10</i>	Sets the packet automatic transmit timer.
PARity	<i>3 (even)</i>	Sets the terminal program parity (0-3).
PASSs	<i>\$16 (CTRL-V)</i>	Sets the converse mode pass character.
PASSAll	<i>OFF</i>	Ignores CRC in receiving packets (Junk mode).
PErersist	<i>63</i>	Sets the P-persistent CSMA threshold.
PK		Permits access to memory locations.
PPersist	<i>ON</i>	Selects P-persistent CSMA operation.
RAWhdlc	<i>OFF</i>	Starts Raw HDLC mode.
REDispla	<i>\$12 (CTRL-R)</i>	Re-displays current terminal input buffer.
REINIT		Reinitializes the PK-96, but preserves the contents of the MailDrop.
RELink	<i>OFF</i>	Re-connects after link fails due to retries.
RESET		Resets PK-96 and bbRAM to factory defaults.
RESptime	<i>0</i>	Sets the minimum delay before sending an <i>ack</i> .
RESTART		Restarts PK-96; same as turning the power off/on.
REtry	<i>10</i>	Sets the maximum number of packet repeats.
SENDPAC	<i>\$0D (CTRL-M)</i>	Sets the converse mode "Send packet" character.
SLottime	<i>30</i>	Sets the P-persistent CSMA slot time.
SQuelch	<i>OFF</i>	Sets the receiver squelch carrier polarity.
STArt	<i>\$11 (CTRL-Q)</i>	Sets character to start sending terminal data.
STOp	<i>\$13 (CTRL-S)</i>	Sets character to stop sending terminal data.
TBAud	<i>1200 bauds</i>	Sets the terminal data rate.
TClear		Clears the transmit buffer (Non-packet modes).
Tlme	<i>\$14 (CTRL-T)</i>	Inserts the time (in DAYTIME) in text.
TRACe	<i>OFF</i>	Enables a Hex dump of received data.
Trans		Enters the Transparent data mode.
TRFlow	<i>OFF</i>	Enables software flow control RX in Transparent mode.
TRles	<i>0 (zero)</i>	Displays or forces packet retry counter.
TXDelay	<i>30</i>	Sets the PTT key-to-data delay (x10 mS).
TXFlow	<i>OFF</i>	Enables software flow control TX in Transparent mode.
UBit	<i>0</i>	Controls seldom used ON/OFF commands.
UCmd	<i>0</i>	Controls seldom used numeric commands.
Unproto	<i>CQ</i>	Sets the UI packet frame sending path/address.
Uplink	<i>Call 1</i>	Used to initiate DAMA connections.
USers	<i>1</i>	Sets allowed number of packet multi-connects.
Vhf	<i>ON</i>	Selects VHF packet wide (1 KHz) shift.
WHYnot	<i>OFF</i>	Displays reason why packet not displayed.
XFlow	<i>ON</i>	Sets Software (XON/XOFF) RS-232 flow control.
XMITOk	<i>ON</i>	Allows transmitter PTT line to be keyed.
XOff	<i>\$13 (CTRL-S)</i>	Sets character to stop sending received data.
XON	<i>\$11 (CTRL-Q)</i>	Sets character to start sending received data.
ZFree		Returns number of blocks of available memory.
ZStatus		Returns status of some internal parameters.

5. Packet Operation

Overview

In the brief time that packet radio has been around, it has grown to become the most popular digital mode found on the amateur bands today.

The Packet Modes

In packet, there are four modes available to you: Command, Converse, KISS, and Transparent.

Command mode is the launch point from where you'll jump into packet. It's here you enter commands to customize the PK-96 to your needs and it's from here you will enter the command to "connect" (chat) with someone in the Converse mode or monitor passing traffic. Even while you're connected with someone, you can return to the Command mode to change commands and perform other functions.

The Converse mode is exactly that—a mode which you call CQ, broadcast messages, and converse with other packeteers.

The KISS mode is used primarily for TCP/IP packet networking. Although not used for "normal" packet operation, it is used if you are part of a network; you'll need to have your PK-96 and radio up and running continuously. KISS is explained in *Chapter 4*.

Finally, there's the transparent mode. This mode is reserved for binary file transfers. This will be covered briefly later in this chapter.

Tuning in Packet Stations — VHF/UHF

First, enter your call sign using MYCALL. For example, if your call sign is WF7A, then you'd enter:

```
cmd: MYCALL WF7A
MYcall was PK96*
MYcall now WF7A
cmd:
```

*or AAA if you just came from the Chapter 2.

If you know there is packet activity in your area, but don't know the frequencies, try some of these:

2 meter (144-148 MHz): 144.91, 144.93, 144.95, 144.97, 144.99, 145.01, 145.03, 145.05, 145.07, 145.09.

1.25 meter (222-225 MHz): 223.40, 223.42, 223.44, 223.46, 223.48

70 cm (420-440 MHz): 440.975, 441.000, 441.050, 441.025, 441.075

You'll know you've found a packet channel when you hear the characteristic "braaaaaap" of packet transmissions. If you've made the correct connections and your radio's audio level is set properly, packets should scroll up on your screen. Some typical packets you might monitor are shown below:

```
N7ALW*>WA7GCI [C]
WA7GCI*>N7ALW (UA)
```

```

N7ALW*>WA7GCI:
Hi Bob, how are you this evening?

K6RFK>N7ALW*>N7GMF:
Good night John, it has been nice talking to you.

K6RFK>N7ALW*>N7GMF [D]
N7GMF>N7ALW*>K6RFK (UA)

KD7NM*>MAIL:
Mail for: K6RFK N7ML WO6P

WN7ANK-8*>ID:
NET/ROM 1.3 (SEA)

SEA*>N7ML:
SEA:N7HWD-8> Connected to #SEA:N7HWD-7

```

NOTE:

You might hear data (packets) which don't print on your screen. This is normal and is a function of the MONITOR and MPROTO commands.

What It Means

There are different types of packets that mean different things to your PK-96—it keeps track of and knows what to do with all these packets so you don't have to worry about them most of the time. Since the PK-96 has the capability of monitoring all the packet activity on a channel, it would be wise for you to observe what scrolls up on the screen for awhile to see how stations interact with each other.

Examine the first packet exchange in the examples above:

```

N7ALW*>WA7GCI [C]
WA7GCI*>N7ALW (UA)

```

The first call sign is the originator of the packet. The call sign after the ">" is the station the packet is addressed to. Therefore, the packet listed above originated from N7ALW and is being sent to WA7GCI. The "[C]" immediately following the two call signs identifies this packet as a connect request. So, N7ALW is trying to connect with WA7GCI.

The second packet, WA7GCI*>N7ALW (UA), is in response to N7ALW's connect request—WA7GCI responded to N7ALW with a "(UA)" which stands for Unnumbered Acknowledge; WA7GCI sent N7ALW an *ack* signal as if to say, "Yes, I acknowledge getting your packet for a connect request."

The next packet is data (text) sent from N7ALW to WA7GCI.

```

N7ALW*>WA7GCI:
Hi Bob, how are you this evening?

```

The stations are connected and are enjoying a QSO.

One benefit of packet radio is that packets can be relayed, or digipeated. In fact, packets can be "digied" by up to eight other stations to get them to a distant station you can't reach directly. In practice, digipeating through a large number of stations doesn't work well, but still you will often see packets that are digipeated through one or two stations to get to their destination. The packet shown below is an example of a digipeated packet:

```

K6RFK>N7ALW*>N7GMF:
Good night, John--it has been nice talking to you.

```

This packet originated from K6RFK and is intended N7GMF, but for one reason or another, it's being digipeated through N7ALW. Notice the asterisk (*) in the first line—it tells you which station was actually heard by N7GMF when it received the packet. In this case, we can see that we actually heard radio station N7ALW. Without the asterisk, you couldn't tell whether the transmission came from radio station K6RFK or N7ALW. More will be discussed about digipeating later, but the above example is typical.

The next packet:

```
K6RFK>N7ALW*>N7GMF [D]
```

... is again from K6RFK to N7GMF and is being digipeated through N7ALW. This packet indicates that K6RFK has finished talking to N7GMF and wants to disconnect. Again, you see that you aren't hearing K6RFK directly, but N7ALW as indicated by the asterisk (*) after his call.

```
N7GMF>N7ALW*>K6RFK (UA)
```

This packet is an *ack* that lets K6RFK know that N7GMF has *acked* the disconnect request. K6RFK and N7GMF are no longer connected.

The following packet is a BEACON packet from KD7NM.:

```
KD7NM*>MAIL:
Mail for: K6RFK N7ML W06P
```

Since the packet is addressed to "MAIL" we can assume KD7NM is a Packet Bulletin Board System (PBBS) broadcasting to the area that there's mail waiting for these three stations to read.

The following BEACON packet is an identification packet from a NET/ROM level-3 packet networking switch.

```
WN7ANK-8*>ID:
NET/ROM 1.3 (SEA)
```

In this example, the packet "switch" is operated by WN7ANK-8, but it uses the alias SEA as a MYALIAS call sign. There are many types of packet switches now in use, but NET/ROM is one of the most popular. We will briefly discuss using a NET/ROM switch later in this chapter since most switches operate in much the same way.

The packet below was sent by the network switch SEA to N7ML.

```
SEA*>N7ML:
SEA:WN7ANK-8> Connected to #SEA:N7HWD-7
```

This message tells N7ML that he is now connected to another port on the SEA "node" named #SEA. Again, we will talk more about how and why N7ML might want to do this later in the chapter.

Who's Out There?

If you don't have a friend on packet in your local area, then you will want to choose a station you can reach. Fortunately the PK-96 has a command called MHEARD that displays the list of the last eighteen stations it has heard.

After you've tuned to a packet station for half an hour or so, enter MHEARD prompt. You'll see something like this:

```

cmd: MHeard
..... WO6P
..... KB6IUX-1
..... SEA*
..... N7HWD-8*
..... KD7NM*
..... KG6ZL*
..... WF7A-9*
cmd:

cmd: MHeard (with DAYSTAMP ON)
21-Nov-93 13:40:35 WO6P
21-Nov-93 13:40:25 KB6IUX-1
21-Nov-93 13:40:01 SEA*
21-Nov-93 13:39:51 N7HWD-8*
21-Nov-93 13:39:44 KD7NM*
21-Nov-93 13:39:20 KG6ZL*
21-Nov-93 13:39:12 WF7A-9*
cmd:

```

The call signs in the list are the stations heard by your PK-96 with the most recently heard station at the top of the list. As mentioned earlier, the asterisks (*) indicate that the station was heard directly by the PK-96. The call signs without an asterisk were relayed by another station and so cannot be connected to you directly without you connecting to a node or digipeating.

Talking to Yourself

Most of us are a little nervous when we first get on-the-air in a new mode. In packet, fortunately, you're able to get a lot of practice just by talking to yourself before you send your first CQ or connect to someone else who has sent a CQ. Once you feel comfortable with the basic operation of packet, going on-the-air is a breeze! To get some practice, you can learn the important commands by talking to yourself.

Remember the "loop-back" test back in Chapter 2, where you tied the green and white wires together at the end of the radio cable? You'll do roughly the same thing here. First, remove the RADIO cable. Then, cut a short length of any single-conductor wire that may be lying around your shack and insert one bare end into Pin 1 of the RADIO port and the other bare end into Pin 4. With your communications program and PK-96 running so that the cmd: prompt is displayed, you're now all set to have a thrilling monologue.

Connecting

When you want to chat with a station in packet, you "connect" to it. The abbreviation of the CONNECT command is the letter, C. Go ahead and connect to yourself by entering: *C your call*. If your call happens to be KB6IUX, you'll type:

```

cmd: C KB6IUX
*** CONNECTED to KB6IUX

```

You have now changed from the Command mode to the Converse mode—the CON (CONnected) light is lit on the PK-96's front panel. Go ahead and type a quick sentence and press (RETURN). Your sentence will echo back at you. If you were the receiving station, the echo you see is *exactly* what would appear on your screen. Type in another sentence, but this time as you press (RETURN), watch the PK-96's front panel. The XMT and STA lights come on, then the XMT light will go out. A few moments later, the XMT light will come on briefly, then both the CON and STA lights will go out.

What's happening here? It's all part of packet's error-checking scheme. When you pressed (RETURN), the XMT light came on because the PK-96 was keying up your transmitter and sending your packet to the other station. Once the packet has been sent, the XMT light goes out and your transmitter unkeys. The STA light stays on because the PK-96 is waiting for the packet you just sent to be acknowledged (*acked*) by the receiving station. After the other station receives your packet and checks it over to see that it was received okay, it sends back a quick *ack* signal. When your PK-96 receives the other station's *ack* signal, it "*acks the ack*"; your transmitter is momentarily keyed for this to happen.

Leave the Converse mode by entering a (CTRL-C). Now you're back in the Command mode. Notice that the CON light is lit—this is because you're still connected with a station. When you enter a (CTRL-C) while you're connected, you've essentially put the other station "on hold" like you would with a telephone—you can go do anything that you can normally do while in the Command mode.

You have a couple of options now: you can either return to the Converse mode and continue chatting with the other station, or you can disconnect—which ends the QSO. To go back to the QSO enter the letter *K*—for "*K*"onverse—next to the `cmd:` prompt. You'll be put on a new line and will be able to type text or read what may have come up on your screen in your absence. While in the Command mode, if you decide to end the connection, enter the letter *D*, for Disconnect. In this example with KB6IUX, you'd see:

```
*** DISCONNECTED: KB6IUX
KB6IUX*>KB6IUX (UA)
```

Congratulations! You performed the basic steps you need to initiate and end a basic packet contact. Try this exercise a few more times until you feel comfortable with it. When you are, remove the jumper from the RADIO port and reinsert the radio cable.

CTEXT

A step you might want to take right now is to enter a CTEXT message. CTEXT is like a telephone answering machine message (up to 120 characters) that your PK-96 will send to a station immediately after it connects to you. A good CTEXT message is something like this:

```
cmd: CTEXT Hi, there! If I don't respond in a few moments to your connect, please leave a message in my mailbox, WO6P-1. Thanks! (RETURN)
```

```
CText was
```

```
CText Hi, there! If I don't respond in a few moments to your connect, please leave a message in my mailbox, WO6P-1. Thanks!
```

```
cmd:
```

With this message, the connected station has the option of waiting for you to "pick up the phone" or to leave a message in your MailDrop.

To enable your CTEXT message, turn **CMSG ON**. If you don't want your PK-96 to send the message, leave **CMSG OFF**.

When you first turn on your PK-96, it becomes a standard AX.25 packet TNC (Terminal Node Controller). All TNCs and multimode controllers have this capability. When you connect to a TNC, in most cases you'll be connecting directly to someone's computer screen. If you get a message like this . . .

```
Welcome to my packet station. If I don't respond, please leave a message and Disconnect.
```

. . . when you connect to another station, usually you would type something like "Hello?" If you don't see a response from the other station in a minute or so, simply leave a message—just like a telephone answering machine. The TNC at the other station should then hold your message until the operator returns to the computer or terminal. However, if the other operator shuts off their computer before checking the screen,

then your message will never be seen. So if the other operator doesn't answer after waiting a reasonable amount of time, try to connect to their mailbox.

Connect/Disconnect Notification (CBELL)

If you're in the ham shack but busy doing other things—or while you're connected to a station—you may want to be alerted when someone else connects to you. Turning **CBELL ON** will make your computer beep three times when another station connects or disconnects from you.

Setting Up for Transmitting

If you're using an Timewave program, follow the instructions in the program's manual.

Most packet operation is on FM simplex, so turn off the repeater offset in your radio if it's on.

Calling CQ

In order to allow amateurs to send message beacons and to call CQ, the AX.25 protocol has the ability to send packets that are intended for more than one specific packet station. Since all packets must have a destination call sign, the PK-96 sends Unprotocol packets to the call sign of CQ. This can be changed with the UNPROTO command, but most people like this since it makes an easy way to call CQ. You can call CQ in one of three ways: locally, by digipeating, or through a node.

Locally: Simply enter *K* to enter the Converse mode, press (RETURN) twice, then (CTRL-C) to return to the Command mode. Your CQ will look like this to anyone that's monitoring you:

```
(your call)*>CQ:
```

If you wanted to digipeat your CQ, say through WF7A, you'd enter it like this:

```
U CQ V WF7A (RETURN) (RETURN) (CTRL-C)
```

To listeners nearby, they'll see this on their screens:

```
(your call)>WF7A*>CQ:
```

...or if they hear your call directly, it'd be:

```
(your call)*>WF7A>CQ:
```

You can use up to eight calls in a "path" to send your CQ through a distant station.

To change the UNPROTO command to read something other than CQ, enter: UNPROTO (*text*), with (*text*) being up to six characters long.

Nodes usually have a CQ command. To call CQ through the node, you'd connect first and then enter *CQ*—the node will send your call sign out for you.

To send a CQ through a couple of nodes to a distant one, you'll have to connect to each node as described in the *Digipeating* section below.

Going On the Air

Choose one of the stations with an asterisk displayed in your MHEARD list, or a friend that you know is on the air near you, and enter:

```
cmd: C call
```

A few moments later, you should see:

```
*** CONNECTED to call
```

If you see this, you have just connected to your first packet station! Since you initiated the contact, you speak first. As you type, you may notice that the XMIT light on the PK-96's front panel comes on. This means you've typed in a PACLEN's worth of text and the PK-96 is sending it; just keep on typing until you've finished with your message. After you've finished typing, enter a couple of (RETURN)'s or press the "greater than" sign (>), followed by a (RETURN), to let the other station know that you've finished typing and that it's their turn to transmit. The other station will respond—a PACLEN's worth of characters at you at a time—then will give you a couple of (RETURN)'s or a ">" to signal you to start transmitting. This is how it goes, back and forth, until you've finished chatting. Terminate the QSO as you did before with a (CTRL-C)+(CTRL-D).

If you didn't connect according to plan, see the following section.

I'm Having Trouble Connecting

If the station you're trying to connect to is connected to someone else, you may see the following message:

```
*** BUSY call: DISCONNECTED
```

If you see this, it means that the other station is connected with someone and can't respond to you now. Simply wait a few minutes and try again or try connecting to a different station from your MHEARD list.

If the distant station can't hear your station, you may see the following:

```
*** Retry count exceeded
*** DISCONNECTED: (call)
```

A number of different things can cause this to occur. It may simply be that the station you're trying to connect to is out of your transmitter's range or is inaccessible for one reason or another. It's possible, however, that something more serious is wrong. If all of your connects don't go as smoothly as planned, go to the packet section of *Chapter 7 — Troubleshooting* for assistance.

More Packet Features

Once you have worked a packet station or two, you can learn a little more about the other capabilities of the PK-96 by reading about them in *Chapter 4 — You're In Command*.

Nodes and Node Operation

In the early days of packet radio, amateurs had to "digipeat" through many stations (up to 8) to connect to a distant station. As more users became active on packet, digipeating quickly proved to be an inefficient way of relaying packets through even a few "hops." The reason why is simple: with all the packets on-the-air being leapfrogged to reach their destination, they'd invariably "crash" into each other, meaning that stations would transmit (and retransmit) packets at the same time. As you know from voice radio operation, when two stations talk at the same time you get a garbled mess, and that's what happened—packets would crash, stations would retransmit the packets since they weren't *acked* and they'd crash again.

To solve this problem, amateurs began working on more efficient "higher level" ways of routing packets over long distances. NET/ROM™, ROSE, TCP/IP, and TEXNET are some of the higher level protocols that emerged and are currently in use around the world. An analogy to packet node operation is your body: say you stub a toe against the wall. The nerve impulse starts at your toe, is transmitted by branch nerve fibers in your leg, then on to your spine (backbone) and finally the impulse reaches its destination, the brain. Packet communications work pretty much the same way: you (the toe) would send to a node (a branch station) that would be retransmit along a digital backbone to a final destination. Instead of a central clearing-

house for signals like your brain, packet signals are routed along nodes that would retransmit a message until it reaches its destination (this, however, doesn't mean you don't need a brain to use packet.).

In practice, you'd never connect directly to a backbone station; backbone stations typically operating in the 220 MHz and 440 MHz bands (in the U.S.) and are used strictly as retransmitters of packets, not originators in the usual sense. Because these stations are not used for local traffic, they can speed packet traffic along faster and without interruption.

In summary, you don't connect to a distant station through a bunch of other stations anymore, but to a node which does all the connecting and retransmitting for you. It doesn't necessarily have to be a distant station that you're connecting to. In mountainous or hilly areas, it's common practice for all stations to connect to a node and have it retransmit the signals rather than connect directly to a nearby station. This method helps solve the packet crash problem that you read about a few paragraphs ago.

When you connect to a NET/ROM node, you won't initially see a prompt. Airtime is reduced because the NET/ROM commands are not transmitted, since there are so few commands and they are easy to memorize. Like other automatic systems however, if you send an "H" or a "?" (for Help), you can expect to get a response. For Seattle's SEA node, you'd see:

```
cmd: c sea
*** CONNECTED to SEA
?
SEA:WN7ANK-8} Invalid Command - Choose from :
Connect CQ Bye Help Info Nodes Routes Talk Stats BBS MHeard Users
Quit
```

In the above example, the Seattle node addressed as SEA is operated by WN7ANK-8. Invalid Command means that the node didn't understand the command a connected station sent, so it returned the above "help" line to remind the user of the commands it knows, which are listed below its I.D.

Your PK-96's on-board Gateway firmware supports local acknowledgment (*acks*) of packets like a full-service BBS/node does. Now, instead of users having to digipeat through your MYALIAS or MYCALL call sign to connect to a destination station, they can now simply connect to your MYGATE call sign. From there, they can issue a connect request to the station they want to reach and your station will be responsible for accepting and sending packet data and *acks* (users *can't* digipeat through your MYGATE call sign). Users can also enter the MHEARD command to see the last 18 stations *your* TNC has heard.

For your node to work, simply enter a call into MYGATE—not the same one as your MYCALL, MYALIAS, or MYMAIL—and set GUSERS to a value greater than zero. To disable the node function, enter MYGATE NONE or GUSERS to zero.

NOTE:

With each station connected to your node, you'll lose a "logical" channel. If you have GUSERS set to 3 and three source stations have connected to three destination stations through your node, they'll take up six of your ten channels, leaving you with only four channels to accept and initiate contacts. (If a station connects to your MailDrop that would leave you only three channels.)

Operating Your Node

Here's what a user would see when using you as a packet node. In this example, your MYGATE call is set to N7ML-7:

```
cmd: C N7ML-7
*** CONNECTED to N7ML-7
+++ N7ML Gateway. Type ? for help.
```

```
de N7ML-7 (B,C,D,J,L,N,S,?) >
```

The first line is the user's connect request to your TNC. The second line is the connect message from the user's TNC. The third line is the greeting, and the fourth is the command prompt from the Gateway. The user sends a question mark, ?, to obtain the following help menu:

```
B(ye)          Log off gateway
C(onnect) n    Connect to station 'n'
C n STAY      Stay connected to gateway when 'n' disconnects
D(isconnect)  Cancel a connect attempt
J(heard)      Display stations heard
L(isten)      Toggle monitoring
N(odes)       Display nodes heard
S(end)        Broadcast unproto
de N7ML-7 (B,C,D,J,L,N,S,?) >
```

The commands' functions are:

B(ye) This is similar to the Bye command used in the Timewave MailDrop and BBS stations. When a user enters a **B** the Gateway will "disconnect."

C(onnect) n Similar in operation to the **CONNECT** command in the packet mode.

For a packet connection, the user may connect to your Gateway, then specify a string of digipeaters:

```
C W1AW VIA W2XY, W1XXZ
```

Your Gateway will try to establish a connection with W1AW as the destination; the user's call sign will be shown as the source, but with a difference: the user's SSID is decreased by one to avoid protocol conflicts on the same frequency.

Here is an example of the frames sent in establishing a typical connection (with the **MONITOR** command set to 5):

```
USER>GATE [C]
GATE>USER (UA)
GATE>USER [I]:
    +++ N7ML Gateway. Type ? for help.
    de GATE (B,C,D,J,L,N,S,?) >
USER>GATE (RR)
USER>GATE [I]:
    c remote
GATE>USER (RR)                USER-15>REMOTE [C]
                                REMOTE>USER-15 (UA)
GATE>USER [I]:
    +++ CONNECTED to REMOTE at GATE
USER>GATE (RR)
USER>GATE [I]:
    hello.
GATE>USER (RR)                USER-15>REMOTE [I]:
                                hello.
                                REMOTE>USER-15 (RR)
                                REMOTE>USER-15 [I]:
                                Yes?
GATE>USER [I]:                USER-15>REMOTE (RR)
    Yes?
USER>GATE (RR)
```

Once the connection is established with the destination station, the Gateway notifies the user that the connection has been made and then goes from the Command mode into the Converse mode. Now, whatever the user sends goes to the destination station as data instead of to the Gateway as a command.

Normally, when someone disconnects from your Gateway, no link will remain. However, if a user adds the word *STAY* as the last argument in a Connect request, (e.g., *Call sign STAY*), the user will remain connected to your Gateway after disconnecting from the destination station.

If the connect attempt to the destination station retries out or is busy, your Gateway sends the user a `Retry count exceeded` or `(Remote) busy` message, and remains connected to the user even if *STAY* wasn't entered.

D(isconnect) (To cancel a connect attempt.) Since the source station remains in the Command mode until the connection to the destination station is established, there's no need for the user to wait for your Gateway to cycle through a full number of retries to attempt a connection—the user can send your Gateway a Disconnect request, which cancels the Connect request the same way it would in a TNC's Command mode. (The user stays connected to your Gateway even if *STAY* wasn't used in the original Connect command.) The Disconnect command may be used at any time before the connection is established, regardless of any preceding commands.

Once a connection is established and your Gateway is in the Converse mode, the user can end the connection either by sending a `B(ye)` command to the destination station if that station supports it, or by issuing a Disconnect request to the user's own TNC. If the user disconnects from your Gateway this way, it will force your Gateway to disconnect the destination station.

J(heard) Your Gateway sends its MHEARD list to the user. A maximum of eighteen stations are kept in the JHEARD list. JHEARD is a command available only to stations connecting to you.

L(isten) The Gateway toggles monitoring on or off.

N(odes) Your Gateway sends the user a list of nodes heard. The format is the same as that of the JHEARD command, the difference being that a call sign is put in the Nodes list *only* if the monitored packet was a UI frame with a PID of CF (NET/ROM) or CD (IP). A maximum of ten stations are kept in the Nodes list. You clear the Nodes list and the MHEARD list simultaneously with the same command, `MHEARD %`.

S(end) Your Gateway responds with. . .

`+++ Sending. To end, type '='.`

. . . and sends all subsequent data in the broadcast format appropriate to the selected port's operating mode. The data characters are held until the user sends a `(RETURN)`, whereupon the held data is broadcast.

In all operating modes, the user can stop sending "unproto" by sending the "=" character—the Gateway will then issue a command prompt. The "=" character shouldn't be used within the user's broadcast text.

Digipeating

Sooner or later, you'll want to connect to a packet station that's beyond your immediate radio range or is inaccessible from your location. If a third packet station is on the air and both you and the station you want to talk to are in range of that third station, the third station can act as relay station for your packets—you

simply enter the digipeater routing path in your connect request. Here's a sketch that shows how digipeating can solve a simple problem:

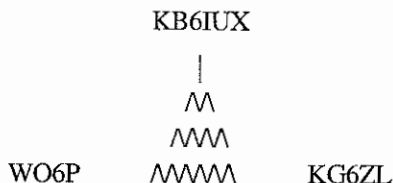

You're station WO6P and you want to have a packet QSO with KG6ZL, but there's a "cumulo-granite cloud" (mountain) between you that completely blocks your radio path. However, you know that there's a packet station, KB6IUX, that is accessible to *both* you and KG6ZL located on the mountain top.

To digipeat through (*VIA*) KB6IUX, enter:

```
cmd: C KG6ZL V KB6IUX
```

... but KB6IUX doesn't have *DFROM ON*, so no one can use him as a digipeater. What now? Pick up the telephone and call your friend at KG6ZL? Not necessarily. You listen some more and you can hear another station, KD7NM, off to the side of the mountain chatting with WF7A. WF7A is in a location where you know *he* can reach KG6ZL. So, you enter the linear, point-to-point path you need to use to connect to KG6ZL:

```
cmd: C KG6ZL V KD7NM,WF7A
```

They both have *DFROM ON*, so a few seconds later you receive an *ack* back from KG6ZL and you're all set.

Are You a Digipeater?

Your packet station can be a digipeater for other stations. You don't have to "do" anything—your PK-96 will digipeat other stations *unless you tell it not to* by using *DFROM*.

If your transmitter keys when you're not using it or during lulls in your own conversations, you're being used as a digipeater by someone. Don't worry—this won't interfere with your conversation. (As a courtesy, leave *DFROM ON*.)

If you want to see, or monitor, the text the other stations are sending through you, set *MDIGI ON*.

Identifying as a Digipeater

If your PK-96 is being used as the primary digipeater in a local area, you may want to enable *HID*—it will automatically identify your station for others to see.

You may also want to choose a simple identifier for others to use. You set it with *MYALIAS*. Examples are: SEA for Seattle; PTLT for Portland; LYNN for Lynnwood, and so on.

Time-stamping Packets and Messages

Monitored packets can be time-stamped if the PK-96's internal clock has been set with *DAYTIME*. To time-stamp monitored packets, turn *MSTAMP ON*. Turning *DAYSTAMP ON* adds the date to the time-stamp provided by *MSTAMP*.

Sometimes it is useful to know what time someone connected to you—perhaps for logging purposes. To time-stamp your packet connects and disconnects, turn *CONSTAMP ON*. As discussed in the last paragraph, turning *DAYSTAMP ON* will add the date to this time-stamp as well. The *DAYTIME* command must be set first for *DAYSTAMP* to operate.

Multiple Connection Operation

Because packet radio supports multiple QSOs on the same frequency, you can converse with more than one station at a given time. The PK-96 offers ten channels, (0-9), each of which can support a conversation. This capability is a powerful feature of your PK-96, and a mentally challenging one when you have more than a couple of QSOs going on at once!

Multiple connect operation is like a 10-line telephone with automatic "hold." When you're connected to multiple stations you automatically receive everything sent *to* you, but you must select the proper channel to send data to a particular station on a particular channel; in effect, it's just like having to push the proper "line" button on the telephone to talk to someone—you can't talk to someone on Line 1 while you're talking on Line 3.

As mentioned before, you can step down to Command mode while you're connected to someone, and you'll need to jump down there in order to change channels. (This is true for any and all of the channels that are active.)

NOTE:

The MAIL light will blink if the PK-96's receive buffer is filled. To keep the buffer from filling up quickly with "junk mail," set MONITOR to zero. To clear the mail buffer, you can either turn the PK-96 off and then on again, enter RESET, or let the PK-96's contents "dump" into your computer.

Setting Up

You can select any channel to initiate a connect, but to enable your PK-96 to allow *incoming* multiple connections, you need to set the USERS parameter to a value greater than one. The number you enter in the USERS command tells the PK-96 how many users you'll allow to connect to you at a given time. So, if you set USERS 5, five stations can connect to or digipeat through you at the same time. With USERS set to 0 (zero), no one can connect to or digipeat through you.

NOTE:

With all ten channels enabled with the USERS command, stations that connect with you will connect to the PK-96's channels in ascending order, starting from 0. Stations that connect to your MailDrop are automatically connected to your PK-96's Channel 9.

The Channel Switching Character

Once you've set the USERS command, you need to set the CHSWITCH character. Set it to a character that you don't normally type, such as the vertical bar "|" (ASCII \$7C) or the tilde "~" (ASCII \$7E). You'll use this character to tell your PK-96 that you want to change channels. To change channels, press the CHSWITCH character you just defined, and then a number from 0-9. For example, if your CHSWITCH character is the tilde, you're chatting with someone on Channel 0, and you want to chat with a station that connected to your PK-96's Channel 1, you'd enter:

```
cmd: ~1 (RETURN)
```

```
~1: cmd:
```

NOTE:

Even though you've changed to Channel 1, you can still access all the commands normally available to you that you had in Channel 0, the PK-96's default channel. This is true for all ten channels.

When you change channels, the channel you changed to will have the packet header information of the station that just connected to you. Remember that the text you'll now type will only be sent out to the station connected to the channel your PK-96 is currently on. If, while talking on Channel 1, the station still connected to you on Channel 0 sends data to you, it will be held in the PK-96's memory until you return to Channel 0, whereupon the data will scroll up on your screen.

Say, by coincidence, the station you're connected to sends a character which is the same one you've set for CHSWITCH. If you want to be able to tell the difference between the CHSWITCH characters you type and the same character from other station, set CHDOUBLE ON. This will cause all received CHSWITCH characters to appear double, while the ones that you type will appear only once.

CHCALL

Multiple connection operation can be confusing, especially when you're trying to remember who's connected on which channel. To help the situation, turn CHCALL ON to display the call sign of the station connected to you on a given channel number.

Checking Your Connect Status with CSTATUS

To check which channels are available to you as well as who's connected to you, enter CSTATUS. It will show you the connect status of all 10 packet channels—connected and unconnected—including the channel you're currently on. By entering CSTAT SHORT, the PK-96 will display only the channels that are currently connected.

Packet Meteor Scatter Extension

A new packet protocol extension has been added for meteor scatter work that allows a Master/Slave packet connection to be established. This is done to reduce the possibility of simultaneous transmissions by both sides of a packet connection over a long meteor scatter path. This experimental protocol is activated by turning UBIT 18 ON. The packet station that initiates a packet connect becomes the master station and the station that acknowledges the connect becomes the slave.

After a meteor scatter connection has been established, the master station continually sends either information frames (I-frames) or polling frames and awaits an acknowledgment from the slave. The Master station sends packets constantly, even if all its I-frames have been acknowledged. The slave station sends nothing, not even I-frames, until it receives a polling frame from the master. The slave station may only send an I-frame to the master after a poll frame has been received.

The packet timing of the master station is critical for proper meteor scatter operation. In a normal AX.25 packet connection, the FRACK timer counts down until it reaches zero and then a RETRY of a poll frame is sent. The FRACK timer counts in units of seconds, however, and a finer timing resolution is desirable for meteor scatter work. A new timer, called FRICK, has been added which times in 10 mS increments. The FRICK timer can be set from 0 (disabled) to 250 which corresponds to a time of up to 2.5 seconds.

The following settings are recommended for this method of meteor scatter work. Both packet stations should use the same settings:

```
UBIT 18 ON
RETRY 0
AX25L2V2 ON
MAXFRAME 1 (CHECK doesn't matter)
FRICK n, where n is large enough to allow the other station time to send the start of an acknowledgment frame.
```

NOTE:

Don't operate the unit with multiple packet connections while FRICK is active (1-250). In contrast to FRACK, which provides one retry timer per multi-connect channel, there is only one FRICK timer in the PK-96. Each logical channel will try to use the same FRICK timer, causing interference with the other channels.

Digipeaters shouldn't be used when in the meteor scatter mode. The FRICK timer (unlike FRACK) doesn't allow any extra time when digipeater stations are specified. To return to normal AX.25 packet operation, turn UBIT 18 *OFF*. Also, be sure to disable the FRICK timer (by setting FRICK to 0) when you're through operating in meteor scatter mode.

Intermediate and Advanced Commands

Your PK-96 has many commands that are not necessary for day-to-day connects or casual conversations. Still, as you become more familiar with packet, these commands and features may become important to you.

1200/9600 bps Operation

To select the speed you want to operate packet at, simply change the value of HBAUD—for 1200 bps packet, enter HBAUD 1200; for 9600 bps packet, enter HBAUD 9600.

Monitoring Other Stations

When you're connected, MCON determines what packets are shown. The default of MCON is 0 (zero) which tells the PK-96 *not* to monitor any packets while you're connected. Most users prefer it this way, so they're not disturbed with monitored channel data while they're connected with another station. However, if you want to monitor packets while connected, refer to MCON in *Chapter 4* for user settings.

Use the MONITOR command to determine what kinds of packets you'll see when you're *not* connected to any stations. The higher the argument number (1-6), the more information you'll see. If you don't want to see extraneous information associated with sent packets, use a lower value like 2 or 3.

NOTE:

If you'll be leaving your PK-96 on to accept connects from other stations while your computer is off, set MONITOR to 0 (zero). This way, the PK-96's buffer won't fill up with "junk" mail and its memory will be devoted to its MailDrop.

Monitoring the Packet Networking Switches

There are other types of frames used by networking switches that the PK-96 doesn't normally display. These frames can be seen with MPROTO—turning it on allows *all* AX.25 frames to be displayed. Some packets you might see with MPROTO *ON* will contain information that may interfere with the display on your computer, causing it to look "funny". For this reason, MPROTO's default is *OFF*.

Selective Monitoring

After you've monitored channel activity for awhile, you may decide there are only a few stations you want to copy. To "screen" stations for monitoring purposes, use MTO and MFROM. With the MBELL command, you can even be alerted when a certain station transmits on the frequency. These commands work in conjunction with MONITOR and MCON commands.

MFILTER

Some terminals and computer programs are sensitive to certain characters that may appear in monitored packets. You'll know this is happening if the cursor on your screen occasionally moves to strange places and causes the received copy to be garbled.

The PK-96 default for MFILTER is `$80`, which prevents most control characters from interfering with your display.

Monitor Without Call Sign Headers

Sometimes you may want to monitor certain stations without having to look at the packet call sign headers. This can be useful when monitoring message traffic from a large PBBS. The MBX command allows you to choose the call sign of a station, or a pair of stations, you want to monitor without having to see packet headers.

Beacon Operation

In the early days of packet, the beacon was useful to show your presence on the packet channel. With the growth of packet, many users feel that beacons have outlived their usefulness and interfere with traffic. Use your beacon with discretion.

The PK-96 can send an automatic "beacon" message at a specified time interval. A beacon can send special announcements or just let others know you're on the air. To enable beacon operation:

1. Enter your beacon message in BTEXT.
2. Set the beacon interval using the `BEACON EVERY` or `AFTER` command.
3. A beacon frame is sent to the path set in UNPROTO.

As a reminder, if you set the BEACON timing at a value considered too small for busy channels (less than "90"), you'll see:

```
WARNING: BEACON too often
```

Packet Transmit Timing

The PK-96 has a number of built-in timers used to control the packet protocol and transmit timing. The default values have been set at the factory, but they may not be the optimum values for your local area. Most protocol parameters should be adjusted only after reading about them later in the chapter. You *should* adjust TXDELAY for your transmitter as described below.

Radios vary in the time it takes it to switch from receive to transmit. If your PK-96 starts sending data before your transmitter is up to power, the packet will not be received properly at the distant end. TXDELAY controls the delay between your transmitter's key-up and the moment your PK-96 starts sending data. The default value of `30` corresponds to a time of 300 mS and works with most VHF/UHF FM transceivers. With modern transceivers, TXDELAY can often be reduced from its default value which will improve packet performance. You should perform the following procedure to optimize TXDELAY for your station:

- 1) Find another station who can reliably digipeat your signals.
- 2) Set your UNPROTO path to `TEST` via the call of the station that will digipeat your signals. For example: `U TEST V WO6P`.
- 3) Set MONITOR to at least `1`.
- 4) Go to Converse mode by entering `K`, then send a few packets by pressing the (RETURN) key. You should see the outgoing packets on your own screen echoed back as they're digipeated by the other station.

- 5) Start reducing TXDELAY by units of 5 each time, making sure the other station is still digipeating *all* of your UNPROTO packets.

Eventually you'll find a value where the other station can no longer copy your packets accurately enough to digipeat them. When this happens, increase TXDELAY in units of one or two until the other station digipeats *all* of your packets again. This will be the optimum setting of TXDELAY *for that particular radio*.

After TXDELAY has been adjusted, you may want to adjust the audio delay (AUDELAY) using the same procedure. (See AUDELAY in *Chapter 4* for more information.)

Packeting Through Voice Repeaters

Although it isn't common, packet can be used through voice repeaters. When sending packets through a repeater, you may require a longer key-up delay than is normally needed for direct communications. AXDELAY adds more key-up delay in your PK-96 so that the repeater can key-up at the proper time. AXHANG sets the time span needed for the repeater to "drop."

Although it's seldom needed, the PK-96 does have an input for squelch information from a transceiver through the RADIO connectors. This input should be used with the SQUELCH command.

Packet Formatting and Editing

Some of your PK-96's command parameters affect how your packets are formatted—how your typing appears to the rest of the world. Other commands let you correct typing errors before your packet is sent, cancel lines, or entire packets.

(RETURN)'s and Linefeeds

Most hams use packet radio for sending and receiving messages or conversation. The character used to send a packet is defined with the command SENDPAC which defaults to a (RETURN) (\$0D). You can change the SENDPAC character, but you'll find the (RETURN) or (ENTER) key to be a natural choice.

Similarly, your PK-96 will include a (RETURN) in the packet you send to the other station since this makes for a more natural conversation. ACRPACK controls this feature, though most people will never want to change this.

The PK-96 also has the capability of adding a linefeed character (\$0A) automatically to packets that you send to others. If you encounter a station or two that says your packets are overprinting, you may want to turn the ALFPACK or ILFPACK ON for them.

Cancelling Lines and Packets

Most of the time, (BACKSPACE) or (DELETE) is all that's needed to edit a line before it's sent. Occasionally it may be helpful to cancel a line or the entire packet you're entering with just one keystroke. The CANLINE character, (CTRL-X), will cancel the entire line you're typing; the CANPAC character, (CTRL-Y), will delete the entire packet.

Redisplaying Text

If you've erased and retyped lots of characters, you may want to see a "fresh" screen (especially if BKONDEL is OFF.) The REDISPLAY character (CTRL-R) will refresh your screen and will display any packets you might have received while you were typing.

The PASS Character

Sometimes you may want to include a special input character, such as a (RETURN), in a packet without forcing an action to happen. For example, to send several blank lines in the same packet, you must include a (RETURN) at the end of each line. However, when you press (RETURN), it normally forces a packet to

be sent. You can get around this problem using the **PASS** (CTRL-V) character. You can include any character in a packet (including all special characters) by prefixing that character with the **PASS** character. For example, if you're in Converse mode, you can type:

I wasn't at the meeting. (CTRL-V)+(RETURN)
What happened? (RETURN)

Without the **PASS** character, this message would go out as two separate packets because you entered two (RETURN)'s, but by prefixing the first (RETURN) with a (CTRL-V), you send all the above text in only one packet while maintaining its two-line format. The **PASS** character can be useful in formatting text messages, such as **CTEXT**, as well.

Packet Protocol Basics

Here we will talk a little about the AX.25 packet protocol. You don't need to understand this to use packet, but it is helpful in understanding some packet protocol parameters.

There are two modes of packet transmissions: connected and unconnected. Most of the time when you use packet, you'll be conversing with another packet station in a connected state. Still, the unconnected, or unprotocol, mode comes in handy for beacon transmissions and roundtable exchanges.

All packets are constructed basically the same: they contain source and destination call signs (and any digipeaters, if used) as well as information identifying the type of packet. (This packet identification can be seen with the **MONITOR** command discussed earlier.) All packets contain an error check code called the **CRC**. This ensures that it won't contain any errors when it is received. **PASSALL** can disable the **CRC** error check, but this should only be done for experimental purposes.

Connected Packets

When you connect to another station, the AX.25 packet protocol ensures that the station you're connected to receives all the packets that you send. Likewise, the protocol ensures you will receive all the packets the other station sends to you. The following describes briefly how the protocol does this.

FRACK and RETRY

When the PK-96 sends a packet to another station, it expects an *ack* packet back from the other station confirming that the packet was received. The AX.25 packet protocol will automatically retransmit (retry) packets when an acknowledgment isn't received from the distant end of the link within a specified time.

FRACK sets the time span before the originating station retransmits (retries) the packet that hasn't been *acked*.

RETRY sets the maximum number of retransmissions before your PK-96 "gives up" and terminates the connection attempt (disconnects). The **TRIES** counter keeps track of the retries that have occurred on the current packet.

PACLEN and MAXFRAME

Packets will be sent either when the (RETURN) is pressed or when the maximum packet size is exceeded—which is set by **PACLEN**. When large amounts of data need to be sent, **PACLEN** can be increased to *256*. When conditions are poor or the channel is crowded, this value should be reduced to *64* or less.

The packet protocol allows more than one frame to be sent in a single transmission, which is set by **MAXFRAME**. When conditions are good, up to 7 frames can be sent to speed data transfer. When conditions are poor or the channel is crowded, **MAXFRAME** should be reduced to *1*.

Reducing Errors through Collision Avoidance

Since packet operates over the radio, there are usually many stations operating on the same frequency that can't hear each other. The digipeaters and network nodes allow these stations to communicate with each other, which can increase the chances of collisions.

The first attempt to avoid collisions was through the use of the `DWAIT` and `RESPTIME` timers. `DWAIT` forced the TNC to delay the transmission of any packet except for digipeated frames by the time selected. This fixed timer helped, but packet was still plagued by collisions. `RESPTIME` was added to help with large file transfers. Still, more needed to be done to reduce collisions.

Another attempt to reduce collisions was the introduction of AX.25 version 2 protocol. Almost everyone on VHF packet uses version 2, which is controlled by the `AX25L2V2` command. This helps on VHF, but some users on HF packet turn this command off.

An exponentially distributed random wait method was proposed by Phil Karn (KA9Q) called P-persistent CSMA. When `PPERSIST` is `ON`, the PK-96 uses the number set in `PPERSIST` and the time value set by `SLOTTIME` to more randomly distribute the transmit wait time. This is more efficient than using the `DWAIT` time.

As a further attempt to improve performance, Eric Gustafson (N7CL) proposed giving priority to acknowledgment packets (acks); this protocol is controlled by `ACKPRIOR`. Check with the experienced packet users in your area and find out if they are using priority acknowledge or have changed any other parameters.

DAMA Support

Timewave has added DAMA (Demand Assigned Multiple Access) to the PK-96. DAMA allows for a master/slave connection to reduce packet collisions. At times, a node's receiver can hear too many signals at once and remote users can get lost in the noise. A good example of this situation is when ships on the open sea try, but can't connect to communication satellites; the stations have a clear shot at the satellite, yet can't connect.

To solve this problem using existing equipment and still using only one frequency, DAMA has been implemented to organize all node users' communications. With DAMA, the master station identifies all slave stations and polls each of them for information. Slave stations are 'asked' by the node if they have any information to send. If a slave station does, the information is sent and the node 'remembers' that this station sent information this time around. If a slave station does not send information, the master 'remembers' and skips this person next time around, coming back to them at a later time. Those stations replying with information when polled are considered active. Stations that do not send information are considered inactive. Active stations are given a higher priority than inactive stations and thus, more opportunity to send information. As the node traffic increases, inactive users fall down through the priority list. Low priority stations can become active (and have higher priority) at anytime by sending information when the master station polls. Using DAMA can increase overall channel throughput by organizing stations based on their state of activity. Stations sending data are given more chances to send data and stations not sending data are given less chances.

Timewave has added the `Uplink` command to the PK-96 for use with DAMA communications. Information on this command can be found in the "You're in Command" chapter of this manual.

CHECK and RELINK

If a station connects to you and then turns its TNC off, you would probably not want to stay connected to the station. The `CHECK` timer determines the amount of time your PK-96 will wait before testing the link if no data has been exchanged.

`RELINK` sets what happens *after* the `CHECK` timer has expired. If `RELINK` is `OFF`, the PK-96 will change to the disconnected state to terminate the link. If `ON`, the PK-96 will attempt to reconnect to the distant station to reestablish the link.

Transparent Mode

Transparent mode allows any 8-bit binary character to be sent by your packet station. Usually, you must use the Transparent mode to transfer binary and executable files to and from other stations.

You can either enter the Transparent mode by typing `TRANS` at the command prompt after you connect, or by setting `CONMODE` to `TRANS`. Either way, once you enter the transparent mode, any character you type will be sent automatically after the `PACTIME` setting. This way any character can be sent by the PK-96. Although we recommend using hardware flow control in Transparent mode, software flow control is available through the `TRFLOW` and `TXFLOW` commands.

To return to the Command mode after you're finished with transparent mode, you must type the Command character (`CTRL-C`) three times within the "guard time" set by `CMDTIME` (default: 1 second), then wait an additional `CMDTIME` for the `cmd:` prompt to appear.

Sometimes you may need to send a file that contains some 8-bit data, but you don't need all the features of the Transparent mode. In this case, you may find turning the command `8BITCONV ON` is all that is needed.

Full-Duplex Operation

Most packet activity is conducted through half-duplex transceivers that transmit or receive, but not both at once. In some systems where a separate transceiver and receiver is used (such as satellite operation), set `FULLDUP ON`.

Morse ID in Packet

In most countries, packet is an accepted mode of identification so `MID` should be left `OFF`. (Your call sign appears in the header information.) If a Morse ID is required where you reside, turn `MID ON`.

The QRA Feature

The PK-96 recognizes UI frames with a destination field of "QRA" and will respond by sending an ID packet. This is helpful for others new to your area that are looking for other packet stations to talk to. To disable this feature and remain anonymous, simply set `UBIT 22 OFF`.

If you want to see who's available in your local area, simply set your `UNPROTO` path to `QRA` and send a packet. Within 1 to 16 seconds, other stations should respond to your QRA request by sending an ID packet of their own. This feature is compatible with TAPR's QRA feature introduced in their 1.1.8 firmware release.

Packet Mail

Although standard TNCs allow incoming messages to be saved, there's no way for the owner to leave a message for someone who will connect at a future time. The ability to both send and receive messages without the owner being present is accomplished by a mailbox.

There are many different packet mailbox systems in use. Some systems are large and require the use of a dedicated computer. Other systems are small, like the personal MailDrop built into your PK-96.

Large systems are often called Packet Bulletin Board Systems (PBBS) since they serve as electronic message centers for a local area. PBBS's are a source of information as well as a gateway for messages that can be sent to, and received from, other parts of the country or world. You will probably want to locate the PBBS nearest you and connect to it from time to time.

Most mailbox systems are easy to use and, whether they are small or large, operate in much the same way. Another nice feature of mailboxes and other automatic systems is that they usually have a `Help` file or menu available to the caller by entering an "H" or "?" after a command line. Feel free to experiment with mailboxes and other packet systems, but be courteous and experiment during off-peak hours.

For more information on setting up and using your MailDrop, read *Chapter 6 MailDrop Operation*.

6. MailDrop Operation

Overview

The PK-96's MailDrop acts like a small post office—it uses a subset of the well-known WORLI/WA7MBL packet BBS commands to send and receive messages manually or automatically. Not only can you originate and receive messages, but with 3RDPARTY ON, you can accept and relay messages left for others.

The MailDrop also supports forwarding and reverse-forwarding of packet messages if properly coordinated with a local or “full service” BBS. This means that your station can receive messages from that BBS, hold or send them on to their recipients, then return replies later after they've been answered. Hierarchical message addressing is now supported to simplify the routing of both national and international traffic.

NOTE:

You needn't have your computer on for your PK-96's MailDrop to function, but you must leave your radio on to allow other stations to access your MailDrop, or if you want to record the radio traffic the PK-96 hears.

MailDrop Memory

The number “*n* free” is the RAM space available for MailDrop messages. As your MailDrop fills with messages, the RAM space will decrease until there isn't any space left for messages or other activities. When this happens, the MAIL light will blink on the front panel of the PK-96 to let you know that all the RAM memory has been used up. If someone tries to connect to your station when this happens, they'll get:

```
*** (your call sign) busy - DISCONNECTED
```

... and will be automatically disconnected from your station.

Along these lines, while you're logged on to your own MailDrop, if a station issues a connect request to your PK-96 and it won't let it connect—it will display the message:

```
*** (your call sign) busy
```

However, once you're finished using your MailDrop—by entering *B* for *Bye*—your MailDrop will be available to other stations.

When users connect to your MailDrop, they automatically connect to channel 9.

Setting Up Your MailDrop

Simply enter MAILDROP ON to enable MailDrop operation.

When operating in packet, your MailDrop can have its own call sign, which you enter in MYMAIL. Common practice is to add an SSID after your call sign for this purpose, usually -1. If you don't enter a call sign in MYMAIL, the MailDrop will use the call sign that you entered for MYCALL and all incoming connections will connect automatically to the MailDrop.

By the way, you have full control of your PK-96 while your MailDrop is on. You can connect to, and chat with, other stations while someone is using your MailDrop, provided the user has connected to the call you entered in MYMAIL.

It's a good idea to enter a CTEXT message that says that if you don't answer the user should reconnect to your MailDrop through your MYMAIL call sign. An example would be:

```
cmd: CTEXT Hi! I'm not available right now, so please reconnect to WF7A-1 to leave a
message in my MailDrop. '73...Rich.
```

CText was

```
CText now Hi! I'm not available right now, so please reconnect to
WF7A-1 to leave a message in my MailDrop. '73...Rich.
```

Accessing and Commanding Your MailDrop

You must not be connected to any other stations when you access your own MailDrop. To check that you're "clear," enter MDCHECK. If someone is connected to your PK-96, you'll get the message: ?not while connected. If you're clear, you'll see:

```
[AEA PK-96] 19712 free (B,E,K,L,R,S) >
```

NOTE:

The amount of free RAM available varies upon how much mail you already have stored in your mailbox and whether or not you have the expanded mailbox option installed.

Console Commands

B, E, K, L, R, S are the Maildrop commands available to you as the "console" operator. The commands mean:

B(ye)	Log off from the MailDrop
E(dit)	Edit a MailDrop message
K(ill) <i>n</i>	Kill (delete) message number <i>n</i>
L(ist)	List the message directory
R(ead) <i>n</i>	Read a specific message <i>n</i>
S(end) <i>call</i>	Send a message to a particular call sign

If you enter any command besides these six letters, you'll get the error message:

```
*** What?
```

Monitoring Your MailDrop

Set MDMON *ON* to monitor another stations' usage of your MailDrop. It will show you both sides of the MailDrop QSO with your station. (Packet headers aren't shown while a user is connected to your MailDrop.) Conversely, turn MDMON *OFF* to cancel MailDrop monitoring. UBIT *13* allows MailDrop connect and status messages to be disabled as well. (See UBIT *13* for more information.)

MailDrop Prompts and Operation

MTEXT is the MailDrop connect-message prompt sent to a user that's connected to your MailDrop. The default message is:

```
Welcome to my AEA PK-96 MailDrop.
Type H for help.
```

You can change it to your liking. For example:

```
cmd: MTEXT You've reached KG6ZL's mailbox. If you need help, enter H.
```

```
MTEText was Welcome to my AEA PK-96 MailDrop.
Type H for help.
```

```
MTEText now You've reached KG6ZL's mailbox. If you need help, type
H.>
```

```
cmd:
```

You must set MMSG ON for your MailDrop's "welcome message" to be sent.

The MDPROMPT prompt message follows right after the Send command is entered. The default message is:

```
Subject:/Enter message, ^Z (CTRL-Z) or /EX to end
```

MDPROMPT is comprised of two different prompts that are sent to the connected station. The first prompt is simply "Subject:". When the connected station enters the subject of his message (max. 27 characters), the second prompt will appear:

```
Enter message, ^Z (CTRL-Z) or /EX to end
```

You can enter any text in MDPROMPT, up to a total length of 80 characters for both prompts; both parts of the prompts must be separated by a forward slash (/) as shown—before the slash is your "Subject" line, and after the slash is the "Enter message" line.

MailDrop Command Summary

When someone logs onto your MailDrop, the following commands will be available:

```
A, B, H, J, K, L, R, S, V, ?
```

Here's what they mean:

A(bort)	Aborts the reading of a message
B(ye)	Log off from your MailDrop
H(elp)	Help for the MailDrop commands
J(log)	Sends the PK-96's MHEARD list
K(ill)	Kill or delete messages
L(ist)	List the message directory
R(ead) n	Read a specific message numbered "n"
S(end) n	Send a message numbered "n"
V(ersion)	Sends the PK-96's sign-on message
?	Help for the MailDrop commands [same as H(elp)]

- A(bort) This is handy if the user decides not to continue reading a long message or a list. The message, *** Done, followed by the MailDrop prompt will be sent after an "A" has been received. Although *you* can't use the Abort command, you can use (CTRL-X) to do the same thing.
- B(ye) Logs you—or the calling station—off the MailDrop. As the console operator, you'll see the standard cmd: prompt; a calling station will be simply disconnected.
- E(dit) # Available to the SYSOP only, Edit controls the status of the messages in your MailDrop; you must access the MailDrop before typing this command. Here are all the possible ways to use Edit:

E lists the following short help file:

```
E msg#
E msg# B/T/P
E msg# Y/N/F
E msg# >/</@ call sign
```

Examples:

```
E 12          Shows message #12's information line.
E 23 > WF7A  Sets WF7A as message #23's destination.
E 35 < WF7A  Sets WF7A as message #35's source.
E 48 @ WF7A  Sets WF7A as message #48's destination BBS.
E 49 @ KG6ZL.MT.USA.NA
                Sets KG6ZL as message #49's destination BBS and adds the hierarchi-
                cal forwarding information, .MT.USA.NA, which directs the message to
                the KG6ZL BBS located in the state of Montana (MT) in the United
                States, North America (NA) continent.
E 58 @          Clears message #58's destination BBS field.
E 60 P          Sets message #60's status to Private.
E 61 B          Sets message #61's status to Bulletin.
E 62 T          Sets message #62's status to Traffic.
E 63 Y          Sets message #63's status to Has-Been-Read.
E 64 N          Sets message #64's status to Has-Not-Been-Read.
E 49 F          Sets message #49's status to Reverse-Forward.
```

The command *E # F* sets the message status to enable reverse-forwarding of a message number. To cancel forwarding, set the status to either *Y* or *N*. Please read the section on reverse-forwarding later in this chapter if you're interested in this feature.

- H(elp) This command, available to the user only, sends a list of all available MailDrop help commands. A question mark will also cause the HELP file to be sent.
- A(bort) Stop Read or List
- ```
B(ye) Log off
H(elp) Display this message
J(log) Display stations heard
K(ill) K n: Kill message number n
```

KM: Kill messages you have read  
 L(ist) L: List message titles  
 LM: List messages to you  
 R(ead) R n: Read message number n  
 RM : Read messages to you  
 S(end) S: Send a message to console operator  
 S n: Send a message to station n  
 V(ersion) Display TNC firmware version  
 ? Same as H(elp)

J(log) Another command available only to the user, "J" will cause your MailDrop to send your PK-96's MHEARD list. (This command isn't available to you as the console operator since you can simply enter MHEARD in the command mode to obtain the same list.)

K(ill) n "K n" deletes message number "n" from the MailDrop. As console operator, you can kill any message. A user can kill only messages addressed to (or from) that station. The user may enter KM [(K)ill (M)ine] to delete all of the messages that have been previously read.

L(ist) Shows you, the console operator, a list of all active messages on the MailDrop. The list is preceded by the following column header:

```
Msg# Size To From @ BBS Date Time Title
```

All active messages are listed under this line with the most recent message first. DAYTIME must be set for the Date and Time information to appear. If DAYTIME isn't set, periods will appear under the Date and Time fields.

When a user enters the List command, the MailDrop lists only the messages that particular user is allowed to read, including messages addressed to ALL and QST; messages to other users aren't displayed. The MailDrop also accepts the LM (List Mine) command from the user. This shows messages addressed only to that particular user, not messages addressed as ALL, QST, or Bulletins.

R(ead) n This command displays the header and text of message number "n". Messages are read by number, not call sign. As console operator, you can read all messages. A user may read only messages addressed to his call sign, or to ALL, QST, or Bulletins.

The MailDrop accepts the RM (Read Mine) command from users. This command acts only on messages addressed to the user, not messages addressed to ALL or QST. RM displays only messages that haven't been read.

S(end) The S (call sign) command notifies the MailDrop that either you, as console operator, or the user wants to send a message.

With 3RDPARTY ON, the connected station can leave a message for another station or to you. However, if you have 3RDPARTY OFF, then the calling station will see:

```
*** No 3rd party traffic
```

```
[AEA PK-96] 18396 free (A, B, H, J, K, L, R, S, V, ?) >
```

See the next section, *Sending Mail*, for information on how to send mail.

|           |                                                                                                           |
|-----------|-----------------------------------------------------------------------------------------------------------|
| V(ersion) | This user command causes the PK-96 to send the sign-on message and its firmware date.                     |
| ? (H)elp  | Another user-only command, "?" sends the user the same list of MailDrop commands as the "H" command does. |

## Sending Mail

### From the Console Operator

To send mail, you have to log onto your MailDrop by entering *MDC* (MDCHECK). When you do, you'll see the following:

```
cmd: MDC
[AEA PK-96] 19712 free (B,E,K,L,R,S) >
```

Enter *S* (*call*) of the station you want to send mail to. If you want to send mail to KB6IUX, enter:

```
S KB6IUX
Subject:
```

Type in a subject line (max. 27 characters), then press (RETURN). You'll then be prompted with:

```
Enter message, ^Z (CTRL-Z) or /EX to end
```

Go ahead and enter your message; you can either have the PK-96 "wrap" your text as you reach the end of the line or press (RETURN) to go to the next line. You won't have text that breaks in the middle of a word if you use a (RETURN) to start a new line.

When you've finished writing your message, press the (RETURN) key and enter either a (CTRL-Z)+(RETURN), or /EX on a new line to end the message. The MailDrop prompt should then appear, saying: Message stored as #*n*. It will be then ready to accept your next command.

After ending the message, if you or the calling party see the message \*\*\* No free memory, this means that the message was too large for the available MailDrop memory and wasn't recorded. If this occurs, you must delete stored mail or re-enter the shortened message to fit into the available memory space.

---

#### NOTE:

*When logged on from your keyboard, if you use the "S" command without a call sign, you'll see the error message \*\*\* Need call sign. However, when calling stations use "S" without a call sign, the message will go to you, the console operator.*

---

As soon as a calling station uses "S" to send you (the console operator) a message, the STA light starts blinking to let you know that a message has been left for you. When you log on to your MailDrop, the STA light will stop blinking.

### Sending Other Types of Messages

Each message in the PK-96's MailDrop has a flag to show whether it's designated as Private, Traffic or a Bulletin. A "P," "T," or "B" after the message number shows the status of every message. A user sets this with the SP, ST, and SB forms of the Send command. You can change or set the status of these messages using the Edit (E) command described above. If only "S" is used as the Send command, the MailDrop will assign the message a Private (P) status.

The MailDrop also accepts Send commands in the form *SP console operator < WIAW*. The call sign after the "<" goes into the "From" field of the message header.



For example, your MailDrop accepts the following additional information in a Send command:

```
S KG6ZL @ KB6IUX.CA.USA.NA < WF7A
```

This means you're going to send a message to KG6ZL at the KB6IUX BBS in California, USA, North America, and that the message is from WF7A.

The MailDrop also supports BIDs (Bulletin IDs); this support is required for reverse-forwarding. The BID begins with a "\$" character and is sent and received in the Send command line:

```
S KB6IUX @ KG6ZL < WF7A $345_WO6P
```

This means you're sending a message to KB6IUX, who uses the KG6ZL BBS; the message is from WF7A and it's bulletin #345 from WO6P.

With the MailDrop, you can also use just the "\$" all by itself as shown in the two examples below:

```
S KB6IUX @ KG6ZL < WF7A $
```

...or

```
S ALL $
```

With the "\$" sign, the MailDrop will assign its own BID to these messages.

## From the User's Point of View

Assume that your MailDrop (MYMAIL) call is KB6IUX-1 and WO6P wants to connect to it. During his session with your MailDrop, he wants to list your MailDrop's messages, see if there's a message from you, read it if it exists, delete it after he's done reading it, send a return message to you, then finally disconnect from your MailDrop.

From his cmd: prompt, he'll type the usual connect request. He'll see this:

```
cmd: C KB6IUX-1
*** CONNECTED to KB6IUX-1
You have mail.
[AEA PK-96] 16508 free (A,B,H,J,K,L,R,S,V,?) >
```

The "You have mail" message informs WO6P that there's mail waiting for him. He types "L" to list all the current messages in the MailDrop.

```
[AEA PK-96] 16508 free (A,B,H,J,K,L,R,S,V,?) >
L
Msg# Size To From @ BBS Date Time Title
6 PN184 WO6P KB6IUX WF7A 24-Nov-94 20:15 Gobble!
5 BY287 ALL KB6IUX 21-Nov-94 18:42 Question
4 BY178 QST KB6IUX 19-Nov-94 17:30 Mailbox
1 BY 56 ALL KB6IUX 23-Nov-94 10:22 APLINK
[AEA PK-96] 16508 free (A,B,H,J,K,L,R,S,V,?) >
```

He sees the list of messages and the one in particular that's addressed to him. He types "R 6" to (R)ead MSG# 6.

```
[AEA PK-96] 16508 free (A,B,H,J,K,L,R,S,V,?) >
R 6
Msg#Size To From @ BBS DateTime Title
6 PN184 WO6P KB6IUX WF7A 24-Nov-94 20:15 Gobble!
Happy Thanksgiving, guy! Knowing that you're cooking the big meal for your
family tonight, should I rush a case of Pepto-Bismol over to you now?
73, Rich.
[AEA PK-96] 16508 free (A,B,H,J,K,L,R,S,V,?) >
```

He's read your message and now he wants to (K)ill it. He types:

```
[AEA PK-96] 16508 free (A,B,H,J,K,L,R,S,V,?) >
K 6
*** Done.
[AEA PK-96] 16580 free (A,B,H,J,K,L,R,S,V,?) >
```

He's killed the message and wants to send a reply back to KB6IUX (you). We'll continue from where he left off.

---

**NOTE:**

*As a habit, look to see if enough memory remains for the length of message you intend to send.*

---

```
[AEA PK-96] 16580 free (A,B,H,J,K,L,R,S,V,?) >
S
```

Without a call sign, the MailDrop will address the message to the MYMAIL call sign unless your MYMAIL call sign wasn't entered—then it would go to your MYCALL call sign. Messages sent with the "S" command are sent (P)ivate unless they are sent to "ALL" or "QST."

Subject:

*Hey, wise guy...*

Enter message, ^Z (CTRL-Z) or /EX to end  
 ...will you be the only turkey at your table?

See you later, and all the best to you and Audrey.

(CTRL-Z)

Message stored as #7

```
[AEA PK-96] 16427 free (A,B,H,J,K,L,R,S,V,?) >
B
```

```
*** DISCONNECTED: KB6IUX-1
```

---

**NOTE:**

*If the message was ended with a "/EX", the last line in the letter will have "/E" automatically inserted. To avoid having /EX inserted, use (CTRL-Z) to end messages.*

---

## The Console operator's Point of View

Here is a transcription of the above example exactly as it would appear to you if you have MDMON ON.

```
WO6P*>KB6IUX [C]
```

```
*** CONNECTED to WO6P (MailDrop)
```

```
Type H for help.
```

```
You have mail.
```

```
[AEA PK-96] 16508 free (A,B,H,J,K,L,R,S,V,?) >
```

```
L
```

| Msg# | Size  | To   | From   | @ BBS | Date Time       | Title    |
|------|-------|------|--------|-------|-----------------|----------|
| 6    | PN184 | WO6P | KB6IUX |       | 24-Nov-94 20:15 | Gobble!  |
| 5    | BY287 | ALL  | KB6IUX |       | 21-Nov-94 18:42 | Question |
| 4    | BY178 | QST  | KB6IUX |       | 19-Nov-94 17:30 | Mailbox  |
| 1    | BY56  | ALL  | KB6IUX |       | 23-Nov-94 10:22 | APLINK   |

[AEA PK-96] 16508 free (A,B,H,J,K,L,R,S,V,?) >

R 6

| Msg# | Size  | To   | From   | @ BBS | Date Time       | Title   |
|------|-------|------|--------|-------|-----------------|---------|
| 6    | PN184 | WO6P | KB6IUX | WF7A  | 24-Nov-94 20:15 | Gobble! |

Happy Thanksgiving, guy! Knowing that you're cooking the big meal for your family tonight, should I rush a case of Pepto-Bismol over to you now?

73, Rich.

[AEA PK-96] 16508 free (A,B,H,J,K,L,R,S,V,?) >

K 6

\*\*\* Done.

[AEA PK-96] 16760 free (A,B,H,J,K,L,R,S,V,?) >

S

Subject:

Hey, wise guy...

Enter message, ^Z (CTRL-Z) or /EX to end

...will you be the only turkey at your table?

See you later, and all the best to you and Audrey.

[AEA PK-96] 16534 free (A,B,H,J,K,L,R,S,V,?) >

B

\*\*\* DISCONNECTED: WO6P

## Message Numbers

Every message that's sent to the MailDrop is given a message number. Message numbers start at 1 and increase, one by one, to 999; after 999, the next message will start at "1" again. If you need or want to, you can reset the message counter using the LASTMSG command—just enter LASTMSG 0. The next message entered after this command will be numbered, "1." If you enter a LASTMSG number other than zero, the next message will be assigned the number immediately following the value you entered. For example, if you enter: LASTMSG 100, the next message entered into your MailDrop will be number 101.

## Forwarding and Reverse-Forwarding

Forwarding allows your local full-service Bulletin Board System (BBS) to automatically connect to your MailDrop to leave mail. Likewise, reverse-forwarding allows your BBS to connect to your MailDrop to retrieve mail left at your station. These operations are done automatically if the correct commands are enabled in your PK-96 and the mail in your MailDrop is assigned the correct coding.

Forwarding and reverse-forwarding (or auto-forwarding) can be an advantage in a metropolitan area. The BBS can be set to connect to your MailDrop at times when local traffic is low, such as late at night or very early in the morning when packet traffic is light.

Auto-forwarding requires the cooperation of both you and your BBS "SYSOP," because not all large BBSs will forward mail to individual users. Some packet frequencies are so busy with BBSs forwarding mail to other BBSs that they can't forward mail to individuals. Contact the BBS SYSOP to determine the guidelines in your area.

## Settings for Auto-Forwarding

For auto-forwarding to work:

1. Enter your MYCALL (and MYMAIL call sign if you want to use a separate call sign for your MailDrop.)
2. Make arrangements with your local BBS operator to auto-forward mail to your MailDrop. Make sure you let him know the MailDrop's call sign.
3. Enter the call sign of the BBS in HOMEBBS.
4. Set MONITOR to 0 so the PK-96's buffer will record only messages addressed to—or passed through—it and won't fill up with idle radio traffic.
5. Leave your PK-96 and radio on and set to the appropriate frequency so that the BBS can connect to your MailDrop. If your packet station isn't on when the BBS tries to connect, mail won't be forwarded and its SYSOP will mutter unprintable things.

## Entering a Message for Reverse Forwarding

With reverse-forwarding, the local BBS can retrieve mail from your MailDrop—entered by you or left by other stations—automatically and send it on the way to its final destination. To create a message that will be reverse-forwarded:

1. Enter MDCHECK to access your MailDrop from your computer.
2. After entering the Send command and the recipient's call sign, using the "@" field to set the destination BBS where the recipient of the message will pick up his mail. For example, if you want to send a message to KB6IUX, who you know uses KG6ZL's BBS, enter the following:

```
S KB6IUX @ KG6ZL.CA.USA.NOAM
```

---

**NOTE:**

*The call following the "@" sign doesn't need to be the same as the HOMEBBS call sign.*

---

The ".CA.USA.NOAM" is optional hierarchical forwarding information that, in this case, designates that KG6ZL is located in California in North America.

3. Enter the Subject and text of the message as you normally would. Don't forget to end your message with a (CTRL-Z) or "/EX".
4. After you're finished, log off from your MailDrop by entering B.

To readdress a letter already in your MailDrop for reverse-forwarding:

1. Use the Edit command to set the forwarding flag for *each message* that will be reverse-forwarded to the call sign in HOMEBBS. For example, to mark message number 53 for reverse-forwarding, type:  
E 53 F
2. After you're finished, log off from your MailDrop using B.

---

**NOTE:**

*If you want a message to be deleted from your MailDrop after it has been reverse-forwarded, leave KILONFWD ON; if you want to keep the message after it has been forwarded, leave KILONFWD OFF.*

*With KILONFWD OFF, after the message has been forwarded the message's flag will change from "F" to "Y" to show that it has been read and sent.*

---

# 7. GPS Operation

## Overview

This chapter describes how to configure and connect your TNC for GPS operation.

### Why do GPS in the PK-96?

All Timewave TNCs can run with Automatic Packet Reporting System (APRS™) software. The PK-96, however, has special firmware which makes Stand Alone Tracking and Ultimeter II® compatibility possible. Timewave also offers an APRS Adapter Cable for the PK-96 which makes Hardware Single Port Mode (HSP) operation possible.

The PK-96 contains special GPS features not found in other packet Terminal Node Controllers. The PK-96 can detect whether or not a GPS receiver is connected with the **GPSAuto** command, it then chooses the appropriate **GPSMode** of operation. If a GPS receiver is detected upon power-up, the PK-96 automatically sends a GPS initialization string. The PK-96 can be remotely polled by addressing a packet to its **GPOLLCall**, or by the polling features in APRS. The PK-96's GPS commands can be remotely programmed using the **GREMprog** command which is very convenient in Stand Alone Tracking applications—the unit never needs to be taken out of the vehicle to change GPS settings. GPS receivers can be remotely programmed via the PK-96. The PK-96's internal time and date can be set from the information obtained from the GPS receiver. There are provisions for an external input to cause the sending of NMEA strings, such as from a radio control head button. The PK-96 can even operate packet and GPS at the same time using the commercial mode. See the *You're in Command* chapter, G section for GPS commands.

### What is APRS?

Timewave has included a copy of APRS in your PK-96 packaging so you can experiment with it. Automatic Packet Reporting System (APRS™) is a copyrighted software program developed by Bob Bruninga (WB4APR), which is distributed as shareware for real-time Packet communications. The software keeps lists of stations heard and displays the locations of stations visually on a computerized map like the one in Figure 1. The maps can be scaled from .5 to 2000 miles. Few of the maps are complete, however, there are tracking features built into APRS which allow you to create maps just by driving down the streets of your town. Amateur operators all over the country are creating maps which can be downloaded from on-line systems for use by all. Stations can appear on the maps and each station may be given a symbol such as a house, car, or boat. The real benefit of using APRS software is in mobile tracking applications. Vehicles and people can be tracked and mapped using APRS. APRS also includes the ability to send short messages and bulletins. Using Ultimeter II weather information can also be shown on the computerized maps.

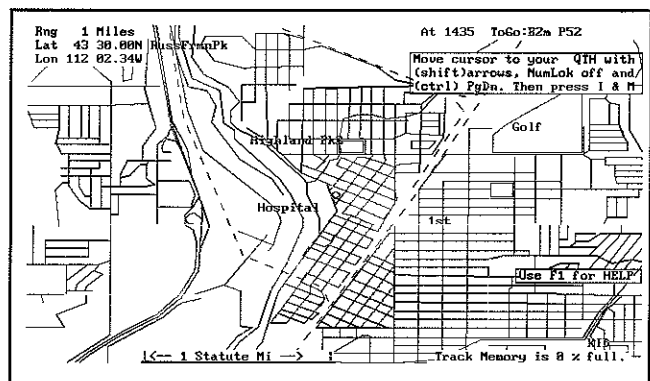

FIGURE 1: APRS computerized map

## Hardware Configurations

There are four different hardware configurations you can use when operating within an APRS system, each for a different purpose:

**1. A computer running APRS, a GPS receiver, a PK-96, an APRS Adapter Cable (optional), and a radio:**

This complete configuration allows you to track all users on the system in your area (including yourself), and send/receive messages and bulletins. Using Timewave's APRS Adapter Cable, you can connect a GPS receiver and a PK-96 to a single COM port on a computer running APRS, see Figure 2. Without Timewave's APRS Adapter Cable, the PK-96 and GPS receiver would need to be connected to separate computer COM ports. Having two COM ports free on most computers is a luxury most of us don't have with all the Windows related equipment such as mice and other serial peripherals. Mobile laptop computer users need the APRS Adapter Cable because most only have one COM port.

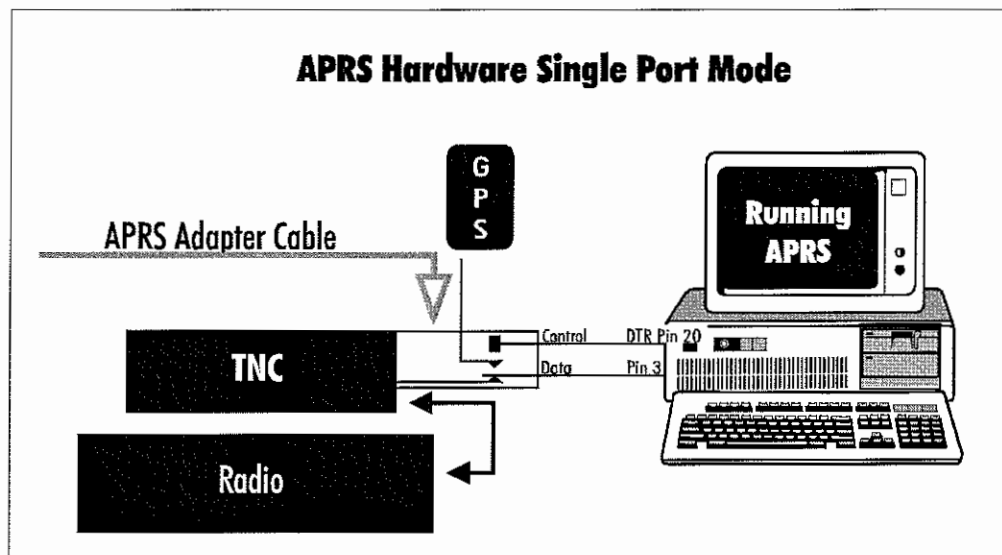

FIGURE 2: APRS HSP mode where APRS controls the cable switching between the TNC and GPS receiver

**2. A computer running APRS software, any AEA TNC, and a radio (No GPS receiver):**

This configuration lets you track all users on the system with your location being entered manually. This also lets you send and receive messages within APRS. All Timewave TNCs can be part of a system such as this. This configuration allows anyone with any Timewave TNC who is running APRS software in their computer to take part in this GPS technology. You don't need a GPS receiver to pull down location information from the satellites because you enter your position manually on the APRS computerized map, which in most cases is fine because you are at your house which doesn't (shouldn't) move. The only time you really need a GPS receiver is when you are operating packet while mobile because manually updating your position while mobile isn't practical—you need the GPS receiver to pull in those satellite location signals and update your position as you move.

**3. A PK-96, a GPS receiver, and a radio (No PC):**

This trio allows you to transmit your location automatically to others in an APRS system without having a computer in the vehicle. This is known as a Stand Alone Tracking Device because others can track your motion without you having to run APRS or even have a computer. The firmware in the PK-96 allows the TNC to parse the incoming location information from the GPS receiver (without the use of a computer running APRS which usually does the parsing) and then beacon the information over the ham bands.

Because the PK-96 can work both as a stand alone tracking device and as a connected APRS component, this TNC can be of aid in natural disaster situations, during public service events, and search and rescue missions, among other things.

For example, in a marathon, a pace car, ambulances, and other support vehicles could each have a PK-96 acting as a Stand Alone Tracking Device. A coordinator can be in a centralized location using a PK-96, radio, and an APRS Adapter Cable (optional) to connect with a computer running APRS software to visually track the vehicles. When an emergency arises, such as an injured runner, the coordinator can see which ambulance is closest to the scene and dispatch it appropriately through voice communications.

Further, if all vehicles in the previous example were equipped with a PC running APRS, a PK-96, a GPS receiver, a radio, and an APRS Adapter Cable, the coordinator could not only see where the vehicles were - he could dispatch them directly through the APRS system. The drivers of the vehicles would receive short messages from the coordinator such as, "Runner down, 4th and Main. Vehicle 2 respond." These short messages appear on the individual driver's computer screen much like typical packet messages. The messages can also be accompanied by computer 'beeps' to alert the driver to an incoming message. APRS includes a bulletin feature where all vehicles could receive messages simultaneously such as, "Take lunch."

#### 4. PK-96, ULTIMETER II, and a radio (No PC):

This configuration requires an Peet Bros. ULTIMETER II home weather station, see Figure 3 below. (Information on ULTIMETER II weather station packages can be obtained by calling 1-800-USA-PEET.) In case you are not familiar with ULTIMETER II, it is a weather station package including a control panel into which a thermometer, wind gauge, and an optional rain gauge are connected. If you like, you can monitor the temperature of any room in your home, keep track of temperatures in a greenhouse or out-building, or set alarm limits on a freezer or other appliances.

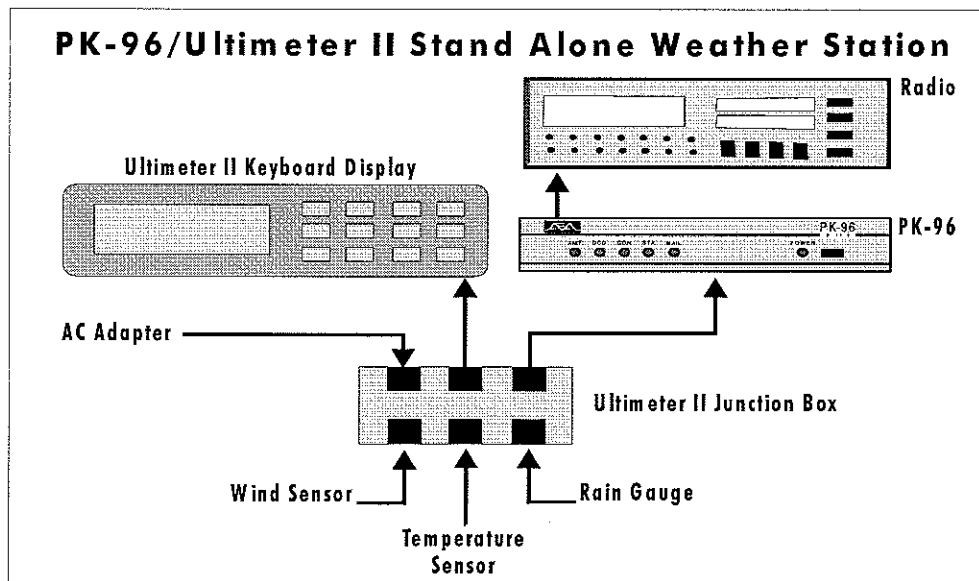

FIGURE 3: Illustrates components of a stand alone packet weather station

The PK-96 can be connected to the ULTIMETER II weather station, interpret the weather data, and transmit the weather and location information in packet so other APRS users can see your location and the weather at your location. The remote polling features of the PK-96 make it easy to set up a weather station in a remote location and receive the remote weather data via APRS at your house, office, or wherever. While at work, you can keep track of the weather situation at your home (inside or outside temperatures—whichever you prefer). Farmers can keep apprised of rain, wind, and temperature at a remote field site. In addition, several weather stations set up in your region can provide you with a comprehensive weather pic-

ture of your area—available to you and all other users at anytime. The PK-96, ULTIMETER II, and APRS add a whole new dimension to packet radio—we hope you experiment with this new application. Set-up procedures for an Ultimeter II packet weather station are discussed later in this chapter.

---

## Installing APRS

Timewave has included a disk containing PC PakRatt Lite and APRS. For your convenience, we have included an installation utility on the disk called INSTAPRS.BAT.

### To install APRS on your hard drive perform the following steps:

1. Type **MD APRS**, then press ENTER.
2. Type **CD APRS**, then press ENTER.
3. Type **A:INSTAPRS C:\APRS**, then press ENTER. (where A: designates the floppy drive with your master diskette, and C:\APRS is the full drive and path name of the destination hard disk drive and subdirectory.)

### Getting started:

- a. Type **APRS66** at the command prompt.
- b. Give your callsign and other info as prompted.
- c. Move the cursor to your exact QTH using the arrow keys and PgDn keys.
- d. Press **I** (Input), then **M** (My-position), and answer the questions.

At this point, APRS will begin beaconing your location and displaying other people's locations on the screen.

Ask around your local amateur community to find a frequency operating APRS in your area. Also, you might ask where to find additional, detailed maps of your area other people have created.

In the C:\APRS\README directory, there are a vast number of text files that explain how APRS works. Registration information is also contained in the readme files, information you will need if you want to set up an APRS weather station or operate Hardware Single Port Mode. Timewave does not provide technical support for APRS, however, we do provide support for PC PakRatt Lite.

---

## Setting Up the PK-96 for GPS Operation

Set up procedures for the PK-96 are described below for three Packet/GPS configurations: Stand Alone Tracking, APRS Hardware Single Port mode, and APRS Dual Port Mode. APRS software automatically sets the parameters for your TNC, except when the PK-96 is used as a Stand Alone Tracking Device (because APRS isn't connected).

### Stand Alone Tracking Device Set-up:

To set up the PK-96 for Stand Alone Tracking, follow these steps:

1. Connect your TNC to your computer and get it up and running following the directions in Chapter 2.
2. Type **MY <your call sign>-9**, then press ENTER. For example, if your call sign is WA7GCI you would enter **MY WA7GCI-9**, then press ENTER. The **-9** will cause others to see you as a car on the APRS map.
3. Program the UNPROTO command to: **UN APRS via RELAY**, then press ENTER. This programs your unproto path to APRS via RELAY.



4. Type **GLOctx 6**, then press ENTER. This causes the TNC to transmit its GPS location every 60 seconds. The seconds can range from 0 (disabled) to 255 in ten second increments.
5. Now you need to program the commands, GNMEA1 and/or GNMEA2, for the desired NMEA (GPS) sentences for the PK-96 to parse. Not all GPS receivers can send all NMEA sentences. So, the instructions you see below depend on the ability of your GPS receiver to send desired NMEA strings. In any case, the PK-96 can handle any NMEA strings your GPS or Loran receiver can produce.

To program GNMEA1, type **GNMEA1 \$GPGLL** and press ENTER. This command allows the PK-96 to parse the Position-Only NMEA string coming from the GPS receiver and place the string in the transmit buffer. The result of \$GPGLL is that you will be able receive from the GPS receiver Position-Only information and transmit it over the ham bands. (Any NMEA string your GPS receiver can produce can be entered in this command line.)

The neat thing about the PK-96 is that you can choose not one, but two NMEA strings to parse. You can, for instance, use Position-Only and Course/Speed. To program the second NMEA string for the PK-96, type **GNMEA2 \$GPVTG** and press ENTER. This sentence alone allows you to transmit course and speed. When coupled with the GNMEA1, your position, course, and speed will be transmitted together. (Again, you can use any NMEA string your GPS receiver can produce in this command line.)

*Note:* The NMEA sentence \$GPRMC is the recommended sentence for tracking moving objects as it contains time, latitude, longitude, course, and speed information-thus reducing the need for multiple NMEA sentences.

6. Now type **GPSAuto ON**, then press ENTER. This will cause the PK-96 to look for GPS data (coming from an attached GPS receiver) the next time it is powered on, and if it sees GPS data, the PK-96 will automatically switch to **GPSMode 1**.
7. Now you need to program the PK-96's terminal baud rate to match that of the GPS receiver, which is normally 4800 baud. To program the PK-96 terminal baud rate, type **TBAUD 4800**, then press ENTER.
8. Now turn your PK-96 off and disconnect your TNC from the computer. Take the PK-96 to your vehicle, connect the TNC to the GPS receiver and the radio, plug it in, power it up and you're in business. *Note:* Before powering up the PK-96, be sure the GPS receiver is powered up and outputting its NMEA sentences.

### Connecting the GPS receiver to the PK-96

Figure 4 below illustrates the pin assignments for connecting a GPS receiver to the PK-96. The same pin assignments can be used to connect to a Peet Bros. ULTIMETER II® weather station.

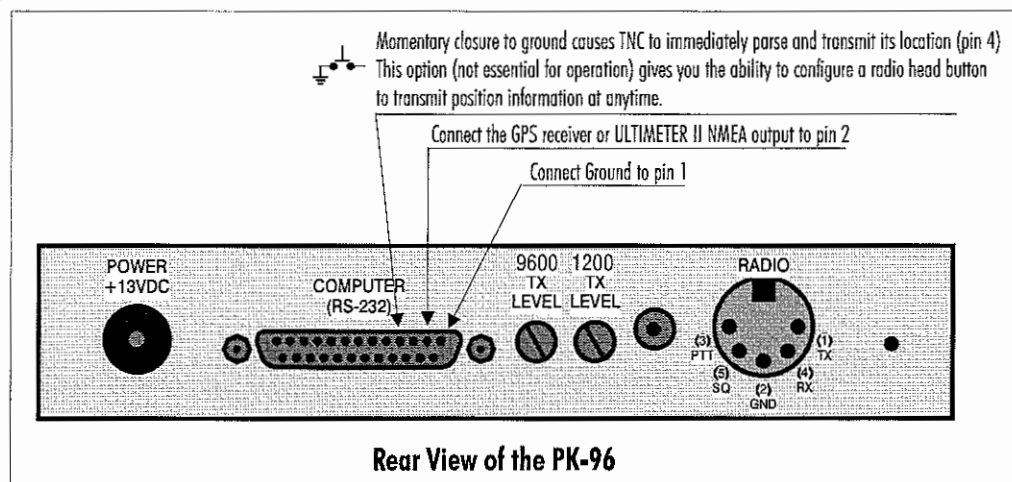

FIGURE 4: Pin assignments for connecting the PK-96 to a GPS receiver or to an Ultimeter II weather station

- When done using the PK-96 as a Stand Alone Tracking Device, connect your TNC to the computer again, verify that your terminal baud rate is at 4800 baud, 8 bits, no parity, one stop bit. A few seconds after powering up, the PK-96 will notice there is no GPS receiver connected and will display its sign-on message and command prompt.

### APRS Hardware Single Port Mode (HSP) Set-Up: Requires a registered version of APRS

APRS version 4.03 and higher includes a routine that controls the switching of the Single Port Mode between the TNC and any GPS receiver using the handshaking lines of the COM port. HSP allows you to operate APRS on a computer with limited COM ports, such as a laptop which usually has only one COM port, or your PC which uses one of the two COM ports dedicated to a mouse. This is the only configuration which uses the APRS adapter cable. You will need to have a registered copy of APRS in able to activate the GPS input. Registration information is contained in the APRS readme files.

*Follow these steps to connect the APRS Adapter Cable to your equipment:*

- Look at the APRS adapter cable. It looks like this:

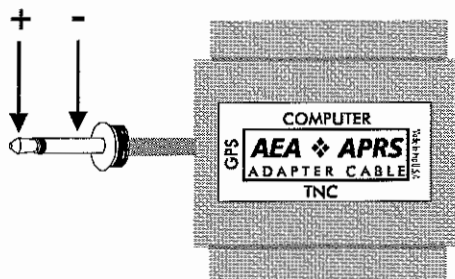

Notice the words on the outside of the rectangle; they say **TNC**, **Computer**, and **GPS**. This is how the Cable should be connected.

- Connect the APRS Adapter Cable to the serial port on the TNC. The male side of the Adapter Cable, labeled **TNC**, should be connected to the female serial port on the PK-96.
- Connect an RS-232 (not included) to a free COM port on your computer. Connect the other end of this cable to the RS-232 port marked "Computer" on the APRS Adapter Cable. (The *female side* of the Adapter Cable, labeled 'computer', should be connected to a cable going to the computer.)
- The cable that comes out the side of the APRS Adapter, labeled "GPS", connects to the NMEA-0183 port on your GPS receiver.

The cable is now correctly connected to your equipment.

*To set up the PK-96 for HSP operation, follow these steps:*

- Connect your TNC to your computer and to your GPS receiver using the Timewave APRS Adapter Cable following the steps noted previously. Get the computer running APRS software and the TNC running. Leave the GPS receiver off until you are ready to receive the NMEA string.
- Press **ALT-S** to bring up the setup menu.
- Now press **G** for GPS.
- Press **H** for HSP.
- Now press **ALT-S** to save.
- Enter **S** for SAVE.
- Now follow the prompt from APRS to validate your APRS registration and save the mode changes.
- Turn your GPS receiver on, and you are ready for APRS HSP operation.
- When finished using the PK-96 for APRS HSP operation, simply quit APRS. APRS may ask you for some information before quitting. Answer the questions and when done, your PK-96 will be ready for non-GPS activities.

## APRS Dual Port Mode Set-up:

To set up APRS for dual mode operation, follow these steps:

1. Connect your PK-96 to one of the COM ports on your computer. Get the TNC up and running following the directions in Chapter 2 of this manual.
2. Connect your GPS receiver to the other COM port on your computer. (You will need to build your own cable for this connection. Since there are many types of GPS receivers, all with different connections, we can't provide you with schematics on how to build this cable.)
3. Get the APRS software program running. APRS will ask you some questions, simply answer the questions and your TNC and APRS will be ready for dual port mode operation.

---

## Building your own APRS adapter cable

The APRS adapter cable works as follows:

The adapter allows for Hardware Single Port mode (HSP) operation, so you only need one computer COM port for both your GPS receiver and PK-96. The adapter normally has the TNC switched to the computer until APRS decides it's time to send its location report. When it's time to send position information, the computer running APRS asserts flow control to the TNC to prevent it from sending any more data. The flow control line is also used to switch the adapter to the GPS receiver. Once the GPS string is received, the computer running APRS releases flow control, switching back to the TNC.

A pre-made and tested cable can be purchased from Timewave or your favorite amateur radio dealer.

An APRS adapter cable can be made from the following components with the schematic shown on the next page.

| Item | Description            | Qty | Radio Shack Part # |
|------|------------------------|-----|--------------------|
| 1.   | PCB                    | 1   |                    |
| 2.   | 1K resistor            | 1   | 271-023            |
| 3.   | 10K resistor           | 2   | 271-034            |
| 4.   | IN4148 diode           | 2   | 276-1122           |
| 5.   | 2N3904 NPN transistor  | 2   | 276-2016           |
| 6.   | DB-25 male connector   | 1   |                    |
| 7.   | DB-25 female connector | 1   |                    |
| 8.   | DB-25 hood             | 1   |                    |
| 9.   | Screws for hood        | 1   |                    |
| 10.  | Saddle washers         | 1   |                    |
| 11.  | Hex nuts               | 1   |                    |
| 12.  | 6ft shielded cable     | 1   |                    |

## Connecting the APRS adapter cable

Once you've made your adapter cable, connect as described previously.

## Schematic Diagram for the APRS Adapter Cable

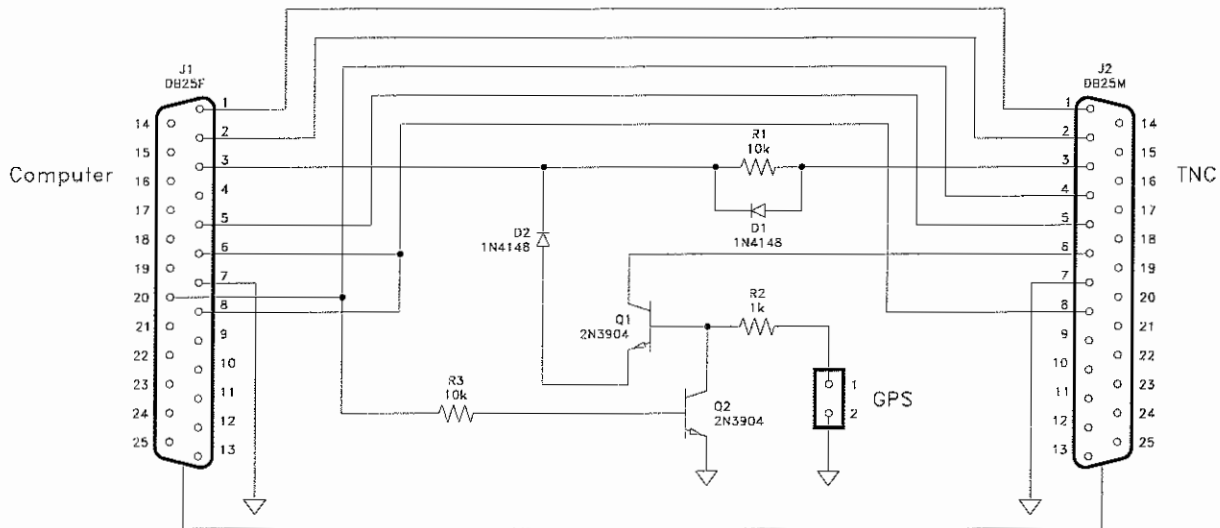

## PK-96/ULTIMETER II® Stand Alone Weather Station Set Up

Connect the ULTIMETER II to the PK-96 following the illustrations of Figure 3, Figure 4, and Figure 5. Once the connections are made, follow the directions below to configure the TNC.

1. Connect your TNC to your computer and get it running following the directions in Chapter 2.
2. Type **MY <your call sign>**, then press ENTER. For example, if your callsign is WA7GCI, you would enter MY WA7GCI, then press ENTER.
3. Type **UN APRS via RELAY**, then press ENTER. This programs your UNPROTO path to APRS via RELAY.
4. Type **GLOctx 60**, then press ENTER. This causes the PK-96 to transmit the weather information every 10 minutes. The seconds can range from 0 (disabled) to 255 in ten second increments.
5. Now you need to program your Btext with the day of the month, time, and your latitude and longitude. For example: if your exact location is 47°49.14'N, 122°15.72'W and the time and date is 9:11 AM June 23 1995, you would enter **BT @230911/4749.14N/12215.72W\_Lynnwood weather station**, then press ENTER.
6. Now type **Beacon E 60**, then press ENTER. This will cause your PK-96 to transmit its beacon text every five minutes. APRS must see the beacon text containing the position information and a weather symbol character before it will display your weather information.

7. Now you need to program the GNMEA1 sentence to match the output of the ULTIMETER II. Type **GNMEA1 #**, then press ENTER. This will cause the PK-96 to begin parsing the ULTIMETER II data starting with the # digit. ( *Note some ULTIMETER IIs start their string with a # digit and some start their strings with a \* digit. This value may have to be changed to a \* if it does not work upon installation.* )
8. Type **TBAUD 2400**, then press ENTER. This sets the PK-96 serial baud rate to match the output of the ULTIMETER II.
9. Now type **RESTART**, then press ENTER. This will cause the terminal baud rate to change to 2400 baud matching the ULTIMETER II. Change your terminal baud rate to 2400 baud to match that of the PK-96.
10. Now type **GPSMode 2**, then press ENTER. Now press ENTER again to enter the stand-alone weather station mode. Now disconnect the serial cable and connect the ULTIMETER II, and you are ready to transmit weather information in an APRS system.

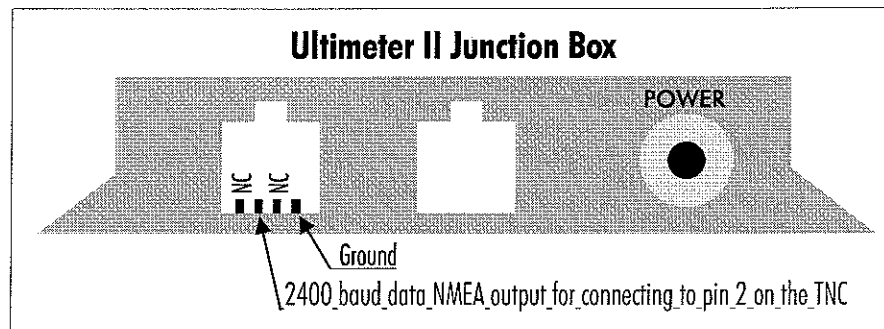

FIGURE 5: Ultimeter II junction box pin assignments

## Wireless Data/Location Tracking Applications

Timewave offers the Commercial GPS Adapter Cable for Wireless Data/Location Tracking Applications. This cable allows the GPS receiver and computer to share the TNC's serial interface. The PK-96 itself is designed to parse the incoming GPS information, that is, the TNC does the switching between the GPS receiver and the computer as illustrated in Figure 6. This allows the TNC to perform normal packet radio communications and also transmit position information in the background. Users who have a computer may transfer files and communicate with each other while also transceiving global positioning information. Users without computers can use the TNC as a Stand Alone Tracker to transmit position information to a base station that does have a computer keeping track of the location of many mobile vehicles.

The key to this set-up is having computer software that can handle both mapping and data transceiving tasks. Software of this kind is most often custom written for a specific business which is why we called the cable needed for wireless data/location tracking applications, the Commercial GPS Adapter Cable.

### Configuring the TNC

There is one hardware configuration possible when using the GPS Adapter Cable and that is for use with *wireless data/location tracking* applications. The GPS Adapter Cable makes it possible to transfer packet data while beaconing current location information in the background. If a computer is not going to be used, the Adapter Cable is not needed. If the Commercial GPS Adapter Cable is not used, the GPS receiver can be connected directly to the PK-96's serial port and the TNC should be configured for Stand Alone Tracking, discussed previously.

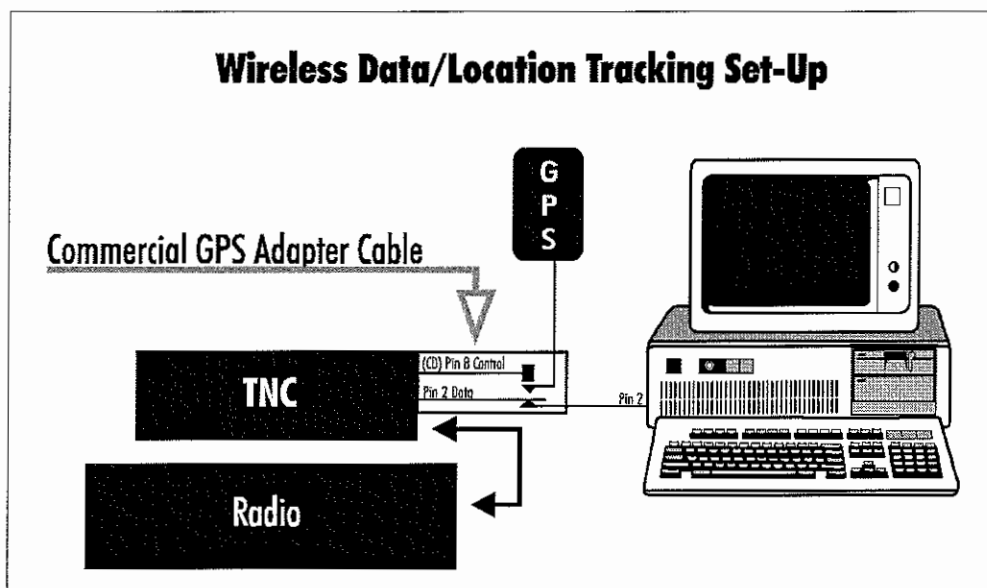

FIGURE 6: In this configuration, data and GPS information can be sent and received

#### *Wireless Data/Location Tracking setup:*

To set up the TNC for this application, follow these steps:

1. Connect the TNC to a computer and get it up and running, following the directions in the *Getting Started* section of the TNC's manual.
2. Type **MY <your callsign>**, then press ENTER. For example, if your call sign is WA7GCI, you would enter **MY WA7GCI**, then press ENTER.
3. Set the TBAUD to 4800, matching the GPS baud rate.
4. Type **GLOctx 6**, then press ENTER. This causes the TNC to transmit its GPS location every 60 seconds. The seconds can range from 0 (disabled) to 255 in ten second increments.
5. Now you need to program the commands, GNMEA1 and/or GNMEA2, for the desired NMEA (GPS) sentences the TNC will parse. Not all GPS receivers can send all NMEA sentences. So, the instructions you see below depend on the ability of your GPS receiver to send the desired NMEA strings. In any case, the Timewave TNC can handle any NMEA strings your GPS receiver can produce.

To program GNMEA1, type **GNMEA1 \$GPGLL** and press ENTER. This command allows the TNC to parse the Position-Only NMEA string coming from the GPS receiver and place the string in the transmit buffer. The result of \$GPGLL is that you will be able to receive from the GPS receiver Position-Only information and transmit it over the radio. (Any NMEA string your GPS receiver can produce can be entered in this command line.)

The nice thing about the Timewave TNCs is that you can choose not one, but two NMEA strings to parse. You can, for instance, use Position-Only and Course/Speed. To program the second NMEA string for the TNC, type **GNMEA2 \$GPVTG** and press ENTER. This sentence alone allows you to transmit course and speed. When coupled with the GNMEA1, your position, course, and speed will be transmitted together. (Again, you can use any NMEA string your GPS receiver can produce in this command line.)

**NOTE:**

*The NMEA sentence \$GPRMC is the recommended sentence for tracking moving objects as it contains time, latitude, longitude, course, and speed information.*

6. Now type **GPMode 3**, then press ENTER. This prepares the TNC to accept the NMEA strings from the GPS receiver through the GPS Adapter Cable.
7. Now turn your TNC off, disconnect your TNC from the computer and follow the GPS Adapter Cable connection instructions below.

### Connecting the GPS Adapter Cable to the TNC:

Follow these steps to connect the GPS Adapter Cable to your equipment:

1. Look at the GPS Adapter Cable. It looks like this:

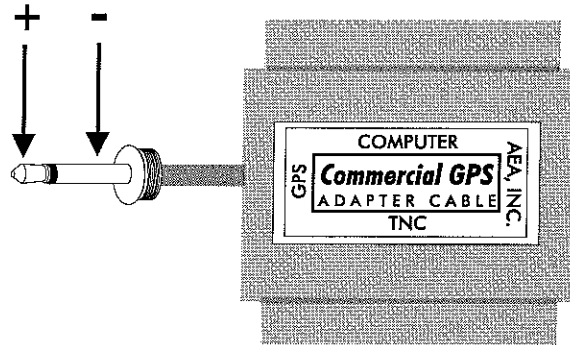

Notice the words on the outside of the rectangle; they say TNC, Computer, and GPS. This is how the Cable should be connected.

2. Connect the GPS Adapter Cable to the RS-232 port on the TNC. Use the end of the cable that reads "TNC."
3. Follow this step if you are using a computer with the TNC, if not, skip ahead to step four. Connect an RS-232 cable (not included) to a free COM port on your computer. Connect the end of this cable to the RS-232 port marked "Computer" on the GPS Adapter Cable.
4. Connect the cable that comes out the side of the GPS Cable Adapter, labeled "GPS," to the NMEA-0183 port on your GPS receiver. Note: the center, or tip, of the 1/8" plug is plus (+) and the other contact is ground (-).

The cable is now correctly connected to your equipment.





---

# 8. Troubleshooting

---

## Overview

This is a chapter we really didn't enjoy writing because it means that you're having trouble with your PK-96 and that you're not on the air. This chapter is by no means all-inclusive of everything that could cause problems, but it is a guide to help you solve the most common problems that occur.

Although the PK-96 is a complex piece of equipment, we've found that most troubleshooting problems are directly attributable to five simple sources:

- Insufficient power supply.
- Incorrect or improperly wired connections.
- Incorrect tuning procedure.
- Unfamiliarity with the commands.
- Software incongruities.

Because there are scores of different software and hardware configurations available to use with the PK-96, it's impossible to list all the solutions to the software/hardware-related problems you may encounter. Before you pull your hair out and call us in frustration, do what electronic technicians do: relax, do something else to clear your head, re-approach the problem, and try to think it through logically.

---

## A Troubleshooting Primer

The whole trick to troubleshooting is playing detective: your job is to determine the cause of the problem by eliminating what can—or can't—be the culprit. By using your head and a VOM (multimeter), you'll succeed 99% of the time.

The first step is to break down the main components in your system into subsystems. They are diagrammed in the following figure on the next page.

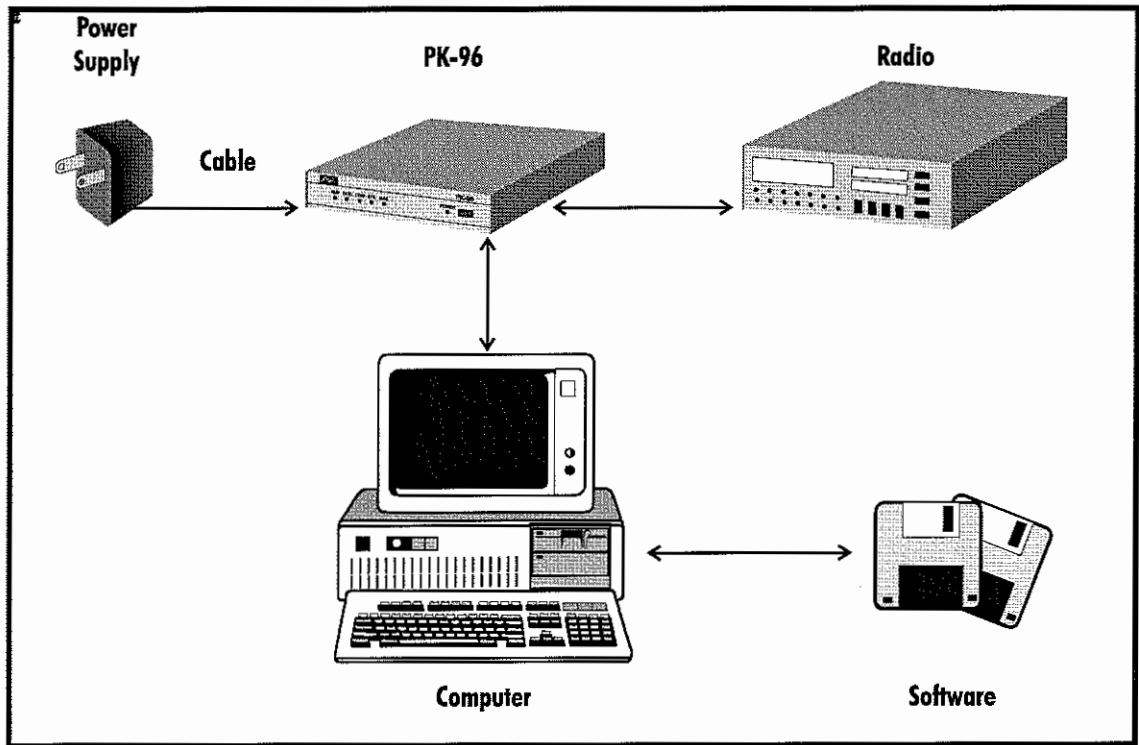

If you have an idea which subsystem might be the culprit, try substituting it with one you know is good. If your system works okay after the substitution is in place, you've found the culprit.

## The Power Supply

The PK-96 needs to be fed by a regulated power supply that can provide *at least 12 VDC @ 400mA under load*. Many amateurs connect all their station equipment to a single power supply and expect it to provide enough "juice" to make their transceiver(s) operate at full power, operate its accessories, and the PK-96. You may have purchased a "power cube" that's dedicated to your PK-96 and no other device. However, with both arrangements, if the power supply is insufficient to supply all the electrical needs of the device(s) connected to it, something has to suffer—which brings us to the PK-96.

You can find out if the PK-96 is getting enough juice by removing its chassis cover and measuring the voltage and current—while everything connected to its power supply is up and running at maximum current consumption—across and through its fuse found by the right-hand rear corner of the circuit board. Measure the voltage from one end of the fuse to the chassis (or another grounding point). For the current reading, turn the PK-96 off, lift one end of the fuse, connect your meter's probes in series between the fuse holder and lifted fuse end, then turn the unit back on. If the PK-96 is receiving less than adequate power and operating peculiarly, you'll need to connect a "beefier" power supply to power it.

## The Power Supply Cable

This is the second item you should check if your PK-96 doesn't power up; it's also the easiest subsystem component to troubleshoot. If you used the power cable that accompanied the PK-96 in its shipping carton, remember that the white stripe that runs alongside one edge of the wires is the positive (+) lead that goes from the (+) terminal on your power supply to the center conductor of the connector that plugs into the PK-96; the other conductor, of course, goes to the (-) of the power supply and "sleeve" (outer ring) of the PK-96's power connector. If you have these connected incorrectly or the supplied cable is polarized incorrectly, the PK-96 won't work at all.

If you're using a dedicated power cube for the PK-96, check its polarity—no manufacturer is perfect and on rare occasion the polarity of the wires might have been accidentally swapped. Again, use your VOM to see if this is the case.

If you find that the polarity is correct, tug gently at the wires both from the power supply end and connector end while measuring voltage or continuity. Tugging can reveal if there's an "open" in one or both of the conductors. If you find an open, either repair the damaged section, or replace the cable and/or power supply.

## The PK-96

Each PK-96 is tested at Timewave prior to shipping to make sure it operates properly. Most of the time troubles with the PK-96 are related to cabling, power supply, and pilot error, rather than the hardware itself.

## Cable from PK-96 to Computer

If you use a commercially produced, "straight through" (not a null modem) cable that has only pins 1-8 and 20 connected inside the DB-25 (PK-96) end and the proper pin-out arrangement in the other end, you shouldn't really have to suspect this component of the system. Perform a continuity check with your meter, flexing the cable at the base of connector while taking your reading to make sure that the internal connections are sound.

## Computer/Software

If you don't have your COM port and software set up properly for modem communication, you won't be able to "talk" to the PK-96. Since there are literally hundreds of computer configurations, it's up to you to make sure your system is set up correctly for serial port communications.

## Cable From PK-96 to Radio

Again, any problems here are attributable to a wiring error or connector failure. Make doubly sure you wired the cable correctly to the mike jack or accessory port in your radio; wiggle it at the connectors when performing a continuity check to see if a solder joint failed.

## Radio

If the PK-96 passes the loop-back test (*Chapter 3 - Computer/Radio Connections*) and you're absolutely sure that you wired the mike connector correctly, then you probably have your radio set improperly or it's not radiating a signal through the antenna. Make sure your radio system is fully operational and the antenna is properly tuned. (If you have a beam antenna, make sure it's pointed in the right direction.)

---

## If You Need to Call for Help

Call our Customer Service/Technical Support line at (651)222-4858 between 8:30 a.m. and 5:00 p.m. Central time, weekdays. Please have your PK-96's serial number and firmware version date available; the version date is listed on the first screen that comes up on the computer when you turn on the PK-96. We'll also need to know the specifics of any other equipment connected to the PK-96.

When you call, please have your PK-96 up and running, near the phone if possible. Our technician(s) will likely ask you to perform certain keyboard routines to aid in diagnosis of the problem. Try to have a voltmeter handy, too.

Timewave also provides technical assistance by email at [techsupport@timewave.com](mailto:techsupport@timewave.com). You may also fax us at (651) 222-4861.

Many of the products that are sent to us for repair are in perfect working order when we receive them. For these units, there is a standard checkout fee that you will be charged. Please perform whatever steps are ap-

plicable from the installation sections of this manual before you call or write—you'll only add to the cost of your phone bill if you don't! Please **don't** return your PK-96 to us without contacting us first: we'd like to help you troubleshoot the problem over the phone (or by mail) first, saving you both time and money.

If you're instructed by one of our technicians to return your unit to us, write the RMA number issued to you on the outside of the shipping carton—it will speed the processing of your unit. Inside the carton, enclose a note with your name, address, daytime phone number, RMA number, and a description of your PK-96's problem.

Our street address is:

Timewave Technology Inc.  
58 E. Plato Blvd.  
St. Paul, MN 55107 USA

We'll need your street address for UPS return—be sure to include it. UPS Surface (Brown Label) takes 7-10 days to reach us depending on your location, Blue takes 2-3 days. Red is an overnight service and is expensive. Send the PK-96 in a way that it can be traced if we can't verify receipt of shipment. We suggest UPS or insured postal shipment.

When you call for an RMA number, the technician can estimate the repair charges for you over the phone. This is another good reason to call us before sending your unit in for repair.

Typically, we repair equipment in five to ten working days after it arrives at Timewave *if we have all the facts*. If we must call you, it may take longer. Timewave isn't responsible for damage caused by lightning, nonprofessional alterations, "acts of God", shipping damage, poor storage/handling, etc. We'll make note of any shipping damage upon receipt.

Should your warranty card not be on file at Timewave, you'll need to send the proof of purchase date to receive warranty service. Typically, a copy of your invoice from an Timewave dealer will suffice. The warranty is for the original owner only and is not transferable.

---

## General Error Messages

An error message is displayed if the PK-96 doesn't understand what you typed or it needs more information. If you see this message, look up the command you want to enter to make sure you're entering it correctly.

|                       |                                                                                                                                        |
|-----------------------|----------------------------------------------------------------------------------------------------------------------------------------|
| ?what?                | Your PK-96 didn't understand your instructions—did you type the command correctly?                                                     |
| ?bad                  | You typed a command name correctly, but the remainder of the command line wasn't understood.                                           |
| ?call sign            | You typed a call sign that doesn't meet the PK-96's requirements.                                                                      |
| ?clock not set        | You typed the command DAYTIME, but you haven't yet set the clock.                                                                      |
| ?not enough           | You didn't type enough arguments for a command that needs several.                                                                     |
| ?range                | You typed a numeric argument too large or too small for that command.                                                                  |
| ?too many             | You typed too many arguments for the command to accept.                                                                                |
| ?too long             | You typed a command line that is too long. For example, if you type a BTEXT or CTEXT message that is too long you'll get this message. |
| ?need ALL/NONE/YES/NO | This message indicates you have forgotten the ALL, NONE, YES or NO arguments in the CFROM, DFROM, or MFROM commands.                   |

\*\*\* Transmit data remaining

You'll get this if the PK-96 is commanded back to receive (using the RCVE command) while it still has data in the transmit buffer waiting to be sent. To clear the transmit buffer, enter TC.

Serial port configuration will change on next RESTART

This message means you've changed TBAUD, word length AWLEN, or PARITY. When you type the RESTART command, the new baud rate will take effect.

---

## Packet Error Messages

In addition to the general error messages described in the previous section, the following messages may appear when entering packet related commands.

?need MYcall      Appears if you try to make a packet connection when you haven't entered your call sign in MYCALL.

?not while connected

You tried to change MYCALL or AX25L2V2 while in a connected state.

?not while disconnected

You tried to set CONPERM while disconnected.

LINK OUT OF ORDER, possible data loss

You're CONPERMed to another packet station but the link has failed.

?VIA

You typed more than one call sign for the CONNECT or UNPROTO commands without the VIA keyword.

?channel must be 0-9

You typed an invalid channel character after the CHSWITCH character.

?different connectees

You tried to connect to more than one station on the same channel.

?already connected (or attempting connection) to that station

You tried to connect to a station to which you're already connected.

too many packets outstanding

You typed enough data to fill the outgoing buffer in either the Converse or Transparent mode. You can't reenter Converse or Transparent mode until some of the packets have been sent.

WARNING: Beacon too often

You've set the BEACON interval timer to less than 90 (15 minutes) which is too often for busy channels.

WARNING: CHeck/FRack too small

You've set the CHECK timer for too short a time relative to the FRACK timer.

WARNING: RESptime/FRack too large

You've set the RESPTIME timer for too long a time relative to the FRACK timer.

WARNING: TXdelay too short

The TXDELAY timer has been set too short to send at least one complete flag before the start of a packet.

WARNING: AUdelay > TXdelay

The AUDELAY timer has been set equal to or greater than the TXDELAY timer.

Packet Link Status Messages

Link status messages show you the status of AX.25 connections in which your PK-96 is involved.

\*\*\* connect request: call1 [via call2]

Your PK-96 has received, but not accepted, a connect request from another station.

\*\*\* DISCONNECTED: call

Your PK-96 has switched to the disconnected state. This message may be preceded by a message explaining the reason for the disconnect.

\*\*\* Retry count exceeded

\*\*\* DISCONNECTED: call

Your PK-96 has been disconnected because of a retry failure, rather than a disconnect request, from one of the stations.

\*\*\* call busy

\*\*\* DISCONNECTED: call

Your connect request was rejected by a busy signal from another station.

FRMR sent: xx xx xxor FRMR rcvd: xx xx xx

You're connected but a protocol error has occurred. Your PK-96 is trying to re-synchronize frame numbers with the distant station. The string xx xx xx is replaced with the hex codes for the three bytes sent in the FRMR frame.

---

## MailDrop Error Messages

\*\*\* What? You've entered a command that the MailDrop doesn't recognize.

\*\*\* Need call sign.

You've tried to send a message but you didn't specify who you want to send it to.

\*\*\* Message not found.

You tried to list or read message(s) that the MailDrop couldn't find. This also appears if you try to list messages when there aren't any messages in your MailDrop.

\*\*\* No free memory.

You have tried to send a message, but the MailDrop doesn't have any memory left for more messages. You must kill messages now to make room.

\*\*\* Not your message.

A user will get this when trying to read a message number that is addressed to another station.

---

## PK-96 Status and Error Messages

From time to time, the PK-96 will generate messages informing you of its status. Error messages will also be generated if the PK-96 doesn't understand a command you've entered. This section describes the PK-96's messages and the circumstances which cause them.

Sign-on message:

```

AEA PK-96 Packet Controller
AX.25 Level 2 Version 2.0
Copyright (C) 1986-1995 by
Advanced Electronic Applications, Inc.
Release 16.AUG.95
Ver. 7.1

```

cmd:

The sign-on message appears when you turn on your PK-96, after system RESTART or RESET, and after the autobaud routine. The release date is updated whenever the firmware is changed to a later release. Please write this date on the first page of this manual in case it's needed for future reference.

PK-96 is using default values

This message appears the first time you turn on your PK-96 or every time you turn on the PK-96 if the battery jumper is missing. The message will also appear in response to the RESET command.

cmd:

This is the Command mode prompt. When this prompt appears, the PK-96 is waiting for you to issue a command. Anything you type after this prompt is interpreted as a command.

was

now

Whenever you change a parameter, both the previous value and the new value are displayed.

bbRAM scanned, checksum failed!

This message indicates there has been an error in the battery backed RAM. A weak lithium battery is most likely the cause for this.

ERROR: Subroutine, Bank, Addr

This message indicates a program error has occurred. Write down any information accompanying this message and call AEA's Technical Support department. If possible, print a DISP Z parameter listing.

ROM error, checksum \$xxxx

This message indicates there has been a failure in the PK-96. If this message appears, call AEA's Technical Support department.

---

## Out-of-the-Box Problems

The majority of these problems are directly attributable to insufficient power.

### Problem:

The PK-96 doesn't power up.

### Symptom:

No lights come on.

### Possible Causes:

- No power to PK-96.
- Blown power supply or PK-96 fuse.

### Try This:

First, check the power supply to see if it's on. Check the PK-96's power cord for an open connection or conductor.

Next, replace any blown fuses. Do not use overrated fuses or try to power up the device if it blows the replacement fuse.

If it's the PK-96 that is blowing fuses, call Timewave for assistance.

### **Problem:**

Power is sufficient but PK-96 won't initialize.

#### *Symptom:*

Start-up sequence of lights is erratic.

#### *Possible Causes:*

- PK-96 is underpowered.
- Too much AC ripple coming from the power supply.

#### *Try This:*

First, increase power to the PK-96 so it receives *at least* 12 VDC @ 400mA *under load*. Measure voltage from the PK-96's internal fuse holder to a ground trace or the chassis.

Next, connect a car battery to the PK-96. If it initializes correctly, then you'll know it is an AC ripple problem coming from your power supply.

---

## **Computer to PK-96 Problems**

The majority of these problems are directly attributable to incorrectly addressed serial (COM) ports, incorrect wiring, or poor solder joints. Make sure you use *only* pins 1-8 and 20 in the DB-25 connector. Also, perform a continuity check of the cable to make absolutely sure it's not an open circuit that is causing a problem.

### **Problem:**

Computer won't talk to the PK-96.

#### *Symptom:*

You don't receive the sign-on (autobaud) message when you power up the PK-96.

#### *Possible Causes:*

- An open line in the cable.
- Incorrectly wired cable.
- Incorrect COM port selected or IRQ conflict.
- Software communication parameters set incorrectly.

#### *Try This:*

First, continuity check the cable and repair if necessary.

Next, make sure that the cable is wired correctly.

If those two things don't remedy the problem, check to make sure you have the correct COM port selected. Change the IRQ of any shared device. (IRQ 5 generally works.)

If all else fails, reset software communications parameters as called out in *The Program, Chapter 2*.



---

## Radio to PK-96 Problems

The majority of these problems are directly attributable to incorrect wiring or poor solder joints. Perform a continuity check of the cable to make absolutely sure it's not an open circuit that is causing a problem.

### **Problem:**

Radio won't talk to the PK-96.

### *Symptom:*

You don't receive the sign-on (autobaud) message when you power up the PK-96.

### *Possible Causes:*

- Open line in cable.
- Incorrectly wired cable.

### *Try This:*

First, continuity check the cable and repair if necessary.

Next, make sure you have wired the cable correctly.

---

## MailDrop Problems

### **Problem:**

Unable to connect to other stations.

### *Symptom:*

PK-96 prints what? when you try to connect.

### *Possible Causes:*

- You're still logged onto your own MailDrop.

### *Try This:*

Exit your MailDrop by entering a B for B(ye).

### **Problem:**

MailDrop messages aren't date and time stamped.

### *Symptom:*

When scanning the message list you see "..." in the date and time fields.

### *Possible Causes:*

- The PK-96 has been "restarted" since the clock was last set, the power failed, the PK-96 was turned off, or RESTART was issued.

### *Try This:*

First, set the clock. If it continues to be a problem, check the stability of the PK-96's power supply—it must not drop below 12 VDC @ 400mA.

### **Problem:**

Other stations are unable to connect or link with your MailDrop.

### *Symptom:*

Stations are receiving a Busy response.

*Possible Causes:*

- The PK-96's memory buffer is full.
- **Users** command set to zero.
- You're currently logged into your MailDrop.

*Try This:*

First, empty the buffer either by turning the PK-96 off and then on again, or start serial communications between the PK-96 and your computer by pressing (CTRL-Q) and/or (CTRL-X).

Next, make sure that **USERS** is set to 1 or greater.

Lastly, make sure to exit your MailDrop by entering a B for B(ye).

---

## Packet Problems

**Problem:**

Unable to transmit.

*Symptom:*

You can copy stations on the frequency you're operating on, but when you attempt to connect, your radio doesn't transmit or nothing appears to happen.

*Possible Causes:*

- Threshold control mis-adjusted.
- **SQUELCH** is turned on and squelch (black) input in the radio cable isn't connected.
- Squelch input is connected.

*Try This:*

First, adjust threshold control so that DCD indicator is on when other stations are sending, and is off when the channel is free.

Next, make sure that **SQUELCH** is turned *OFF*. If your squelch input is connected, we do recommend in almost all cases that the Squelch input not be used.

**Problem:**

Unable to transmit.

*Symptom:*

You can copy stations on the frequency you're operating on, but when you attempt to connect, your radio will not transmit. You eventually see a message that says: `Retry Count Exceeded, Disconnected`.

*Possible Causes:*

- **XMITOK** is *OFF*.
- There's a fault in the radio cable wiring.

*Try This:*

First, turn **XMITOK** *ON*.

If that doesn't remedy the situation, recheck the radio cable wiring.

**Problem:**

Other stations are unable to connect to you.

*Symptom:*

Your station appears to ignore connect requests. Other stations don't acknowledge that your station is on-the-air.

*Possible Causes:*

- CFROM is set to ignore incoming connect requests.
- MYCALL isn't set or is incorrectly set.
- USERS set to zero.
- Possible unable to transmit problem.

*Try This:*

First, set CFROM to ALL.

Secondly, make sure that MYCALL is set to your call sign and that USERS is set to a value greater than zero.

If all else fails, see the "Unable to Transmit" section.

**Problem:**

You are unable to connect to others.

*Symptom:*

Your radio seems to transmit and receive normally, that is, it transmits for about ½ second every 5 to 10 seconds but you still can't connect.

*Possible Causes:*

- AFSK level not correctly adjusted.
- TXDELAY is too small for your radio; radio takes longer than the period of TXDELAY to key up on the air.

*Try This:*

First, adjust the AFSK level control following the procedures outlined in Chapter 3 for FM and SSB calibration. Proper adjustment of this control is critical to AFSK FM packet operations.

Second, try increasing the setting for TXDELAY. Experiment with this for optimum performance.

**Problem:**

Unable to monitor packets.

*Symptom:*

With obvious activity on the channel, you don't see any activity on your screen.

*Possible Causes:*

- HBAUD incorrectly set.

*Try This:*

Set HBAUD for the correct speed, either 1200 or 9600.

**Problem:**

Unable to monitor packets.

*Symptom:*

With obvious activity on the channel, you don't see any activity on your screen. WHYNOT reports - MONITOR.

*Possible Cause:*

- MONITOR turned off.

*Try This:*

Set MONITOR to a non-zero level. (The default is MONITOR 4.)

**Problem:**

Unable to monitor packets.

*Symptom:*

With obvious activity on the channel, you don't see any activity on your screen. WHYNOT reports - MCON.

*Possible Cause:*

- You're currently connected, or in the process of connecting, to another station and MCON is set such that received packets aren't being displayed.

*Try This:*

Usually, you won't want to monitor while you're connected, especially on busy channels. If you do, set MCON to a value greater than zero.

**Problem:**

Unable to monitor packets.

*Symptom:*

With obvious activity on the channel, you don't see any activity on your screen. WHYNOT reports - MPROTO.

*Possible Cause:*

- You're receiving packets which contain special network addressing.

*Try This:*

Either accept that you probably don't really want to see those packets, or turn MPROTO ON.

**Problem:**

Unable to monitor packets.

*Symptom:*

With obvious activity on the channel, you don't see any activity on your screen. WHYNOT reports - MBX.

*Possible Cause:*

- You have entered one or two calls into the special monitoring setting called MBX.

*Try This:*

Enter MBX % to clear this setting.

**Problem:**

Unable to monitor packets.

*Symptom:*

With obvious activity on the channel, you don't see any activity on your screen. WHYNOT reports -PASSALL.

*Possible Cause:*

- The packet you received has an error and wasn't displayed for this reason.

*Try This:*

Turn PASSALL ON to see the damaged packets if you want. If PASSALL is on, the MHEARD function is disabled.

**Problem:**

Unable to monitor packets.

*Symptom:*

With obvious activity on the channel, you don't see any activity on your screen. WHYNOT reports - frame to short.

*Possible Cause:*

- This was probably due to receiving a squelch burst or noise at the end of a valid transmission.

*Try This:*

No corrective action possible.

**Problem:**

Unable to monitor packets.

*Symptom:*

With obvious activity on the channel, you don't see any activity on your screen. WHYNOT reports - frame too long.

*Possible Cause:*

- This packet may have been sent by a station using a higher level networking protocol that allows packets larger than the AX.25 standard.

*Try This:*

No corrective action possible.

**Problem:**

MHEARD list doesn't display recently heard calls.

*Symptom:*

No calls listed, or all information is very old.

*Possible Causes:*

- PASSALL is ON.

*Try This:*

Turn PASSALL OFF.

**Problem:**

Monitored packets not correctly displayed.

*Symptom:*

You see monitored packets with garbage characters or obvious mistakes.

*Possible Causes:*

- PASSALL is ON.
- Mismatch between terminal or computer program serial settings, and PK-96's settings.

*Try This:*

First, make sure to turn PASSALL OFF.

---

## PK-96 Problems

**Problem:**

Unable to transmit.

*Symptom:*

XMT illuminates but radio doesn't switch to transmit.

*Possible Cause:*

- XMITOK is *OFF*.

*Try This:*

Disconnect radio cable from PK-96, then connect the red and brown wire on the radio cable plug together. While this short exists, your radio should transmit. If this is true, turn XMITOK *ON*.

**Problem:**

Sign-on message not correctly displayed.

*Possible Causes:*

- Mismatch between terminal or computer program serial settings and the PK-96 settings.

*Try This:*

Match settings between the PK-96 and computer program. For example if your computer is set for 8 data bits and no parity, set the PK-96 for AWLEN 8 and parity 0, then issue a *RESTART* to cause these changes to take effect in the PK-96.

**Problem:**

PK-96's buffer is filling with undesired information when your computer is off-line.

*Symptom:*

MAIL indicator is flashing after a period of absence from the PK-96.

*Possible Cause:*

- Text was received or monitored unintentionally.

*Try This:*

Check that the following commands are set as follows:

```
MONITOR 0
MCON 0
MDMON OFF
MDIGI OFF
MBX %
MBELL OFF
RFEC OFF
UBIT 13 ON
```

---

# Appendix A: Radio Connections

This appendix provides radio connection information from your Timewave data controller to approximately 400 different models of amateur transceivers.

Each radio listed references a connection figure and possibly a note on connections. Notes are below on this page. Connection figures appear following the table of radios. All pin type wiring connections are viewed from the wiring/solder side of the plug.

The wire colors used on the diagrams refer to the wires in the radio cables supplied with your Timewave data controller. The standard minimum configuration will allow operating of all HF modes with your radio set for SSB operation. When wiring information refers to FSK connections, these connections allow you to operate your radio in the RTTY or FSK mode, and usually results in a purer transmitted signal and usually allows using narrow filters that are not always available when the radio is set for SSB operation.

---

## Radio Connection Notes

- Note 1      Receive audio is not available on the microphone jack of all radios. If you make this connection and are unable to receive, use the speaker jack on the rear panel of the radio as a source of receive audio.
- Note 2      Your radio may not require a plug with three connections, i.e., tip, ring, and sleeve. We suggest you use the three-conductor "stereo" plug wired as shown, so that if you change radios to another model with this same connection scheme, your cable will be compatible without modification.
- Note 3      Older Icom transceivers which use the eight-pin microphone plug may not have receive audio connected to the microphone jack on pin 8. In this case, pin 8 is unused. We suggest you make the connection as diagrammed, even if your radio does not have receive audio available at pin 8. That way, if you change to a newer model Icom radio, the cable will be ready to use without modifications. If you make this connection and are unable to receive, use the speaker jack on the rear panel of the radio as a source of receive audio.
- Note 4      If you have difficulty in locating an eight-pin DIN plug for this connection, a five-pin DIN may be used in its place. A five-pin DIN has all the required pins for connections to ICOM HF rigs, because pins 6, 7, and 8 are not used. The numbering and arrangement of the remaining pins is unchanged.
- Note 5      In most Ten-Tec radios where an FSK input is provided, a pull-up resistor to a positive power source is required to produce proper function of the FSK keyer in the radio. Contact Ten-Tec for recommendations on how to add this resistor to the radio to which you are connecting.
- Note 6      This connection is appropriate for use at 9600 bps applications with your radio in DATA mode.
- Note 7      This connection is only valid with PCB-88, DSP-1232, DSP-2232, and PK-900 Radio Port 2.

## Radio Listings

| <b>ALINCO</b>      | <b>Figure</b> | <b>Note</b> |
|--------------------|---------------|-------------|
| ALD-24T            | 1             |             |
| ALR-22HT           | 1             |             |
| ALR-22T            | 1             |             |
| ALR-72T            | 1             |             |
| DJ-100             | 45            |             |
| DJ-120T            | 45            |             |
| DJ-160T            | 5             | 2           |
| DJ-162T            | 5             | 2           |
| DJ-180T            | 5             | 2           |
| DJ-200             | 45            |             |
| DJ-500             | 45            |             |
| DJ-560T            | 5             | 2           |
| DJ-580T            | 5             | 2           |
| DJ-F1T             | 5             | 2           |
| DJ-G1T             | 5             | 2           |
| DR-110T            | 1             | 1           |
| DR-112T            | 1             | 1           |
| DR-119T            | 2             | 1           |
| DR-1200T           | 2             | 1           |
| DR-130T            | 50            | 1           |
| DR-430T            | 1             | 1           |
| DR-510T            | 1             | 1           |
| DR-570T            | 1             | 1           |
| DR-590T            | 3             | 1           |
| DR-592T            | 3             | 1           |
| DR-599T            | 3             | 1           |
| DR-600T            | 3             | 1           |
| <b>AZDEN</b>       | <b>Figure</b> | <b>Note</b> |
| All W/ 12-PIN CONN | 46            |             |
| All W/8-PIN AMP    | 4             |             |
| PCS-2000           | 46            |             |
| PCS-5000           | 4             |             |
| PCS-6000           | 4             |             |
| PCS-7000           | 4             |             |
| <b>COLLINS</b>     | <b>Figure</b> | <b>Note</b> |
| KWM-380            | 6             |             |
| <b>DRAKE</b>       | <b>Figure</b> | <b>Note</b> |
| T4X                | 8             | 8           |
| T4XB               | 8             | 8           |
| T4XC               | 8             |             |
| TR-22              | 7             |             |
| TR-3               | 8             |             |
| TR-33              | 7             |             |
| TR-4               | 8             | 8           |
| TR-4C              | 8             | 8           |
| TR-4CW             | 8             |             |
| TR-6               | 8             | 8           |
| TR-7               | 7             |             |
| UV-3               | 7             |             |

| <b>ICOM</b>    | <b>Figure</b> | <b>Note</b> |
|----------------|---------------|-------------|
| IC-02 SERIES   | 5             | 2           |
| IC-03 SERIES   | 5             | 2           |
| IC-04 SERIES   | 5             | 2           |
| IC-12          | 5             | 2           |
| IC-120         | 12            | 3           |
| IC-1201        | 12            | 3           |
| IC-1271 SERIES | 12            | 3           |
| IC 1275 SERIES | 12            | 3           |
| IC-12G SERIES  | 5             | 2           |
| IC-2 SERIES    | 5             | 2           |
| IC-20          | 10            |             |
| IC-202         | 11            |             |
| IC-21          | 10            |             |
| IC-211         | 15            |             |
| IC-215         | 11            |             |
| IC-22          | 10            |             |
| IC-228 SERIES  | 12            | 3           |
| IC-229 SERIES  | 49            |             |
| IC-22A         | 10            |             |
| IC-22S         | 11            |             |
| IC-22U         | 12            | 3           |
| IC-230         | 10            |             |
| IC-2330 SERIES | 49            |             |
| IC-2400        | 12            | 3           |
| IC-2410 SERIES | 49            |             |
| IC-245         | 11            |             |
| IC-24AT        | 5             | 2           |
| IC-25 SERIES   | 12            | 3           |
| IC-2500        | 12            | 3           |
| IC-251         | 15            |             |
| IC-255         | 12            | 3           |
| IC-255         | 14            |             |
| IC-260         | 12            | 3           |
| IC-260         | 14            |             |
| IC-27 SERIES   | 12            | 3           |
| IC-271 SERIES  | 12            | 3           |
| IC-275 SERIES  | 12            | 3           |
| IC-28 SERIES   | 12            | 3           |
| IC-280         | 11            |             |
| IC-281         | 51            |             |
| IC-281         | 52            | 6           |
| IC-290 SERIES  | 12            | 3           |
| IC-2G SERIES   | 5             | 2           |
| IC-2GX         | 5             | 2           |
| IC-21 SERIES   | 5             | 2           |
| IC-2S SERIES   | 5             | 2           |
| IC-2SR SERIES  | 9             |             |
| IC-3SERIES     | 5             | 2           |
| IC-30          | 10            |             |
| IC-3200 SERIES | 12            | 3           |
| IC-3210 SERIES | 12            | 3           |
| IC-3220 SERIES | 12            | 3           |



|                |    |   |                   |               |             |
|----------------|----|---|-------------------|---------------|-------------|
| IC-3230 SERIES | 49 |   | IC-781            | 12            | 3           |
| IC-375 SERIES  | 12 | 3 | IC-781            | 17            | 4           |
| IC-37A         | 12 | 3 | IC-901            | 12            | 3           |
| IC-38A         | 12 | 3 | IC-970            | 16            | 4           |
| IC-3S SERIES   | 5  | 2 | IC-D1A            | 9             |             |
| IC-4 SERIES    | 5  | 2 | IC-P2 SERIES      | 5             | 2           |
| IC-402         | 11 |   | IC-P3 SERIES      | 5             | 2           |
| IC-449 SERIES  | 49 |   | IC-P4 SERIES      | 5             | 2           |
| IC-45 SERIES   | 12 | 3 | IC-U2 SERIES      | 5             | 2           |
| IC-451         | 15 |   | IC-U4 SERIES      | 5             | 2           |
| IC-47 SERIES   | 12 | 3 | IC-V21 SERIES     | 5             | 2           |
| IC-471 SERIES  | 12 | 3 | IC-W21 SERIES     | 5             | 2           |
| IC-475 SERIES  | 12 | 3 | IC-W2A            | 9             |             |
| IC-48 SERIES   | 12 | 3 | IC-X21 SERIES     | 5             | 2           |
| IC-490 SERIES  | 12 | 3 | IC-X2A            | 9             |             |
| IC-4G SERIES   | 5  | 2 | <b>KANTRONICS</b> | <b>Figure</b> | <b>Note</b> |
| IC-4S SERIES   | 5  | 2 | D4-10             | 43            |             |
| IC-4SR SERIES  | 9  |   | DVR 2-2           | 43            |             |
| IC-502         | 11 |   | <b>KENWOOD</b>    | <b>Figure</b> | <b>Note</b> |
| IC-505         | 12 | 3 | TH-205            | 31            |             |
| IC-551 SERIES  | 12 | 3 | TH-21             | 31            |             |
| IC-551 SERIES  | 15 |   | TH-215            | 31            |             |
| IC-560         | 12 | 3 | TH-22             | 31            |             |
| IC-575         | 12 |   | TH-225            | 31            |             |
| IC-575 SERIES  | 12 | 3 | TH-25             | 31            |             |
| IC-60          | 10 |   | TH-27             | 31            |             |
| IC-707         | 12 | 3 | TH-28             | 31            |             |
| IC-720         | 12 | 3 | TH-31             | 31            |             |
| IC-720A        | 15 |   | TH-315            | 31            |             |
| IC-725         | 12 | 3 | TH-41             | 31            |             |
| IC-725         | 16 | 4 | TH-42             | 31            |             |
| IC-726         | 12 | 3 | TH-45             | 31            |             |
| IC-726         | 16 | 4 | TH-47             | 31            |             |
| IC-728         | 12 | 3 | TH-48             | 31            |             |
| IC-728         | 16 |   | TH-75             | 31            |             |
| IC-729         | 12 | 3 | TH-77             | 31            |             |
| IC-729         | 16 |   | TH-78             | 31            |             |
| IC-730         | 12 | 3 | TM-201            | 3             |             |
| IC-735         | 12 | 3 | TM-221            | 3             |             |
| IC-735         | 16 | 4 | TM-231            | 3             |             |
| IC-737         | 12 | 3 | TM-231            | 53            | 7           |
| IC-737         | 16 |   | TM-241            | 3             |             |
| IC-740         | 12 | 3 | TM-241            | 53            | 7           |
| IC-740         | 13 |   | TM-2530           | 3             |             |
| IC-745         | 12 | 3 | TM-2550           | 3             |             |
| IC-745         | 13 |   | TM-2570           | 3             |             |
| IC-751         | 12 | 3 | TM-321            | 3             |             |
| IC-751         | 13 |   | TM-331            | 3             |             |
| IC-761         | 12 | 3 | TM-331            | 53            | 7           |
| IC-761         | 17 | 4 | TM-3530           | 3             |             |
| IC-765         | 12 | 3 | TM-401            | 3             |             |
| IC-765         | 17 | 4 | TM-421            | 3             |             |

|         |    |   |
|---------|----|---|
| TM-431  | 53 | 7 |
| TM-441  | 3  |   |
| TM-531  | 3  |   |
| TM-531  | 53 | 7 |
| TM-541  | 3  |   |
| TM-621  | 3  |   |
| TM-631  | 3  |   |
| TM-631  | 53 | 7 |
| TM-641  | 47 |   |
| TM-701  | 53 | 7 |
| TM-721  | 3  |   |
| TM-731  | 3  |   |
| TM-731  | 53 | 7 |
| TM-732  | 47 |   |
| TM-741  | 47 |   |
| TM-742  | 47 |   |
| TM-941  | 47 |   |
| TM-942  | 47 |   |
| TR-2200 | 11 |   |
| TR-2300 | 11 |   |
| TR-2400 | 33 |   |
| TR-2500 | 32 |   |
| TR-2600 | 31 |   |
| TR-3200 | 3  |   |
| TR-50   | 3  |   |
| TR-7400 | 11 |   |
| TR-7500 | 32 |   |
| TR-751  | 3  |   |
| TR-7600 | 37 |   |
| TR-7730 | 36 |   |
| TR-7750 | 36 |   |
| TR-7800 | 36 |   |
| TR-7850 | 36 |   |
| TR-7930 | 36 |   |
| TR-7950 | 36 |   |
| TR-851  | 3  |   |
| TR-9000 | 36 |   |
| TR-9130 | 36 |   |
| TR-9500 | 36 |   |
| TS-120  | 11 |   |
| TS-130  | 11 |   |
| TS-140  | 3  |   |
| TS-140  | 35 |   |
| TS-430  | 3  |   |
| TS-440  | 3  |   |
| TS-440  | 34 |   |
| TS-450  | 3  |   |
| TS-450  | 38 |   |
| TS-450  | 54 | 9 |
| TS-490  | 11 |   |
| TS-50   | 39 |   |
| TS-50   | 53 | 7 |
| TS-520  | 11 |   |

|                    |               |             |
|--------------------|---------------|-------------|
| TS-530             | 11            |             |
| TS-60              | 39            |             |
| TS-60              | 53            | 7           |
| TS-670             | 3             |             |
| TS-680             | 3             |             |
| TS-680             | 35            |             |
| TS-690             | 3             |             |
| TS-690             | 35            |             |
| TS-700             | 11            |             |
| TS-701             | 3             |             |
| TS-711             | 3             |             |
| TS-711             | 34            |             |
| TS-780             | 3             |             |
| TS-790             | 3             |             |
| TS-790             | 35            |             |
| TS-811             | 3             |             |
| TS-811             | 34            |             |
| TS-820             | 11            |             |
| TS-830             | 11            |             |
| TS-850             | 3             |             |
| TS-850             | 39            |             |
| TS-850             | 55            | 9           |
| TS-900             | 11            |             |
| TS-930             | 3             |             |
| TS-940             | 3             |             |
| TS-940             | 34            |             |
| TS-940             | 56            | 9           |
| TS-950             | 3             |             |
| TS-950             | 39            |             |
| TW-4000            | 3             |             |
| TW-4100            | 3             |             |
| <b>RADIO SHACK</b> | <b>Figure</b> | <b>Note</b> |
| HTX-100            | 2             |             |
| HTX-202            | 5             | 2           |
| HTX-404            | 5             | 2           |
| <b>RANGER</b>      | <b>Figure</b> | <b>Note</b> |
| AR-2500            | 44            |             |
| <b>STANDARD</b>    | <b>Figure</b> | <b>Note</b> |
| C-128              | 5             | 2           |
| C-168              | 5             | 2           |
| C-188              | 5             | 2           |
| C-228              | 5             | 2           |
| C-288              | 5             | 2           |
| C-468              | 5             | 2           |
| C-468              | 5             | 2           |
| C-488              | 5             | 2           |
| C-500              | 5             | 2           |
| C-528              | 5             | 2           |
| C-558              | 5             | 2           |
| C-628              | 5             | 2           |
| <b>TEN-TEC</b>     | <b>Figure</b> | <b>Note</b> |
| All W/ 4-PIN AMP   | 41            | 5           |
| ALL W/.25" PLUG    | 42            |             |

|                |               |             |  |
|----------------|---------------|-------------|--|
| ARGONAUT II    | 41            |             |  |
| DELTA II       | 41            |             |  |
| PARAGON        | 41            | 5           |  |
| <b>UNIDEN</b>  | <b>Figure</b> | <b>Note</b> |  |
| HR-2510        | 40            |             |  |
| HR-2600        | 40            |             |  |
| <b>WILSON</b>  | <b>Figure</b> | <b>Note</b> |  |
| MARK II        | 29            |             |  |
| MARK IV        | 29            |             |  |
| WE-800         | 29            |             |  |
| <b>YAESU</b>   | <b>Figure</b> | <b>Note</b> |  |
| CPU-2500       | 28            |             |  |
| FT-1           | 18            |             |  |
| FT-1           | 20            |             |  |
| FT-1000 SERIES | 18            |             |  |
| FT-1000 SERIES | 20            |             |  |
| FT-101         | 22            |             |  |
| FT-101B        | 22            |             |  |
| FT-101E        | 22            |             |  |
| FT-101EE       | 22            |             |  |
| FT-101EX       | 22            |             |  |
| FT-101ZD       | 22            |             |  |
| FT-102         | 18            |             |  |
| FT-103R        | 5             | 2           |  |
| FT-107         | 18            |             |  |
| FT-109         | 5             | 2           |  |
| FT-11          | 5             | 2           |  |
| FT-200         | 23            |             |  |
| FT-203         | 5             | 2           |  |
| FT-207         | 29            |             |  |
| FT-208         | 29            |             |  |
| FT-209         | 5             | 2           |  |
| FT-211         | 18            |             |  |
| FT-211RH       | 27            |             |  |
| FT-212RH       | 27            |             |  |
| FT-2200        | 18            |             |  |
| FT-221         | 22            |             |  |
| FT-227         | 22            |             |  |
| FT-23          | 5             | 2           |  |
| FT-230         | 26            |             |  |
| FT-231R        | 27            |             |  |
| FT-2400        | 30            |             |  |
| FT-26          | 5             | 2           |  |
| FT-270         | 26            |             |  |
| FT-2700        | 27            |             |  |
| FT-290 MK I    | 26            |             |  |
| FT-290 MK II   | 18            |             |  |
| FT-290 MK II   | 27            |             |  |
| FT-2F          | 22            |             |  |
| FT-311RM       | 27            |             |  |
| FT-33          | 5             | 2           |  |
| FT-41          | 5             | 2           |  |
| FT-411         | 5             | 2           |  |
| FT-415         | 5             | 2           |  |
| FT-416         | 5             | 2           |  |
| FT-470         | 5             | 2           |  |
| FT-4700        | 27            |             |  |
| FT-480         | 18            |             |  |
| FT-5100        | 18            |             |  |
| FT-5100        | 48            |             |  |
| FT-5200        | 27            |             |  |
| FT-530         | 5             | 2           |  |
| FT-6200        | 27            |             |  |
| FT-650         | 18            |             |  |
| FT-690 MK I    | 26            |             |  |
| FT-690 MK II   | 18            |             |  |
| FT-690 MK II   | 27            |             |  |
| FT-703         | 5             | 2           |  |
| FT-707         | 18            |             |  |
| FT-708         | 29            |             |  |
| FT-709         | 5             | 2           |  |
| FT-711RH       | 27            |             |  |
| FT-712         | 18            |             |  |
| FT-7200        | 18            |             |  |
| FT-726         | 18            |             |  |
| FT-727         | 5             | 2           |  |
| FT-73          | 5             | 2           |  |
| FT-730         | 26            |             |  |
| FT-736         | 18            |             |  |
| FT-736         | 25            |             |  |
| FT-7400        | 30            |             |  |
| FT-747         | 18            |             |  |
| FT-757         | 18            |             |  |
| FT-757         | 19            |             |  |
| FT-76          | 5             | 2           |  |
| FT-767         | 18            |             |  |
| FT-767         | 19            |             |  |
| FT-767         | 24            |             |  |
| FT-77          | 18            |             |  |
| FT-790 MK I    | 26            |             |  |
| FT-790 MK II   | 18            |             |  |
| FT-790 MK II   | 27            |             |  |
| FT-811         | 5             | 2           |  |
| FT-815         | 5             | 2           |  |
| FT-816         | 5             | 2           |  |
| FT-840 SERIES  | 18            |             |  |
| FT-890         | 18            |             |  |
| FT-901         | 22            |             |  |
| FT-902         | 22            |             |  |
| FT-911         | 5             | 2           |  |
| FT-912         | 18            |             |  |
| FT-980         | 18            |             |  |
| FT-990 SERIES  | 18            |             |  |
| FT-990 SERIES  | 21            |             |  |

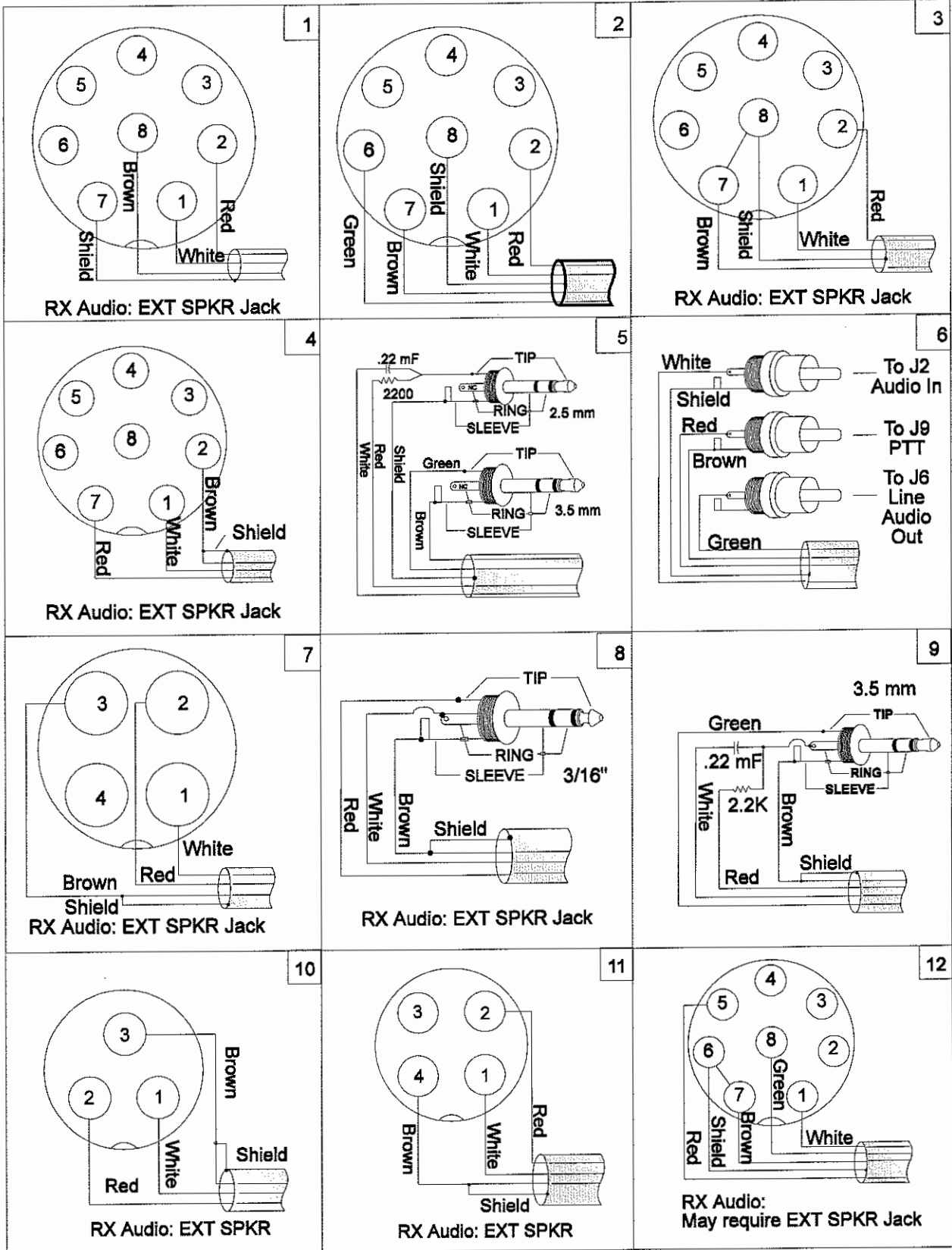

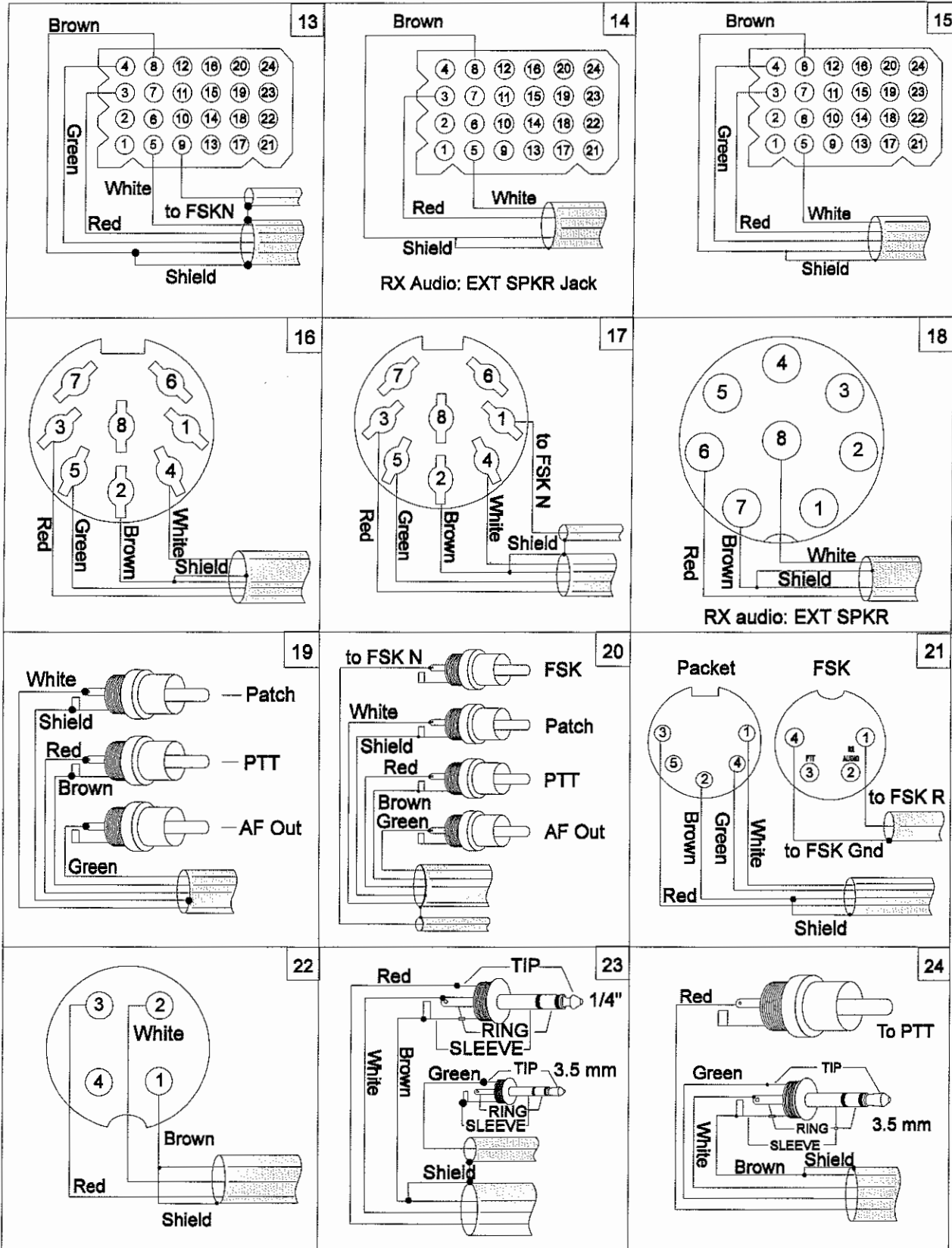

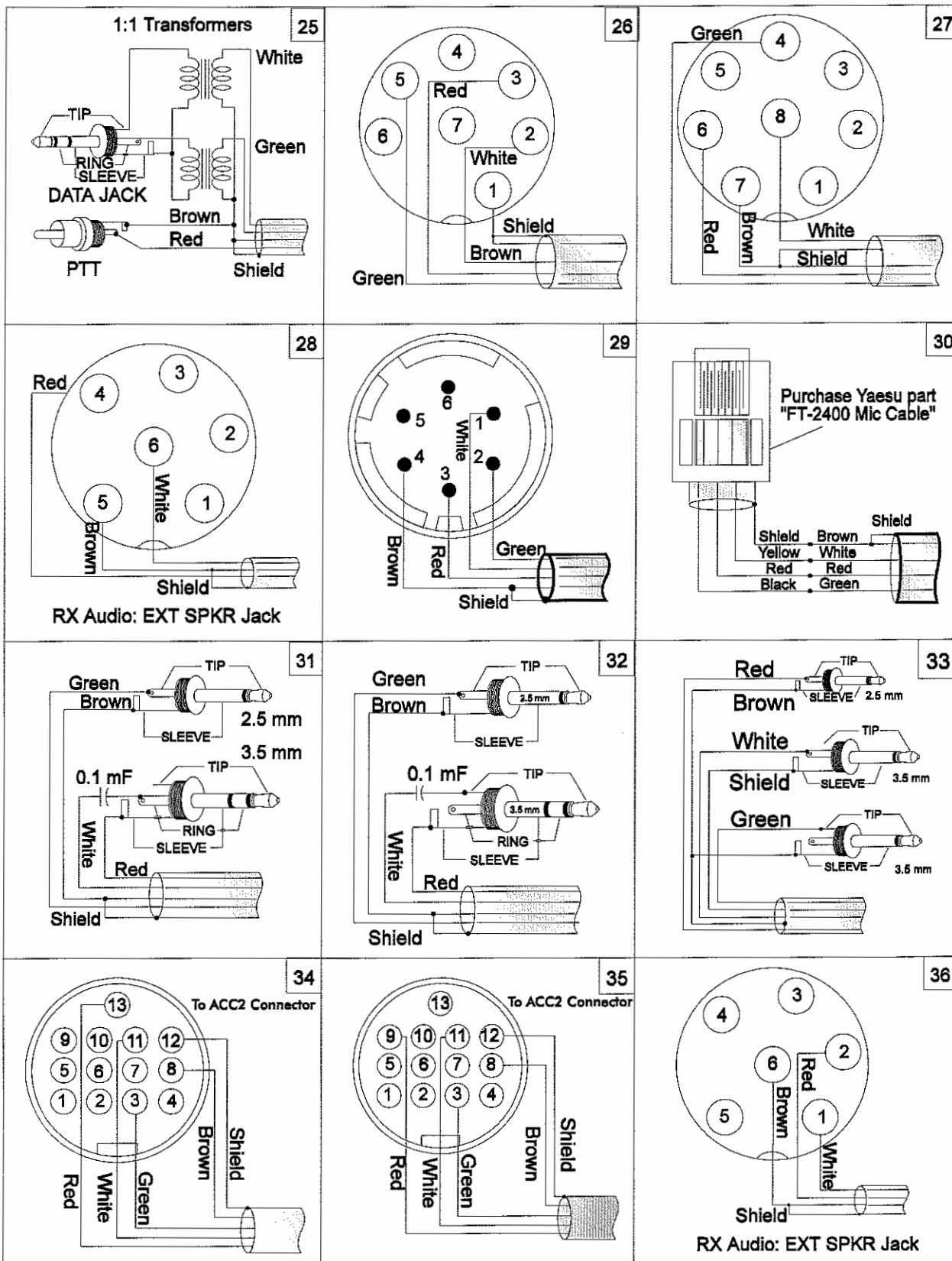

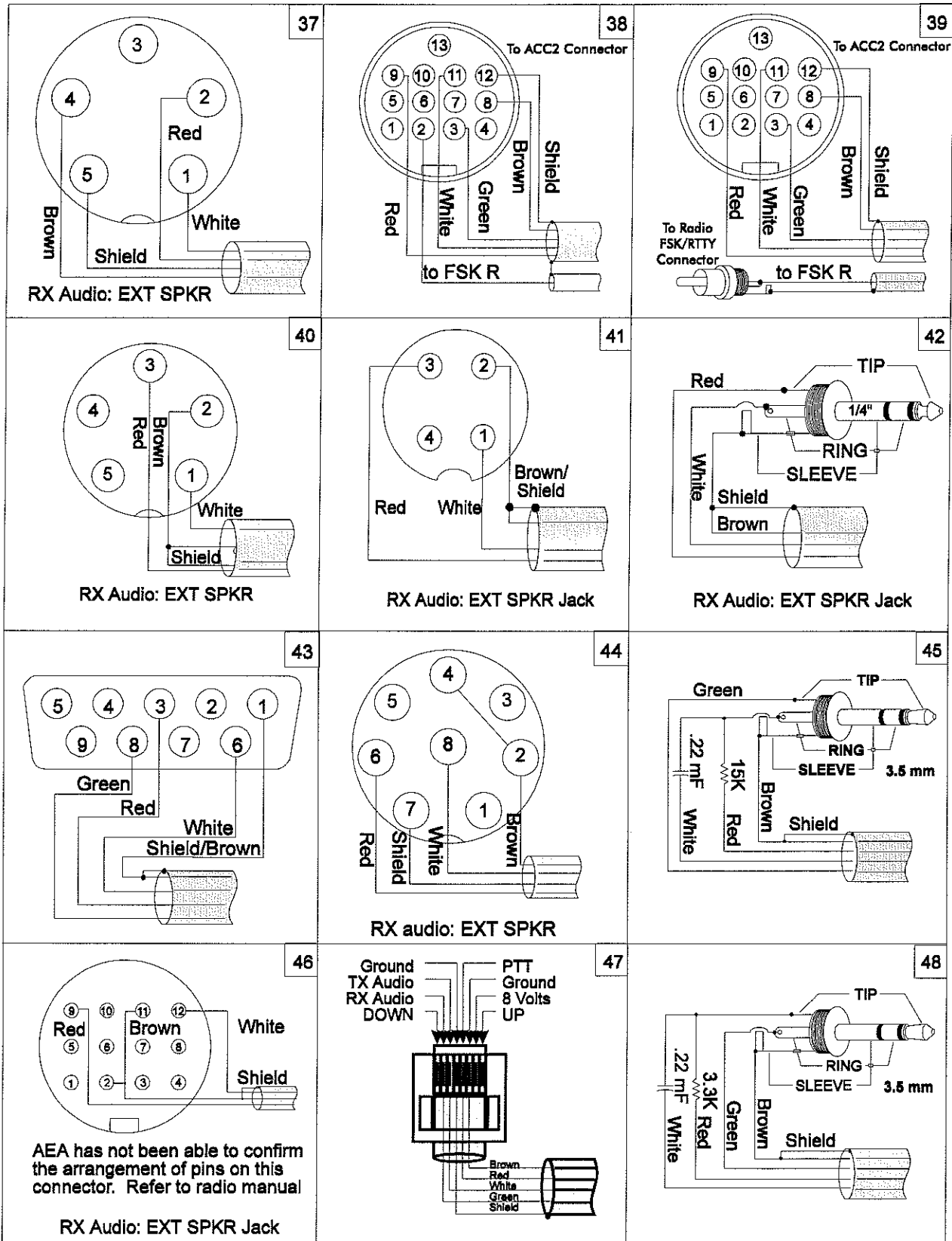

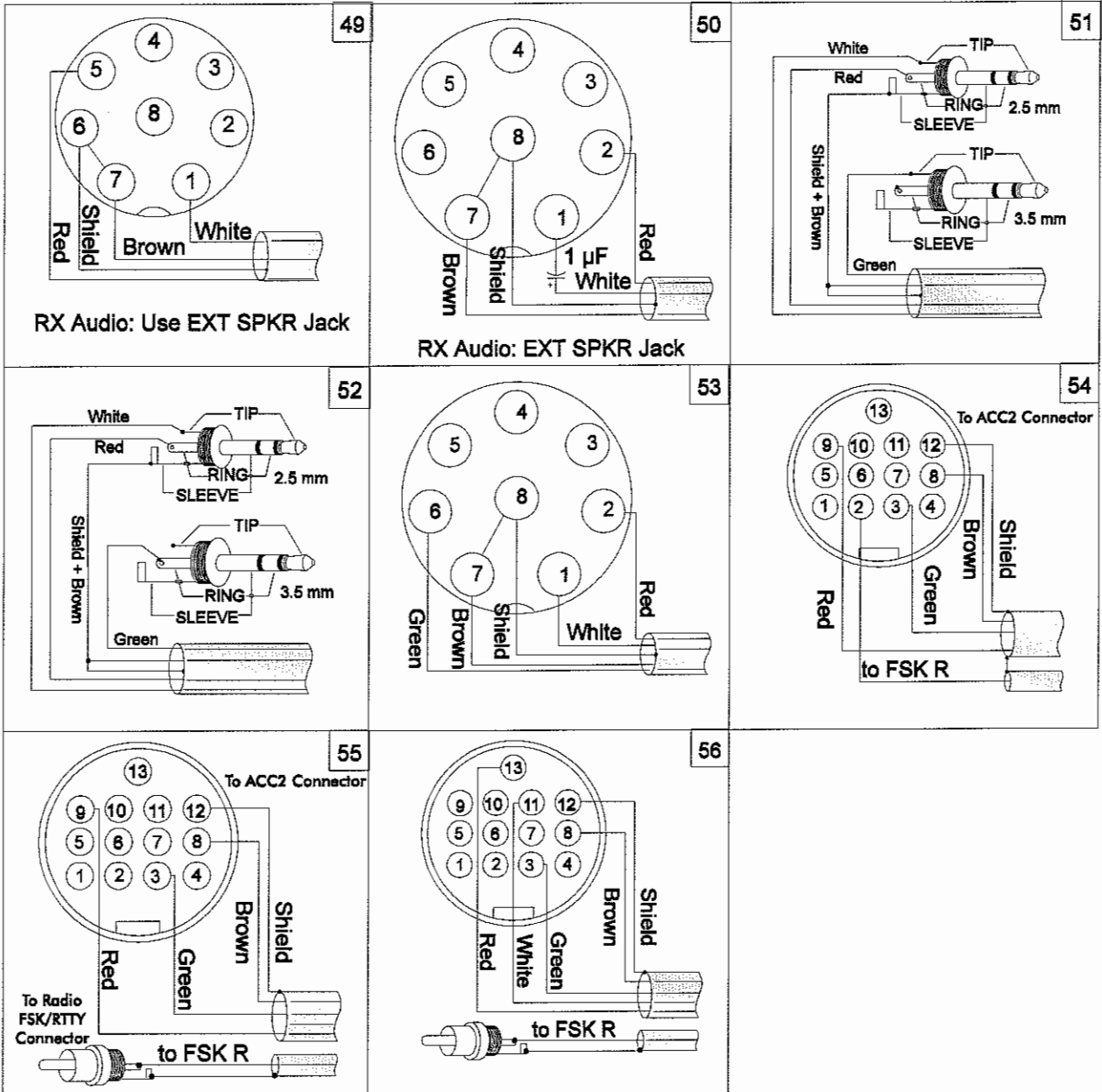



# Appendix B: Parts List, Schematics, and Pictorial Diagram

## Capacitors

|                                                      |      |               |  |
|------------------------------------------------------|------|---------------|--|
| C49                                                  | MY   | .0056 $\mu$ F |  |
| C42,C43,C44                                          | MY   | .01 $\mu$ F   |  |
| C45,C48                                              | MY   | .002 $\mu$ F  |  |
| C46,C50                                              | MY   | .022 $\mu$ F  |  |
| C26                                                  | CER  | 33 pF         |  |
| C25,C27                                              | CER  | 330 pF        |  |
| C47                                                  | CER  | 470 pF        |  |
| C51                                                  | CER  | 560 pF        |  |
| C28                                                  | CER  | 100 pF        |  |
| C15-C19,C38-C40                                      | CER  | .001 $\mu$ F  |  |
| C24                                                  | CER  | .01 $\mu$ F   |  |
| C10,C11,C32,C33                                      | CER  | 22 pF         |  |
| C22                                                  | CER  | .47 $\mu$ F   |  |
| C5                                                   | CER  | .001 $\mu$ F  |  |
| C1-3,C6,C7,C9,<br>C12-14,C20,C21,<br>C23,C34,C36,C53 | MONO | .1 $\mu$ F    |  |
| C35                                                  | MONO | .22 $\mu$ F   |  |
| C30                                                  | EL   | 47 $\mu$ F    |  |
| C4,C8,C31,C37, C41                                   | TA   | 10 $\mu$ F    |  |
| C52                                                  | TA   | 1 $\mu$ F     |  |

## Resistors (all are 1/4 Watt)

|                                    |    |                |
|------------------------------------|----|----------------|
| R5-7,R42                           | 5% | 100 $\Omega$   |
| R2,R12,R13,R15,<br>R20,R30,R31,R51 | 5% | 1K $\Omega$    |
| R7,R4,R41, R35                     | 5% | 10K $\Omega$   |
| R34                                | 5% | 12K $\Omega$   |
| R79                                | 5% | 2K $\Omega$    |
| R11                                | 5% | 220K $\Omega$  |
| R10                                | 5% | 27K $\Omega$   |
| R36,R50                            | 5% | 470 $\Omega$   |
| R14                                | 5% | 4.7K $\Omega$  |
| R16-18,R35                         | 5% | 47K $\Omega$   |
| R8                                 | 5% | 470K $\Omega$  |
| R39,R40                            | 5% | 510 $\Omega$   |
| R9                                 | 5% | 56K $\Omega$   |
| R1                                 | 5% | 68K $\Omega$   |
| R52-54                             | 1% | 3.01K $\Omega$ |
| R44,R45                            | 1% | 3.09K $\Omega$ |
| R32                                | 1% | 39.2K $\Omega$ |

|         |    |                |
|---------|----|----------------|
| R33     | 1% | 47.5K $\Omega$ |
| R47     | 1% | 4.99K $\Omega$ |
| R48,R49 | 1% | 5.36K $\Omega$ |
| R46     | 1% | 5.62K $\Omega$ |

## Potentiometers

|     |        |              |
|-----|--------|--------------|
| R43 | (trim) | 1K $\Omega$  |
| R38 | (trim) | 10K $\Omega$ |

## Networks

|     |       |               |
|-----|-------|---------------|
| RN1 | (SIP) | 330 $\Omega$  |
| RN2 | (SIP) | 4.7K $\Omega$ |
| RN3 | (DIP) | 100K $\Omega$ |
| RN4 | (DIP) | 47K $\Omega$  |

## Diodes

|       |        |        |
|-------|--------|--------|
| D2-14 | signal | 1N4448 |
| D11   | power  | 1N4004 |
| DS1   | LED    | Green  |
| DS2-6 | LED    | Red    |

## Transistors

|      |      |        |
|------|------|--------|
| Q1-3 | PFET | 2N7000 |
|------|------|--------|

## Integrated Circuits

|                   |          |          |
|-------------------|----------|----------|
| U14               | 7805     |          |
| U19               | LM358    |          |
| U20               | MC34074P |          |
| U21               | LM393    |          |
| U17,U27           | 74HC02   |          |
| U15               | 74HCT04  |          |
| U7,U16            | 74HC14   |          |
| U4                | 74HCT32  |          |
| U25,U26           | 74HCT74  |          |
| U22               | 74HCT86  |          |
| U5                | 74HC259  |          |
| U8                | 74HC374  |          |
| U12               | 74HC393  |          |
| U9                | 27C256   |          |
| U3                | 62256-12 |          |
| U1                | 64180A   |          |
| U2                | 27C512   |          |
| U3 (if 100 model) |          | HM628128 |
| U10               | Z8530    |          |
| U18               | TCM3105  |          |
| U13               | DS1232   |          |
| U23,U24           | MC14006  |          |

U11 CD4053  
U6 MC1488

### *Hardware*

U6 DIP socket 14 PIN  
U9 DIP socket 28 PIN  
U2,U3 DIP socket 32 PIN  
JP1 HDR STR .10 2 POS  
JP3 HDR STR .10 3 POS  
J2 HDR R/A 'D' F/M DB25  
J1 JACK PWR 2.1mm  
J3 JACK PHONO 3.5mm  
J4 CONN R/A DIN 5 PIN  
SW1 KNOB SW GRY .4 x .2  
F1 FUSE CLIP PCB  
B1 BATTERY—Lithium  
F1 FUSE 1 AMP- AGC  
JP1,JP3 SHORT PLUG .10

### *Switches*

SW1 Switch P-P — 2P2T  
SW2 Switch

### *Crystals*

Y1 12.288 MHz crystal  
Y3 4.433619 MHz crystal  
Y2 4.9152 MHz crystal

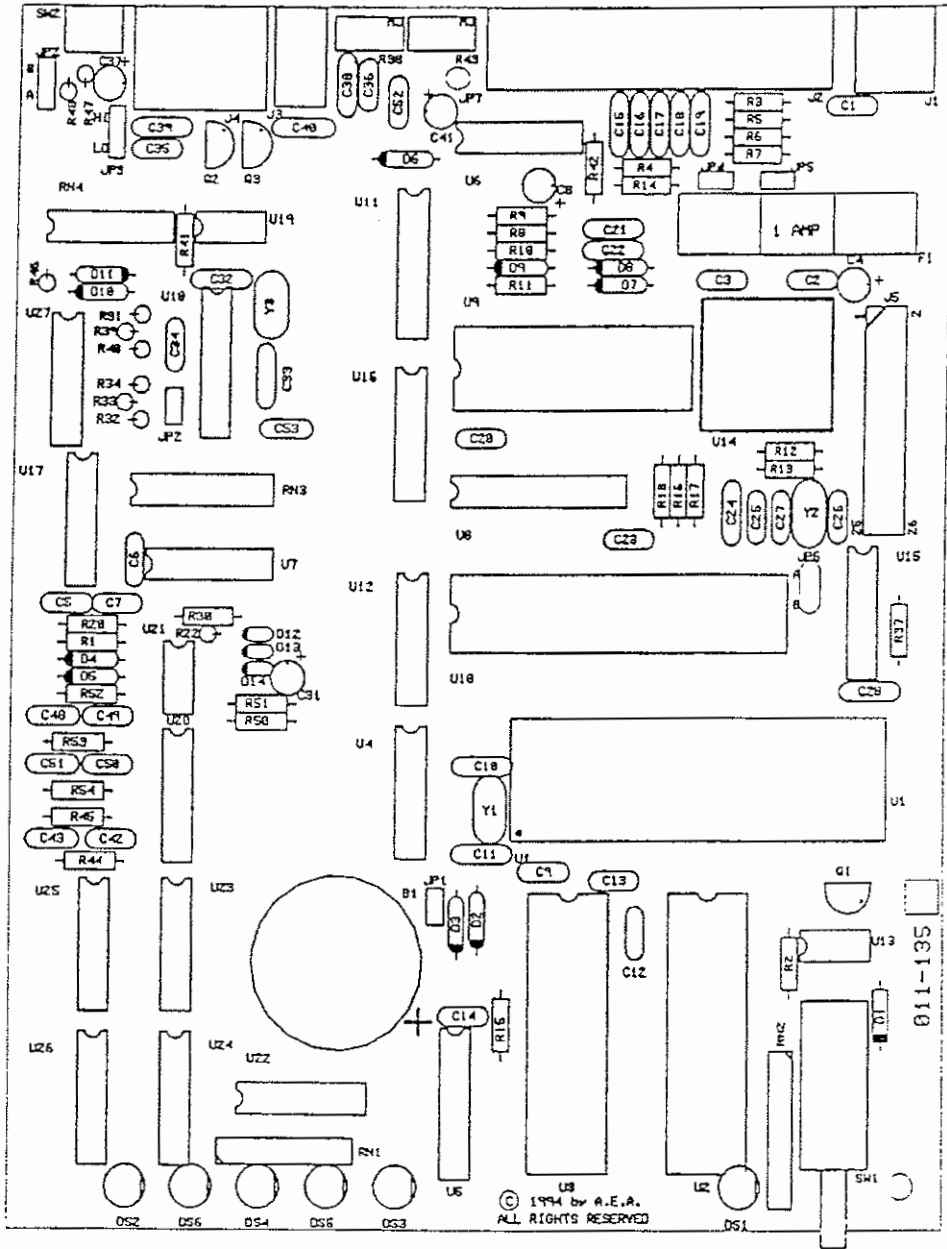

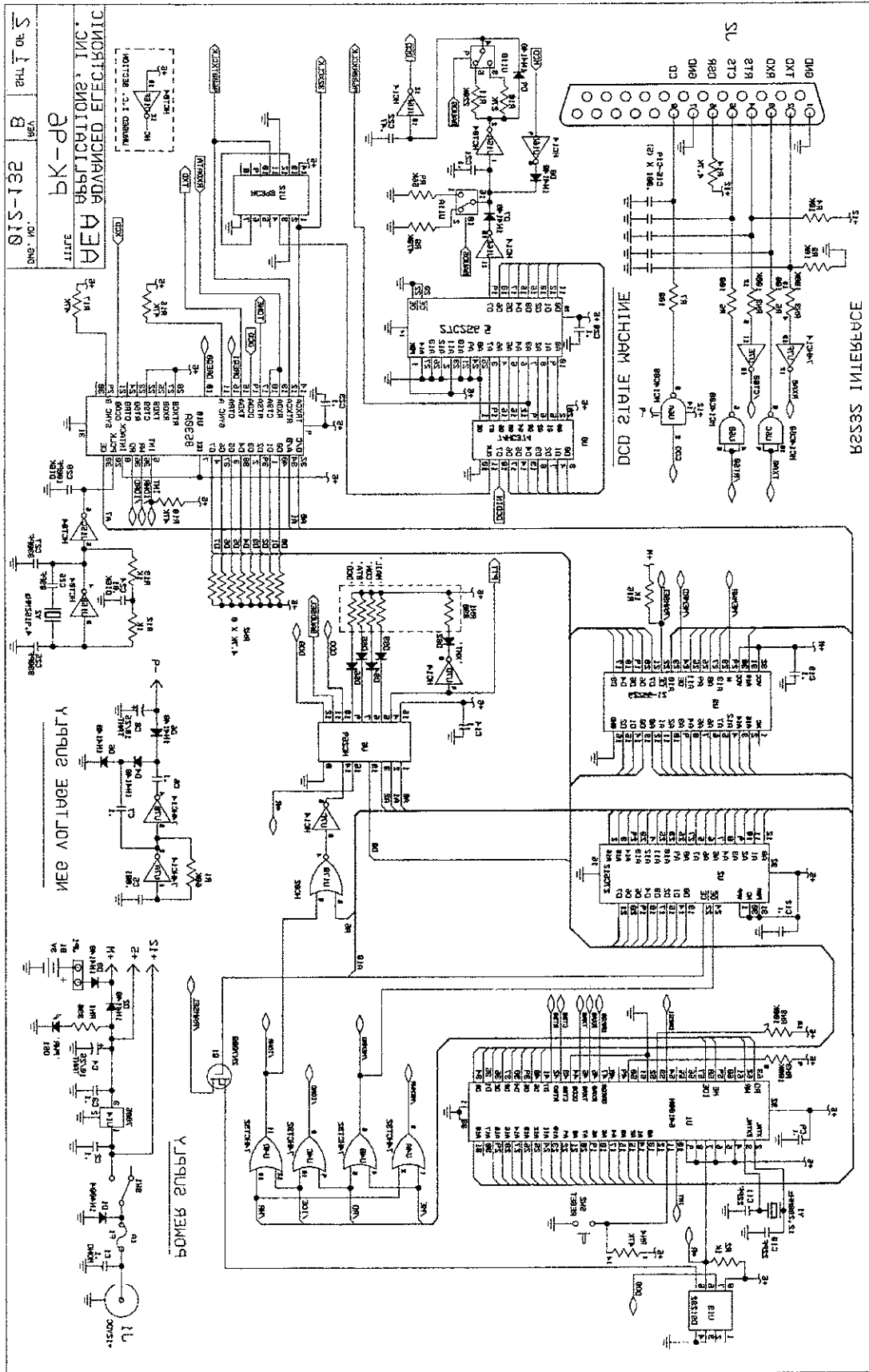

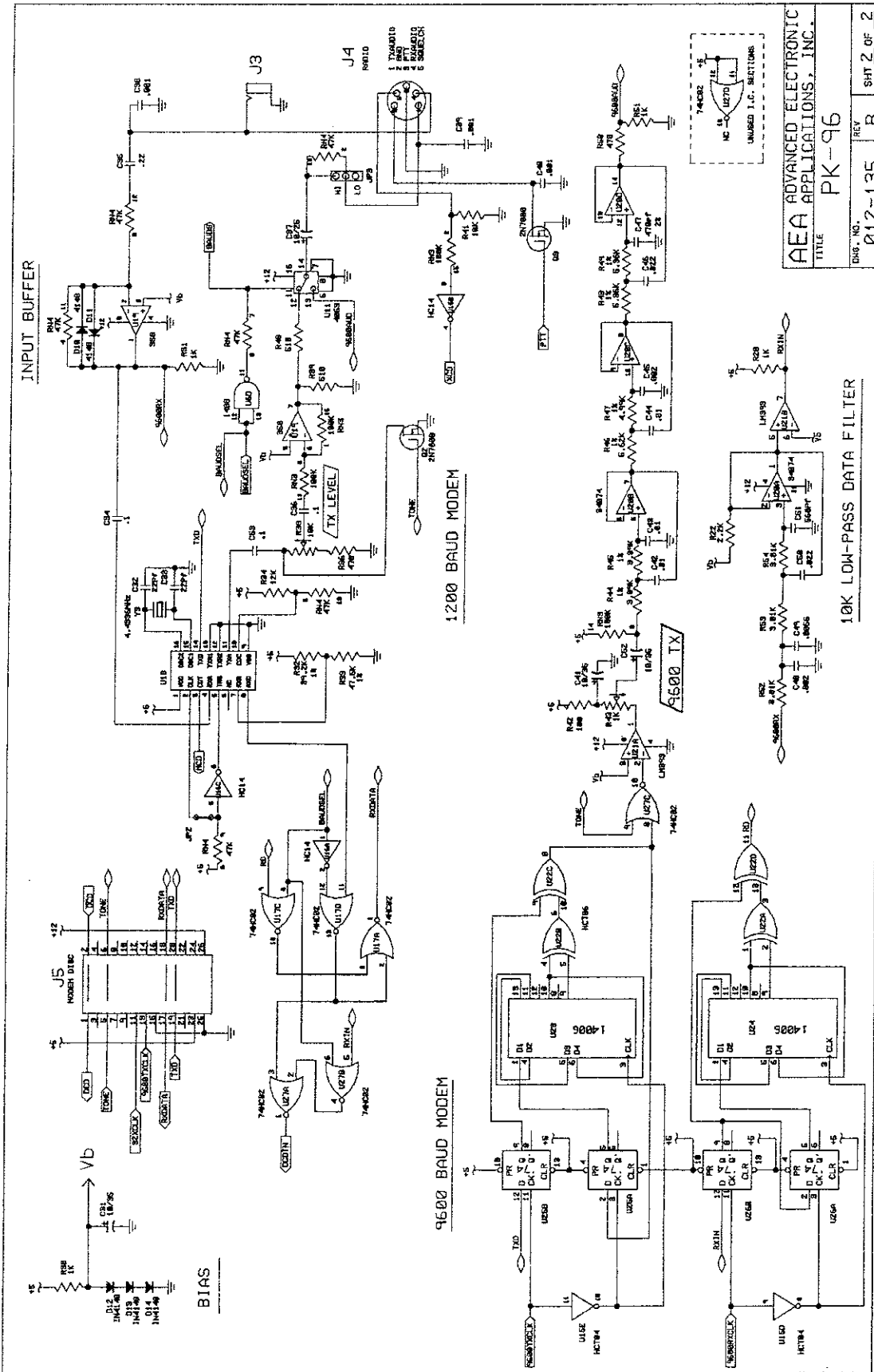

AEA ADVANCED ELECTRONIC APPLICATIONS, INC.  
 TITLE PK-96  
 DRG. NO. 012-135  
 REV. B  
 SHEET 2 OF 2

---

# Appendix C: Specifications

---

## Modem Characteristics

### 1200 bps

|                        |                                                                         |
|------------------------|-------------------------------------------------------------------------|
| Modulator/Demodulator: | Texas Instruments TCM3105                                               |
| Modem Tones:           | Bell 202                                                                |
| Output Level:          | 5 - 100mV <sub>RMS</sub> into 600ΩZ, adjustable by a rear-panel control |

### 9600 bps

|                        |                                                              |
|------------------------|--------------------------------------------------------------|
| Modulator/Demodulator: | K9NG Compatible                                              |
| Output Level:          | Up to 3V <sub>p-p</sub> , adjustable by a rear-panel control |

---

## Processor System

|                      |                                    |
|----------------------|------------------------------------|
| Protocol conversion: | Zilog Z-180 (64180) microprocessor |
| RAM:                 | 32K standard; expandable to 128K   |
| ROM:                 | Up to 64K of ROM may be used       |
| Hardware HDLC:       | Zilog 8530 SCC                     |

---

## Input/Output Connections

|                      |                                                                                            |
|----------------------|--------------------------------------------------------------------------------------------|
| Radio Interface:     | 5-pin DIN connector                                                                        |
| Input/Output Lines:  | Receive audio<br>Transmit audio<br>Push-To-Talk (PTT)<br>External squelch input<br>Ground. |
| Terminal Interface:  | RS-232C 25-pin DB-25 connector                                                             |
| Input/Output:        | RS-232C with full handshake (hardware and software)                                        |
| Terminal Data Rates: | Autobaud selection of 110, 150, 300, 600, 1200, 2400, 4800 9600 and 19200 bps.             |

---

## Controls and Indicators

|               |                                     |
|---------------|-------------------------------------|
| Power switch  | Front panel push on/push off        |
| Status LED's: | POWER, PTT, DCD, MAIL, CON, and STA |

---

## General

|                     |                                                                 |
|---------------------|-----------------------------------------------------------------|
| Power Requirements: | +13VDC (12 - 16VDC) @ 400mA                                     |
| Mechanical:         | 15.57cm x 18.8cm x 3.43cm<br>[6.13" (W) x 7.4" (D) x 1.35" (H)] |
| Weight:             | 544g (1.2 lbs.)                                                 |

# Appendix D: Upgrading the PK-96

## Overview

The PK-96 comes standard with a 18K mailbox (32K RAM). However, you can purchase a replacement EPROM and a larger RAM chip from Timewave, upgrade (part# A.06250), to increase the mailbox size to 100K (128K RAM). To order your upgrade, call us at (651) 222-4858

---

### NOTE:

*If you are using the battery to backup your RAM, this upgrade will cause you to lose all of your settings and mail. You should print these out or capture them to disk using your terminal program.*

---

## Installation

1. Turn off the PK-96 and remove all of its connected cables.
2. Remove the four screws securing the cover to the PK-96, then set the cover aside.
3. Locate I.C. chips U2 and U3. Note the orientation of each chip's notch, then carefully remove the chips, avoiding damage to their sockets and nearby components.
4. Remove the new U2 ROM (27C512) from its protective foam square and—making sure that the notch is pointed in the same direction as the original U2 chip was—press it firmly into U2's socket with your thumb. **Important:** Make *very* sure that you don't bend or break any of the chip's pins and that they're all straight and inside their respective socket holes. Install the new U3 RAM chip (128K x 8 SRAM) the same way.
5. Reconnect all of the PK-96's cables, boot your computer's TNC communications program, turn on the PK-96, perform the autobaud routine as called out in *Chapter 2 — System Start-up and Loop-back Test*, then enter MDCHECK after the cmd: prompt—you should see the following message:

```
[AEA PK96] 103820 free (B,E,K,L,R,S) >
```

If you receive this message, turn off the PK-96 and replace its cover.

If your PK-96 doesn't respond with the above message, check:

- That the new chips are firmly seated in their sockets and that all the pins are straight and in their respective holes.
- That the power and computer cables are reconnected.

If, after checking the above, your PK-96 *still* doesn't operate correctly, call Timewave's Tech Support for assistance at (651) 222-4858

# Appendix E: Understanding High Speed Modems

This addendum is to help you become more familiar with the high-speed RF modems.

## PK-96 connections

- **PTT:** FET pull to ground protected up to 60V—good for several hundred milliamps continuous duty, 1A light duty.
- **GND:** Good ground required.
- **SQUELCH:** May be used if radio provides this connection, but not required because of the DCD circuitry, which looks for a coherent clock running at the data rate the modem is set to. This is actually the best method of detecting squelch since it truly detects the presence of data.
- **TX AUDIO:** This port is the output for both 1200 bps and 9600 bps transmit 'audio'. At 1200 bps, this is Audio Frequency Shift Keying tones (1.2 kHz and 2.2 kHz); at 9600 bps, this is raw data that has been lightly filtered to reduce harmonics produced by the data.
- **RX AUDIO:** This port is the input for both 1200 bps and 9600 bps receive 'audio'. Typically, this will be the speaker output for 1200 bps use and raw discriminator audio for 9600 bps use.

## More on TX and RX 'Audio'...

Understanding the differences between 1200 bps and 9600 bps 'audio' is essential for successful use of the PK-96. The way in which each modem receives data and transmits data is very different, and each has its own requirements for proper operation.

### Some audio basics first...

All FM radio systems that transmit and receive voice grade audio use a scheme called 'audio emphasis' for reducing the amount of transmission noise. This applies to amateur and commercial radio, as well as broadcast radio. The audiophile's term for 'audio emphasis' is Dolby noise reduction; it works the same way to remove noise from cassette recordings.

The audio band is 300 Hz to 3.4 kHz on radio and telephone systems. Most of the energy in a human's voice is between 350 and 600 Hz for males and 500 to 750 Hz for females. During transmission, audio will pick up noise (atmospheric, man-made, etc.) which is typically higher in frequency (1.5+ kHz) than voice audio. Since noise consists primarily of high frequency components, it will affect the higher frequency components of a person's voice.

You might ask, "Why don't we just filter off the high frequency noise instead of 'emphasizing' the audio?" The answer is that to maintain what human ears perceive as 'natural' audio, the high frequency portion of a person's voice must be accurately reproduced. It turns out that the higher frequency components of a person's voice enhance the intelligibility of their voice. Because of this, filtering off the high frequency components will alter the usefulness of the radio system. The average person who hears bandlimited voice audio will complain that 'you sound like you're in a barrel' when you talk to them.



'Emphasizing' is a process by which the level of audio is altered based on its frequency. Audio transmitted on the air is referred to as 'pre-emphasized'—the higher the frequency, the higher the transmitted level. To return the audio to its 'natural' state, the receiver 'de-emphasizes' the audio before sending it to the speaker. De-emphasizing the audio amplifies the low frequencies and attenuates the high frequencies.

The idea here is this: since we attenuated the high frequency components, we also attenuated the noise that was picked up in the transmission path, thus increasing the SNR of the system from what it would have been without emphasis.

The following graphs show pre-emphasis and de-emphasis at work:

### **Pre-Emphasis**

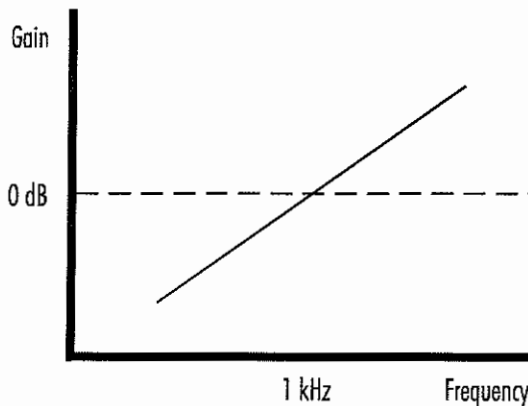

### **De-Emphasis**

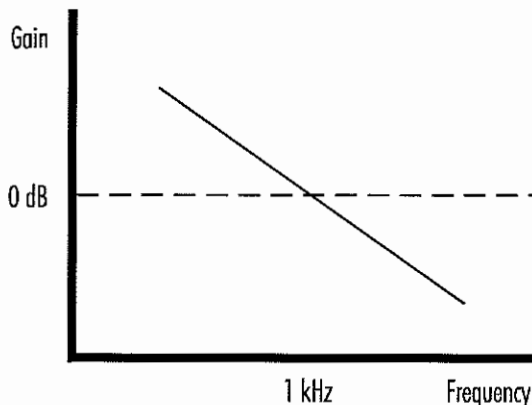

The emphasis curve is steep—it amplifies or attenuates at 6db/octave. Notice that at 1 kHz, the level is the same regardless of whether or not the signal has been pre-emphasized or de-emphasized. This is the reference level used to make all measurements. Because of the steep emphasis function, all transmit and receive level adjustments must be made using the 1kHz reference!

Now that we understand how audio is transmitted over an RF path, it is time to look at the differences between 1200 bps data and 9600 bps data being sent over the radio.

## **1200 bps**

1200 bps data, for all practical purposes, is the same as voice audio and therefore must be emphasized when sent on the air. It should be obvious that pre-emphasis and de-emphasis have to travel in pairs. Because of the modem hardware, the mark and space tones must be fairly close to the same level for the data to be properly demodulated. This is why it is very important that the 1200 bps AFSK inputs and outputs be connected to the emphasized points in the radio. On most radios, the input that produces pre-emphasized audio on the channel is the microphone audio input, and the output that produces flat audio (de-emphasized received au-

dio) is the speaker output or the 'volume high' pin in the speaker driver. As can be seen by the above graphs, and considering that the 1200 bps mark/space tones are 1.2 and 2.2 kHz, you can see that improperly adjusted emphasis—or lack of emphasis—on either side of the radio link will cause serious problems with the data retrieval.

### Data Demodulator

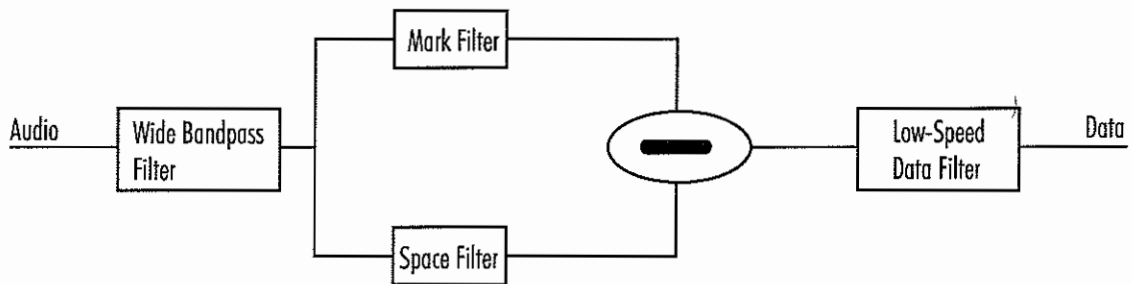

## Theory of Operation for the Demodulator

Raw, de-emphasized audio comes in from the left ('Audio') and is processed by a wide bandpass filter. This filter has linear phase response, is centered on the carrier frequency (1.7 kHz in this case), and is wide enough to allow both the mark and space tones through and some of the harmonics associated with shifting the tones. The filtered audio is then split and passes through a pair of 'matched' filters, each of which is centered on either the mark or space tones (1.2/2.2 kHz) and only consists of light filtering (linear phase response). The object of these two filters is simply to be able to distinguish between the two tones—if the filter gets too narrow or the order is too great, the filter will not be able to respond quickly enough to allow the tones to pass through it. The difference between the two filters is then calculated and the result is fed through a low-speed data filter (a low-pass filter with the cut-off frequency set to the baud rate). This filter eliminates the carrier frequency from the recovered data and cleans up the signal.

It should be noted that the reason emphasis is so important to this type of modem is that—since the data is derived from the difference between the matched filters—any difference in modulation level will 'skew' the output of these two filters and therefore, change the edges in the recovered signal.

For example:

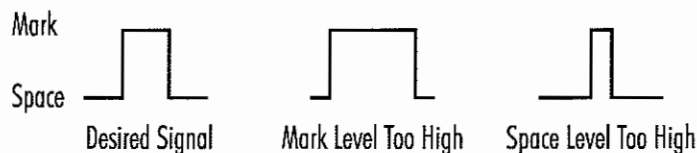

As with voice, modulation of the 1200 bps mark/space tones should be set to 3 kHz deviation on the channel.

## 9600 bps

The real trick to 9600 bps data is the data transmission. This imposes the strictest requirements on radio selection. 9600 bps data translates to a maximum frequency of 4.8 kHz (9600 bps 1010101 pattern) which will NOT pass through the mic audio circuit that attenuates signals above 3.4 kHz. In addition to this, the 9600

bps approximates a square wave signal which produces strong odd harmonics *that are necessary to the successful recovery of the data!* The harmonics also need to be transmitted so that the square-wave may be recovered at the receiving end. This is tricky—if the harmonics are attenuated too much, the signal at the receiver will end up a sine wave (lack of clean edges), yet if the harmonics are too strong, the transmitted bandwidth is wider than it needs to be and will bleed into adjacent channels.

At the other end, we have to deal with long streams of 1's and 0's which are low frequency in the audio world. The transmit injection point in the radio must be able to deal with frequencies approaching DC (0 Hz)—again, something that the mic audio input is incapable of! This requirement is actually the hardest one to deal with. In theory, we need a transmitter that is capable of moving off frequency and staying there indefinitely. To do this, we need to have a directly coupled transmit path inside the radio. Any capacitors in the transmit path will increase the lowest passing frequency allowed to the transmitter, which is undesirable. It is much easier to use radios with crystals than synthesized radios, since synthesized radios have phase-locked loops (PLL's) that keep the transmitter on frequency. Crystal-controlled radios do not have PLL's that are trying to put the transmitter back on frequency, and therefore do not have this problem.

Since it is the synthesizer's job to keep the radio on frequency, it is a problem in regards to transmitting data that requires the transmitter to be some distance off frequency for an extended period of time. The PLL's loop consists of a low-pass filter that provides feedback to the phase lock hardware telling it whether the output frequency is off-frequency or not. This process is fairly slow moving in order to keep the PLL from modulating the signal itself with quick changes in its output. What this all means is that the PLL will allow the transmitter to be off frequency for a short period of time, and it is fairly sluggish to adjust for the frequency error. This time constant differs between radios, making it tough to figure out which radios will work well with high-speed data transmissions. The longer the time constant, the longer it will take for the data to drop back to the carrier frequency—the more 'square' the data will look.

We have no control of the data sent by the modem over the air—it could be a continuous stream of 1's or 0's, which would require the transmitter to stay off frequency for a great length of time. Because of the PLL, this is *not* going to happen with a synthesized radio, so we need some way of altering the data to guarantee that the data changes often enough to keep the PLL happy. This is the purpose of the data scrambler/descrambler circuitry in the modem. The scrambler multiplies the outgoing data stream by a polynomial and the descrambler divides the incoming data stream by the same polynomial to convert the data back to the original code. The scrambler does not come for "free"—any bit errors that are encountered propagate through the polynomial, affecting more bits than the one with the error in it.

As mentioned above, receiving the 9600 bps data requires a wide receiver front-end capable of passing the harmonics which square up the signal. Narrow filters on the front-end of the radio will remove too many of the harmonics, thereby removing the corners of the square-wave and making it hard to recover the data. The wide-band signal required by the modem is far too wide to make it to the speaker of the radio-discriminator audio required for 9600 bps data reception.

9600 bps data should be transmitted on the air at 2.4 kHz deviation for maximum efficiency. True FSK signals require modulation levels equal to the highest transmitted frequency (4.8 kHz in this case), but MSK signals require half of the modulation level of FSK signals for maximum efficiency. It is imperative that the level on the air is properly set! We cannot tell you to adjust it 'by ear' based on unsquelched noise being 100%. Unsquelched noise ranges from 2 to 5 times that of properly modulated signals, based on the radio being used. Not only will 'by ear' adjustments cause problems in actual operation, but it will in fact cause some customers to operate illegally by interfering with adjacent channel users!

It should be apparent by now that the 9600 bps ports and 1200 bps ports on the radio are *not* interchangeable without additional hardware in the modem (pre-emphasis and de-emphasis circuits).

Because of the requirements to pass the harmonics of the 9600 bps signal, and the ability of the radio to bleed into adjacent channels if the level is too high, the modulation level of the 9600 bps signal is far more critical to system performance than that of the 1200 bps signal.

---

# Appendix F:

## Product Warranty

Timewave Technology Inc. products carry the following warranty:

Timewave hardware products are warranted against defects in materials and workmanship. If Timewave receives notice of such defects during the warranty period, Timewave shall, at its option, either repair or replace hardware products which prove to be defective.

Timewave software and firmware products which are designated by Timewave for use with a hardware product are warranted not to fail to execute their programming instructions due to defects in materials and workmanship. If Timewave receives notice of such defects during the warranty period, Timewave shall, at its option, either repair or replace software media or firmware which do not execute their programming instructions due to such defects. Timewave does not warrant that operation of software, firmware, or hardware shall be uninterrupted or error free.

The warranty period for each product is one year from date of shipment.

---

### Limitation of Warranty

The foregoing warranty shall not apply to defects resulting from:

1. Improper or inadequate maintenance by the Buyer;
2. Buyer-supplied software or interfacing;
3. Unauthorized modification or misuse;
4. Operation outside the environmental specifications of the products;
5. Improper site preparation and maintenance.

---

### Exclusive Remedies

The remedies provided herein are the Buyer's sole and exclusive remedies. In no event shall Timewave be liable for direct, indirect, special, incidental or consequential damages (including loss of profits) whether based on contract, tort, or any other legal theory.

---

# Appendix G:

## PK-96 TheNet Node Option

Timewave's PK-96 can now be a component in a TheNet network at 1200 or 9600 bps. The TheNet capability of the PK-96 allows node-builders to add a 9600 bps port to an existing mountain-top network quickly and easily.

The PK-96 you have right now is able to connect to a TheNet network at 1200bps. Being able to connect to a TheNet network allows a packet user on one frequency to connect with a network located on a hill and communicate with other packet users on different frequencies. The network allows users to communicate with people they otherwise couldn't because of geographic obstacles. The network also allows cross-frequency communication so all users can communicate with each other in one forum, regardless of frequency.

Dave Roberts, G8KBB, has written a version of TheNet X1J specially designed for the PK-96. The PK-96 can now be a connected part in the network. A special version of TheNet is available for the PK-96. This means that network builders can add a 9600 bps port to an existing mountain-top network quickly. All the benefits associated with using a network have been available at 1200 bps for quite a while, but now they are available at 9600 bps. Once a PK-96 is installed in a network, all 9600 bps users can find others to communicate with in one forum.

For more information on how you can acquire TheNet software for the PK-96, contact Timewave at (651) 222-4858.



# Index

## Symbols

3RDPARTY command 26, 77

8BITCONV command 27, 77

## A

Abbreviation. *See* the specific abbreviation

ack xii

command 27–28, 77

ACRDISP command 28, 77

s command 77

ADDRESS command 28

AFILTER command 28–29, 77

ALFDISP command 29, 77

ALFPACK command 28, 29, 77

APRS 109–116

APRS Adapter Cable 114

Dual Port Mode 115

Hardware Single Port Mode 114

Loading APRS software 112

Registered versions 112

Ultimeter II use 116

Arguments

Boolean 25

Numeric 25

Text or String 25

ASCII 50

AUDELAY command 29–30, 77

Auto-Forwarding 107–108

AUTOBAUD command 30, 77

Autobaud Routine 10

AWLEN command 30, 77

AX25L2V2 command 30, 77

AXDELAY command 30–31, 31, 77, 95

AXHANG command 31, 77, 95

## B

Back Panel

1200 TX 3

9600 TX 3

RADIO 3

RESET button 3, 5

RS-232 3

Pin Assignments 5

RX Audio 12, 150

TX LEVEL 16, 150

Baud

Autobaud command 30

Autobaud routine 30

TBaud (terminal baud) command 71

BBSmsgs 31

BBSMSG command 77

BEACON command 31, 31–32, 77, 82, 94

BKONDEL command 32, 77

BTEXT command 32, 77

## C

CALIBRATE command 15–16, 32–33, 77

Calling CQ 85

CANLINE command 33, 77

CANPAC command 33, 77

CASEDISP command 34, 77

CBELL command 34, 77, 85

CFROM command 34, 77

Changing Commands

Channel Switching *see* CHSWITCH command

CHCALL command 34–35, 77, 92

CHDOUBLE command 35, 77

CHECK command 24, 35, 77, 97

CHSWITCH command 36, 77, 91

cmd: Prompt 126

CMDTIME command 36, 77

CMSG command 36–37, 77

CODE command 37, 77

Collision Avoidance 97, *also see* DAMA

Commands

Arguments 25

DAMA 75

GPS 49

List of 25

COMMAND command 37, 77

Command Mode 80

Commercial 51, 117

Commercial GPS adapter cable 51

GPMode3 command 51

Wireless Data/Location Tracking 117

Computer/Software 8, *also see: PC PakRatt Lite, PC*

*PakRatt for Windows, PC PakRatt II for DOS, MacRatt*

CON status LEDs 3

Connections

APRS Adapter Cable connections 114

Basic connections 13

Computer connections 5  
 GPS (commercial) Adapter Cable connections 119  
 GPS receiver connections 113  
 Power 4  
 Radio connections 12, 16, *Appendix A*  
 Ultimeter II connections 116  
 CONMODE command 37, 77  
 CONNECT command 37-38, 77  
 Connect request 38  
 Connecting 113, 116, 119  
 Connecting to another station 83-84  
 CONPERM command 38, 77  
 CONSTAMP command 38, 77  
 CONVERSE command 38, 77  
 Converse Mode 80  
 CPACTIME command 39, 77  
 CSTATUS command 39, 77, 92-93  
 CTEXT command 39, 77, 84-85  
 CTRL xii  
 CUSTOM command 40, 77  
 Customer Service/Technical Support *Appendix F, Chap. 8*

---

## D

DAMA 75, 97  
 DAYSTAMP command 41, 77  
 DAYTIME command 41, 77  
 DB-25F *see Serial Port*  
 DB-9 *see Serial Port*  
 DCD Status LED 3  
 DCDCONN command 41, 77  
 DELETE command 42, 77  
 Delay  
     AUDELAY command 29  
     AXDELAY command 30  
     AXHANG command 31  
     TXDELAY command 72  
 DFROM command 42, 77  
 DIGIPEAT 42  
 DIGipeat 42  
 Digipeating 90  
 DISCONNE command 42, 77  
 DISPLAY command 43-45, 77  
 DWAIT command 45, 78

---

## E

ECHO command 45, 78  
 Error Messages  
     \*\*\* call busy 125  
     \*\*\* connect request:call1 125  
     \*\*\* Disconnected: call 125  
     \*\*\* Retry count exceeded 125  
     \*\*\* Transmit data remaining 124  
     \*\*\* What? 125

?already connected to that station 124  
 ?bad 124  
 ?callsign 124  
 ?channel must be 0-9 124  
 ?clock not set 124  
 ?different connectees 124  
 ?need ALL/NONE/YES/NO 124  
 ?need MYcall 124  
 ?not enough 124  
 ?not while connected 124  
 ?not while disconnected 124  
 ?range 124  
 ?too long 124  
 ?too many 124  
 ?VIA 124  
 ?What? 124  
 bbRAM scanned, checksum failed! 126  
 ERROR: Subroutine, Bank, Addr 126  
 FRMR rcvd: xx xx xx 125  
 FRMR sent: xx xx xx 125  
 LINK OUT OF ORDER, possible data loss 124  
 Message not found 125  
 Need callsign 125  
 No free memory 126  
 Not your message 126  
 Packet Link Status Messages 125  
 PK-96 is using default values 126  
 ROM error, checksum \$xxxx 126  
 Serial port configuration will change on next  
     REST 124  
 too many packets outstanding 125  
 TXdelay too short 125  
 WARNING: AUdelay >TXdelay 125  
 WARNING: Beacon too often 125  
 WARNING: CHECK/FRack too small 125  
 WARNING: RESptime/FRack too large 125  
 ESC xii  
 ESCAPE command 45, 78  
 EXPERT command 1, 45-47, 78

---

## F

FLOW command 78  
 FRACK command 23, 48, 78, 92  
 FREE command 48, 78  
 Frequencies 80  
 FRICK command 48-49, 78, 92  
 FSK xii  
 FULLDUP command 49, 78



---

**G**

Gateway (Nodes) 86  
 GPS commands  
   GENDchar 49, 78  
   GINIText 49, 78  
   GLOCtx 50, 78  
   GNMEA1 50, 78  
   GNMEA2 50, 78  
   GPOLLcal 50, 78  
   GPSAuto 50, 78  
   GPSMode 51, 78  
   GREMprog 52, 78  
   GSYMChar 52, 78  
   GUNStart 53, 78  
 GPS 109  
 GUSERS command 53, 78

---

**H**

Hardware Single Port Mode (HSP) 109, 114  
 HBAUD command 53, 78, 93  
 HEADERLN command 53, 78  
 HF xii  
 HID command 53-54, 78  
 HOMEBBS command 54, 78  
 HOST command 54, 78  
 HPOLL command 54, 78

---

**I**

ID command 55, 78  
 IF Filters 17  
 ILFPACK command 55, 78  
 Indicators  
   CON light 3, 4  
   DCD light 3, 4  
   MAIL light 3, 4  
   PWR light 3, 4-5  
   STA light 4-5  
   XMT light 3  
 IO command 55

---

**K**

K command 78. *See also* CONVERSE command  
 KILONFWD command 55, 78, 108  
 KISS command 55, 78  
 Kiss Mode 80  
 KISSADDR command 56, 78

---

**L**

LASTMSG command 56, 78, 107  
 lf xii  
 List of Commands 24  
 Loop-back test 9

---

**M**

Macintosh 5, 9  
 MacRatt 9  
 Mailbox commands  
   3rdpart command 26, 77  
   Homebbs command 54, 78  
   Kilonfwd command 55, 78  
   Lastmsg command 56, 78  
   MailDrop command 57, 78  
   MDcheck command 59, 78  
   MDmon command 59, 78  
   MDprompt command 59, 78  
   Mheard command 60, 78  
   Mmesg command 61, 78  
   Mtext command 63, 78  
   Myalias command 63, 79  
   Mycall command 64, 79  
   Mymail command 64, 79  
   Reinit command 69, 79  
   Reset command 69, 79  
   Restart command 69, 79  
 MAILDROP command 57, 78  
 MailDrop Upgrade 149  
 master 97, 112  
   *also see DAMA*  
 MAXFRAME command 24, 57, 78  
 MBELL command 57, 78  
 MBX command 57-58, 78  
 MCON command 58, 78  
 MDCHECK command 59, 78  
 MDIGI command 59, 78  
 MDMON command 59, 78  
 MDPROMPT command 59, 78, 101  
 MEMORY command 60  
 MFILTER command 60, 78, 94  
 MFROM command 60, 78  
 MHEARD command 60, 78, 82-83  
 MID command 61, 78  
 MMSG command 61, 78  
 MONITOR command 61-62, 78  
 Morse ID 98  
 MPROTO command 62, 78  
 MRPT command 62, 78  
 mS xii  
 MSTAMP command 62, 78  
 MTEXT command 63, 78, 101  
 MTO command 63, 78  
 MXMIT command 63, 78  
 MYALIAS command 63, 79  
 MYCALL command 26, 64, 79

MYGATE command 64, 79  
MYMAIL command 64, 79

---

## N

n xii  
nack xii  
NET/ROM 86  
NEWMODE command 64, 79  
Node Operation  
    General Theory 86–87  
    Operating as a Node 87–89  
    Stay Command 89  
NOMODE command 65, 79  
NUCR command 65, 79  
NULF command 65, 79  
NULLS command 65, 79  
Numerical Argument , *see arguments*

---

## O

OPMODE command 79

---

## P

Packet Mail , *also see MailDrop*  
Packet/GPS configurations 112, *also see GPS & APRS*  
PACLEN command 65, 79, 96  
PACTIME command 66, 79  
PARITY command 66, 79  
PASS character 95–96  
PASS command 66, 79  
PASSALL command 67, 79  
PC-PakRatt Lite 9  
PC-PakRatt for Windows 8  
PC-PakRatt-II 8  
PERSIST command 24, 67, 79  
PK command 67  
PPERSIST command 67, 79  
PRCON command 68  
PROUT command 68  
PTT xii, 150

---

## R

Radio Cable Connections  
    Ground 13, 13–14  
    Microphone Audio 13, 13–14  
    PTT 13, 13–14  
    Receive Audio 13, 13–14

Shield/Drain Wire 13–14  
Squelch Input 13–14  
Radio Modifications for 9600 baud Operation  
    Alinco 19  
    GE Phoenix 19  
    ICOM 19, 20  
    Kenwood 20, 20–21  
    Motarola MICOR 21  
    Motarola Mitrek 21–22  
    TEKK 22  
    Yaesu 22, 22–25  
RAWHDLIC command 68, 79  
REDISPLA command 68, 79  
registered version of APRS 114  
REINIT command 26, 69, 79  
Reinitialization 5, *also see REINIT, RESTART, or RESET*  
RELINK command 69, 79, 97  
Remote programming 52, *also see GREMprog or GPS*  
remotely polled 109  
RESET command 26, 69, 79  
RESPTIME command 23, 69, 79  
RESTART command 26, 69, 79  
RETRY command 24, 70, 79  
Reverse-Forwarding 107, 108  
ROSE 86

---

## S

Selective Monitoring 93  
Sending Mail 104  
SENDPAC command 70, 79  
Serial Port 5  
    slave 75, 97  
SLOTTIME command 24, 70, 79  
Software *see PakRatt or MacRatt*  
SQUELCH command 14, 70, 79  
Stand Alone Tracking 109, 110, 111, 112, 114  
START command 70, 79  
STAY command. *See also* Node Operation: Operating as a Node: Stay Command  
STOP command 71, 79

---

## T

TBAUD command 71, 79  
TCLEAR command 71, 79  
TCP/IP 86

Terminal Commands  
    ACRDISP 28, 77  
    AFILTER 28, 77  
    ALFDISP 29, 77  
    AUTOBAUD 30, 77  
    AWLEN 30, 77  
    BKONDLE 32, 77

CANLINE 33, 77  
 CASEDISP 34, 77  
 CMDTIME 36, 77  
 COMMAND 37, 77  
 CONVERSE 38, 77  
 CUSTOM 40, 77  
 DAYTIME 41, 77  
 DELETE 42, 77  
 DISPLAY 43, 77  
 ECHO 45, 78  
 ESCAPE 45, 78  
 FLOW 47, 78  
 HOST 54, 78  
 HPOLL 54, 78  
 KISS 55, 78  
 NOMODE 65, 79  
 NUCR 65, 79  
 PARITY 66, 79  
 REDISPLA 68, 79  
 REINIT 69, 79  
 RESET 69, 79  
 RESTART 69, 79  
 START 70, 79  
 STOP 71, 79  
 TBAUD 71, 79  
 TRANS 72, 79  
 TRFLOW 72, 79  
 TXFLOW 73, 79  
 UNPROTO 74, 79  
 UBIT 73, 79  
 XFLOW 76, 79  
 XOFF 76, 79  
 XON 76, 79  
 Text argument 25  
 TheNet Appendix G  
 TIME command 79. *See also* DAYTIME command  
 TRACE command 71-72, 79  
 TRANS command 72, 79  
 Transceiver  
   adjustments 15  
   connections 12, 16  
   Modifications for 9600bps 19  
   specific connections *Appendix A*  
 Transferring Files 98  
 Transparent Mode 80, 98  
 TRFLOW command 72, 79  
 TRIES command 72, 79  
 Troubleshooting 120  
 TX Level 13  
 TXDELAY command 23, 72, 79, 94-95  
 TXFLOW command 73, 79

---

## U

UBIT command 73-74, 79  
 UCMD command 79  
 UHF xii  
 ULTIMETER II 51, 111, 112, 113, 117

Unintentional Disconnects 97  
 UNPROTO command 74, 79  
 Upgrading the PK-96 149, Appendix G  
 Uplink 75, 97  
 Uplink 75  
 USERS command 75, 79, 91

---

## V

Varactor diode 18  
 VHF xii  
 VHF command 79  
 Voice Repeaters 95

---

## W

Warranty *see Appendix F*  
 WHYNOT command 75-76, 79  
 Wireless Data/Location Tracking Applications 117, *also see commercial*

---

## X

XFLOW command 7, 8, 76, 79  
 XMITOK command 76, 79  
 XOFF command 76, 79  
 XON command 76, 79

---

## Z

ZFREE command 79  
 ZSTATUS command 79

This page intentionally left blank.